

HY202XX01

20 CHAR X 2 LINE

1. EXTERNAL DIMENSION AND DISPLAY PATTERN

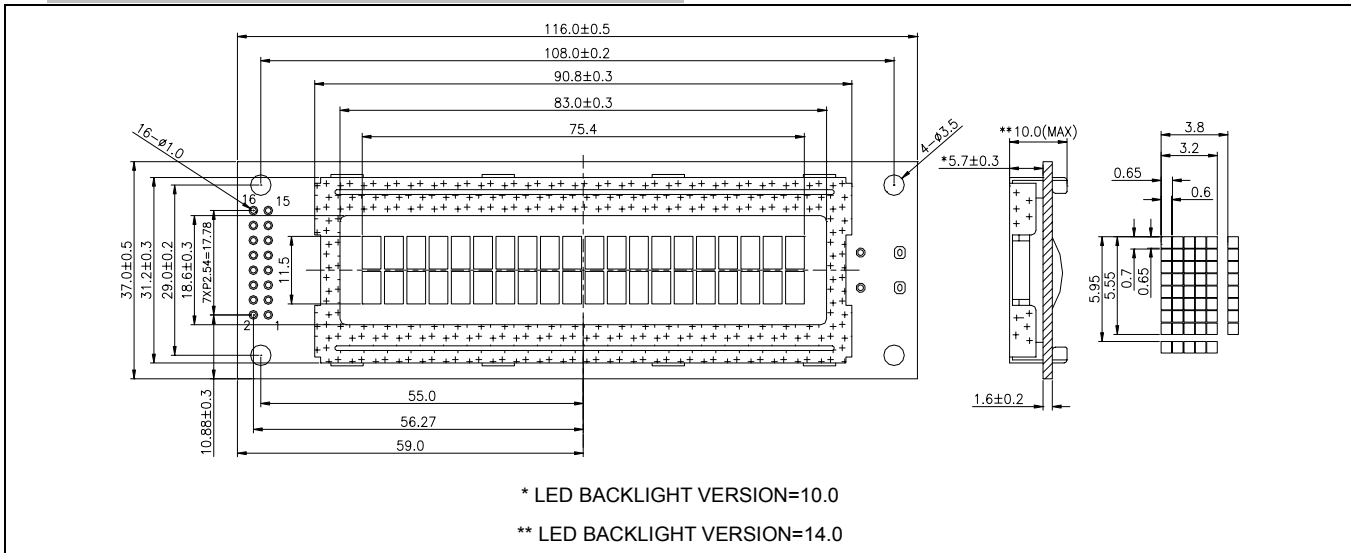

2. MECHANICAL DATA

ITEM	SPECIFICATION	UNIT
Module Size (W×H×T)	116.0×37.0×10.0 (LED:14.0)	mm
Viewing Area (W×H)	83.0×18.6	mm
Character Font (W×H)	5×7 with Cursor	dots
Character Size (W×H)	3.2×5.55	mm
Character Pitch (W×H)	3.8×5.95	mm
Dot Size (W×H)	0.6×0.65	mm

3. PIN CONFIGURATION

PIN	SYMBOL	SIGNAL DESCRIPTION
1	V _{SS}	GND (0V)
2	V _{DD}	Power Supply
3	V ₀	Supply Voltage LCD Driving
4	RS	Register Select Low = Instruction, High = Data
5	R/W	Read/Write Low = MPU to LCM, High = LCM to MPU
6	E	Enable R/W= Low : Data are talking over at falling edge R/W=High : Data can be read at E=1
7 ~ 14	DB ₀ to DB ₇	Data Bus-Software Selectable 4 or 8bit Mode
15	A	Anode of LED Unit
16	K	Cathode of LED Unit

4. BLOCK DIAGRAM

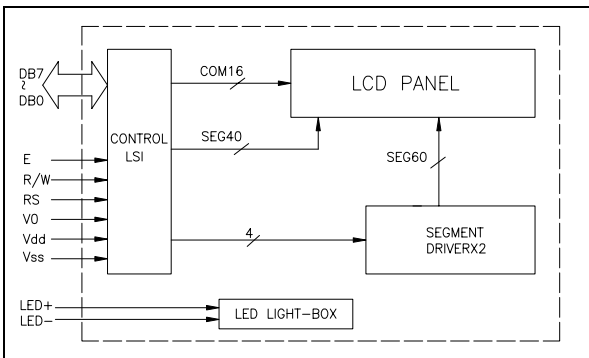

5. ABSOLUTE MAXIMUM RATINGS

PARAMETER	SYMBOL	MIN.	MAX.	UNIT
Supply Voltage (Logic)	V _{DD} - V _{SS}	-0.3	7.0	V
Supply Voltage (Driver)	V ₀	V _{DD} - 12	V _{DD} + 0.3	V
Input Voltage	V _{IN}	-0.3	V _{DD} +0.3	V

6. ELECTRICAL CHARACTERISTICS (Ta=25°C)

ITEM	SYMBOL	CONDITION	SPEC. VALUE			UNIT	
			MIN.	TYP.	MAX.		
Supply Voltage (Logic)	V _{DD} - V _{SS}		4.5	5.0	5.5	V	
Supply Current (Logic)	I _{DD}	V _{DD} =5V	-	0.8	2.0	mA	
Input Voltage	"HIGH"	V _{IH}	-	2.2	-	V _{DD}	V
	"LOW"	V _{IL}	-	-0.3	-	0.6	V
Output Voltage	"HIGH"	V _{OH}	-I _{OH} =0.2mA	2.4	-	-	V
	"LOW"	V _{OL}	I _{OL} =1.2mA	-	-	0.4	V
LCD Operating Voltage	V _{DD} - V ₀	V _{DD} =5V, Ta=25°C	4.2	4.4 (7.8)	4.6	V	
Supply Voltage LCD Drive	V ₀		-	1.0	1.5	mA	

Note : () Value is high Reliability type

7. BACKLIGHTING CHARACTERISTICS (Ta=25°C) LED

ITEM	SYMBOL	CONDITION	MIN.	TYP.	MAX.	UNIT
Supply Voltage	V _{LED}	-	-	4.2	4.6	V
Power Consumption	P _{LED}	I _F =140mA	-	590	-	mW
Luminous	I _V	I _F =140mA	-	200	-	cd/m ²