

Stereo Audio Taper Potentiometers with Pushbutton Interface

MAX5456/MAX5457

General Description

The MAX5456/MAX5457 dual, logarithmic taper digital potentiometers feature a simple pushbutton interface that controls volume and balance in audio applications. Each potentiometer has 32 tap points and replaces mechanical potentiometers. Refer to the MAX5408–MAX5411 data sheet for SPI™ versions of the MAX5456/MAX5457.

Use the MAX5456/MAX5457 digital inputs with momentary contact single-pole/single-throw (SPST) pushbutton switches. Each input includes internal debounce circuitry and a 50kΩ pullup resistor.

The MAX5456/MAX5457 advance the wiper setting once per button push. Maxim's proprietary SmartWiper™ control eliminates the need for a microcomputer to increase the wiper transition rate. Holding the control input low for more than 1s advances the wiper at a rate of 4Hz for 4s and 16Hz per second thereafter.

The MAX5456/MAX5457 provide temperature coefficients of 50ppm/°C end-to-end and 5ppm/°C ratiometric and a nominal resistance of 10kΩ per potentiometer. An integrated click/pop suppression feature minimizes the audible noise generated by wiper transitions. The typical total harmonic distortion plus noise (THD+N) for these devices is 0.01%.

The MAX5457 features a 3-button interface with a MODE input that toggles between volume- and balance-control modes. An LED output indicates volume or balance mode. The MAX5456 features a 4-button interface with separate inputs for up and down volume controls and left and right balance controls.

The MAX5456/MAX5457 are available in 16-pin QSOP and 16-pin TQFN packages and are specified over the extended (-40°C to +85°C) temperature range.

Applications

- Stereo Volume Control
- Fading and Balancing Stereo Signals
- Stereo Blending and Mixing

Typical Application Circuits and Selector Guide appear at end of data sheet.

SPI is a trademark of Motorola, Inc.

SmartWiper is a trademark of Maxim Integrated Products, Inc.

Features

- ◆ SmartWiper Control Provides Accelerated Wiper Motion
- ◆ Debounced Pushbutton Interface with Internal Pullup Resistors
- ◆ Logarithmic Taper with 2dB Steps Between Taps
- ◆ Single +2.7V to +5.5V or Dual ±2.7V Supply Operation
- ◆ Low 0.5μA Standby Supply Current
- ◆ Clickless Switching
- ◆ 10kΩ End-to-End Fixed Resistance Value
- ◆ Mute Function to -90dB (typ)
- ◆ Power-On Reset to -12dB Wiper Position
- ◆ 32 Tap Positions for Each Wiper
- ◆ Small 16-Pin QSOP/TQFN Packages

Ordering Information

PART	TEMP RANGE	PIN-PACKAGE
MAX5456EEE	-40°C to +85°C	16 QSOP
MAX5456ETE*	-40°C to +85°C	16 TQFN
MAX5457EEE*	-40°C to +85°C	16 QSOP
MAX5457ETE*	-40°C to +85°C	16 TQFN

*Future product—contact factory for availability.

Pin Configurations

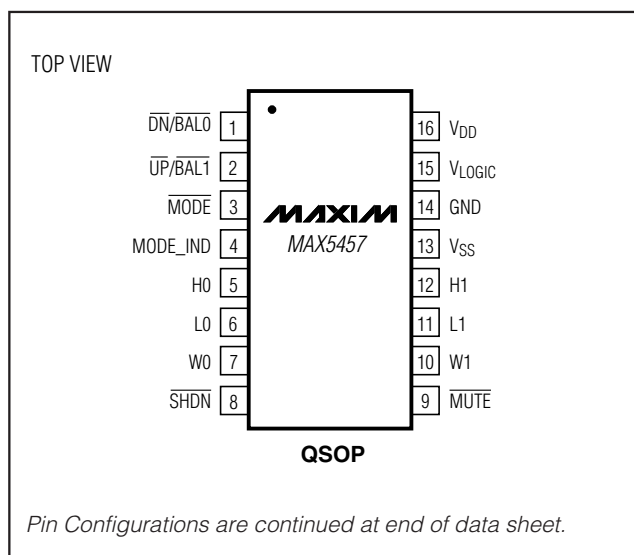

Stereo Audio Taper Potentiometers with Pushbutton Interface

MAX5456/MAX5457

ABSOLUTE MAXIMUM RATINGS

(MAX5456) SHDN, MUTE, VOLUP, VOLDN, BAL ₋ to GND.....	-0.3V to (V _{LOGIC} + 0.3V)
(MAX5457) SHDN, MUTE, UP/BAL1, DN/BAL0, MODE, MODE_IND to GND.....	-0.3V to (V _{LOGIC} + 0.3V)
H ₋ , L ₋ , and W ₋ to V _{SS}	-0.3V to (V _{DD} + 0.3 V)
V _{DD} to GND	-0.3V to +6V
V _{DD} to V _{SS}	-0.3V to +6V
V _{LOGIC} to GND.....	-0.3V to +6V
V _{LOGIC} to V _{SS}	-0.3V to +6V
V _{SS} to GND.....	-3.0V to +0.3V

Peak Current into H ₋ , L ₋ , and W ₋	±1mA
Average Current into H ₋ , L ₋ , and W ₋	±500μA
Input and Output Latchup Immunity.....	±200mA
Continuous Power Dissipation (T _A = +70°C)	
16-Pin QSOP (derate 8.3mW/°C above +70°C).....	666.7mW
16-Pin TQFN (derate 16.9mW/°C above +70°C)	1349.1mW
Operating Temperature Range	-40°C to +85°C
Junction Temperature	+150°C
Storage Temperature Range	-60°C to +150°C
Lead Temperature (soldering, 10s)	+300°C

Stresses beyond those listed under "Absolute Maximum Ratings" may cause permanent damage to the device. These are stress ratings only, and functional operation of the device at these or any other conditions beyond those indicated in the operational sections of the specifications is not implied. Exposure to absolute maximum rating conditions for extended periods may affect device reliability.

ELECTRICAL CHARACTERISTICS

(V_{DD} = V_{LOGIC} = +2.7V to +5.5V, V_{SS} = 0V, GND = 0V, V_{H-} = V_{DD}, V_{L-} = V_{SS}, T_A = T_{MIN} to T_{MAX}. Typical values are at T_A = +25°C, unless otherwise specified.) (Note 1)

PARAMETER	SYMBOL	CONDITIONS	MIN	TYP	MAX	UNITS
End-to-End Resistance	R	Figures 1, 2	7	10	13	kΩ
Maximum Bandwidth	f _{CUTOFF}	From H ₋ to W ₋ , C _{LOAD} = 10pF		100		kHz
Absolute Ratio Tolerance		No load at the output of the wiper, W ₋ = -6dB		±0.25		dB
Tap-to-Tap Tolerance				±0.1		dB
Total Harmonic Distortion Plus Noise	THD+N	V _{DD} = 5V, V _{H-} = (V _{DD} / 2) + 1V _{RMS} , f = 1kHz, tap = -6dB, V _{L-} = V _{DD} / 2, R _L = ∞		0.01		%
		V _{DD} = 3V, V _{SS} = 0V, V _{L-} = 1.5V, V _{H-} = 1.5V + 1V _{RMS} , f = 1kHz, R _L = 10kΩ to (V _{DD} / 2), C _L = 5pF, tap = -6dB		0.23		
Channel-to-Channel Isolation				-100		dB
Interchannel Matching		f = 20Hz to 20kHz, tap = -6dB		±0.5		dB
Mute Attenuation				-90		dB
Power-Supply Rejection Ratio	PSRR			-80		dB
Wiper Resistance	R _W			1000	1700	Ω
Wiper Capacitance	C _W			10		pF
H Terminal Capacitance	C _H			5		pF
L Terminal Capacitance	C _L			7		pF
End-to-End Resistance Temperature Coefficient				50		ppm/°C
Ratiometric Resistance Temperature Coefficient				5		ppm/°C
Output Noise	e _n	20Hz to 20kHz		0.95		μV _{RMS}
PUSHBUTTON CONTACT INPUTS (UP/BAL1, DN/BAL0, MUTE, VOLUP, VOLDN, BAL0, BAL1, MODE)						
Internal Pullup Resistor	R _{PULLUP}		32	50	65	kΩ
Single Pulse-Width Input	t _{1PW}	Figure 5	22.5			ms
Repetitive Input Pulse High Time	t _{HPW}	Figure 5	40			ms
Timeout Period	t _{WS}	Click/pop suppression inactive		32		ms

Stereo Audio Taper Potentiometers with Pushbutton Interface

MAX5456/MAX5457

ELECTRICAL CHARACTERISTICS (continued)

($V_{DD} = V_{LOGIC} = +2.7V$ to $+5.5V$, $V_{SS} = 0V$, $GND = 0V$, $V_{H_} = V_{DD}$, $V_{L_} = V_{SS}$, $T_A = T_{MIN}$ to T_{MAX} . Typical values are at $T_A = +25^\circ C$, unless otherwise specified.) (Note 1)

PARAMETER	SYMBOL	CONDITIONS	MIN	TYP	MAX	UNITS
First Autoincrement Point				1		s
First Autoincrement Rate				4		Hz
Second Autoincrement Point				4		s
Second Autoincrement Rate				16		Hz
DIGITAL INPUTS ($V_{LOGIC} > 4.5V$)						
Input High Voltage	V_{IH}		2.4			V
Input Low Voltage	V_{IL}				0.8	V
Input Leakage Current		Inputs floating			± 1	μA
Input Capacitance				5		pF
DIGITAL INPUTS ($V_{LOGIC} < 4.5V$)						
Input High Voltage	V_{IH}		$0.7 \times V_{LOGIC}$			V
Input Low Voltage	V_{IL}				$0.3 \times V_{LOGIC}$	V
Input Leakage Current		Inputs floating			± 1	μA
Input Capacitance				5		pF
POWER SUPPLIES						
Supply Voltage	V_{DD}		2.7		5.5	V
Negative Power Supply	V_{SS}		-2.7		0	V
Supply-Voltage Difference		$V_{DD} - V_{SS}$			5.5	V
Active Supply Current	I_{DD}	(Note 2)			100	μA
Standby Supply Current	I_{STBY}	$V_{DD} = +5.5V$, $V_{SS} = 0V$, $V_{LOGIC} = 2.7V$ (Note 3)		2	10	μA
		$V_{LOGIC} = V_{DD} = +2.7V$, $V_{SS} = -2.7V$ (Note 3)		0.5	1	
Shutdown Supply Current	I_{SHDN}	(Note 4)			1	μA
Power-Up Time	t_{PU}			10		ms
Logic Standby Voltage	V_{LOGIC}		2.7		V_{DD}	V
Logic Active Supply Current	I_{LOGIC}	(Note 2)			160	μA
Logic Standby Supply Current	$I_{LOGICSTBY}$	(Note 3)		0.5	1	μA
Logic Shutdown Current	$I_{LOGICSHDN}$	(Note 4)			1	μA
DIGITAL OUTPUT, MODE_IND						
Output Low Voltage	V_{OL}	$V_{LOGIC} = 2.7V$, $I_{SINK} = 10mA$			0.4	V
		$V_{LOGIC} = 5.5V$, $I_{SINK} = 10mA$			0.2	
Output Leakage Current				0.1	10	μA
Output Capacitance				3		pF
Maximum Sink Current				150		mA

Note 1: Parameters are 100% production tested at $+85^\circ C$ and limits through temperature are guaranteed by design.

Note 2: Supply current measured with the supply on and a button pushed.

Note 3: Supply current measured with the power on, no button pushed, and the wiper position fixed.

Note 4: This is the measured current with SHDN low and MODE_IND unconnected.

Stereo Audio Taper Potentiometers with Pushbutton Interface

MAX5456/MAX5457

Typical Operating Characteristics

($V_{DD} = V_{LOGIC} = +2.7V$ to $+5.5V$, $V_{SS} = 0V$, $GND = 0V$, $V_{HL} = V_{DD}$, $V_{L} = V_{SS}$, $T_A = T_{MIN}$ to T_{MAX} . Typical values are at $T_A = +25^\circ C$, unless otherwise specified.)

WIPER RESISTANCE vs. WIPER VOLTAGE

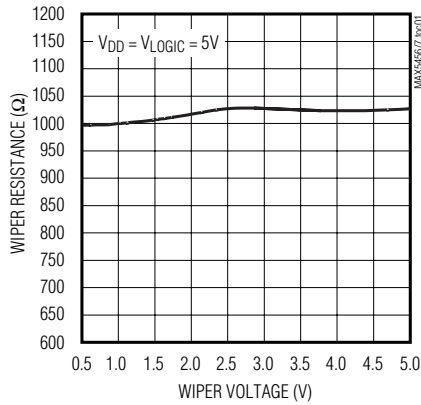

ATTENUATION vs. TAP POSITION

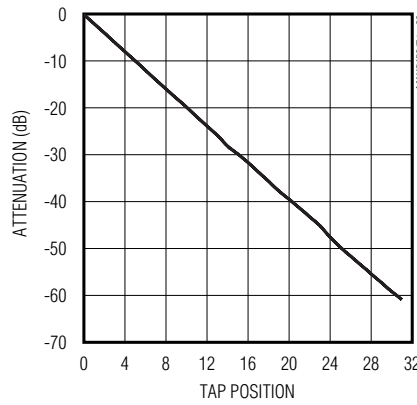

END-TO-END RESISTANCE % CHANGE vs. TEMPERATURE

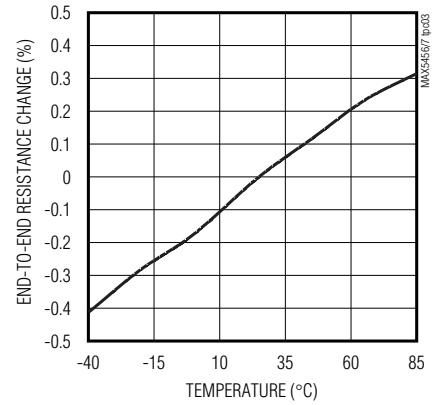

ACTIVE SUPPLY CURRENT vs. TEMPERATURE

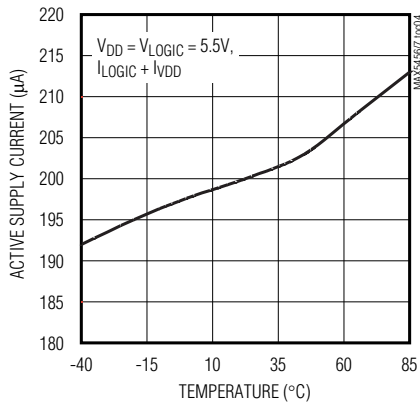

WIPER SWITCHING TRANSIENT (TIMING OUT)

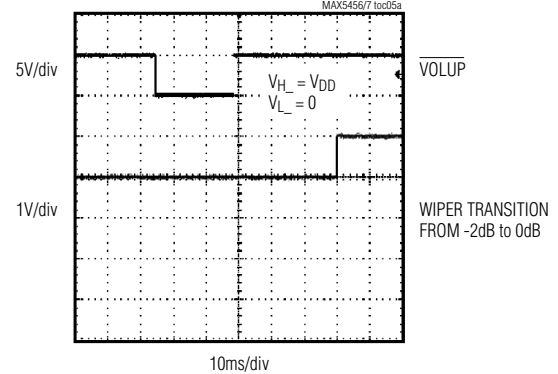

WIPER SWITCHING TRANSIENT (SUPPRESSION CIRCUIT ACTIVE)

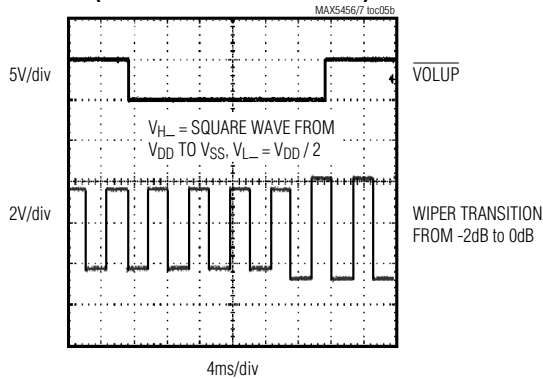

LOGIC SUPPLY CURRENT vs. LOGIC SUPPLY VOLTAGE

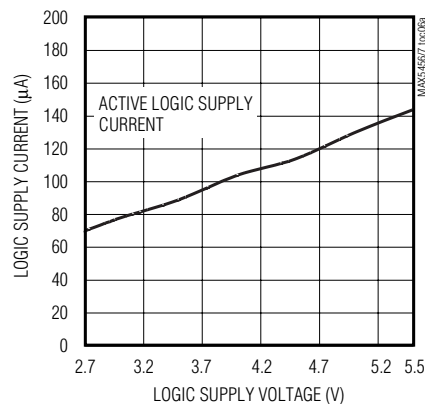

Stereo Audio Taper Potentiometers with Pushbutton Interface

MAX5456/MAX5457

Typical Operating Characteristics (continued)

($V_{DD} = V_{LOGIC} = +2.7V$ to $+5.5V$, $V_{SS} = 0V$, $GND = 0V$, $V_{HL} = V_{DD}$, $V_{L} = V_{SS}$, $T_A = T_{MIN}$ to T_{MAX} . Typical values are at $T_A = +25^\circ C$, unless otherwise specified.)

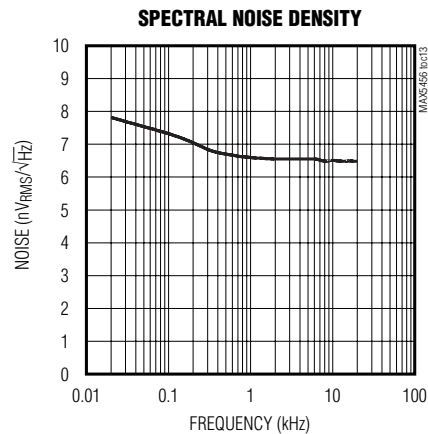
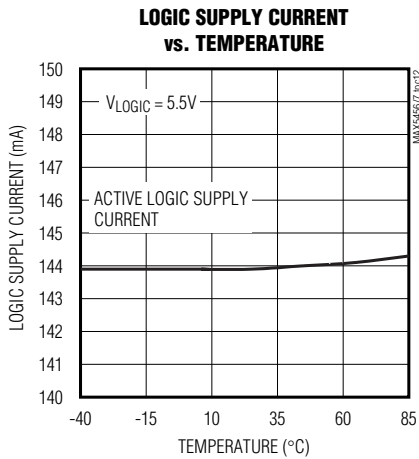
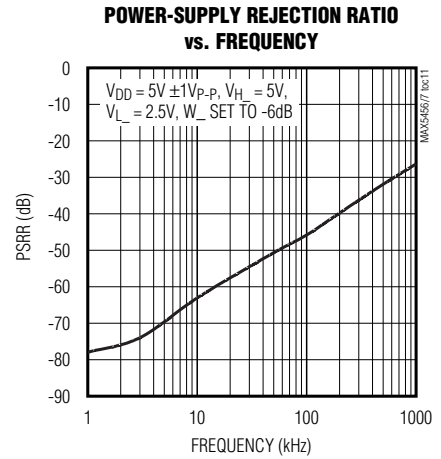
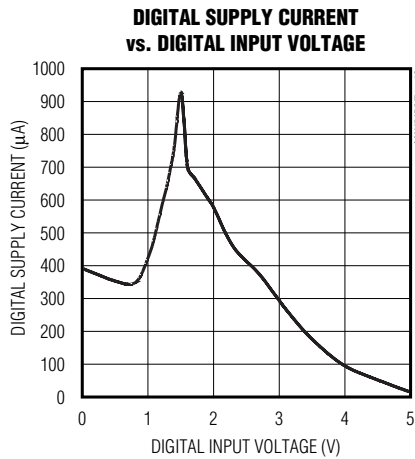
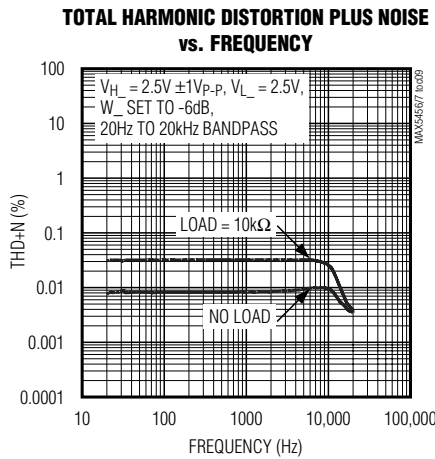
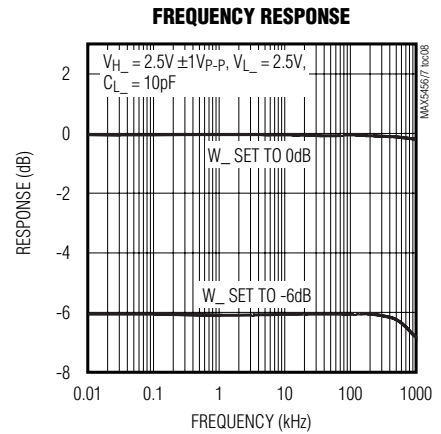
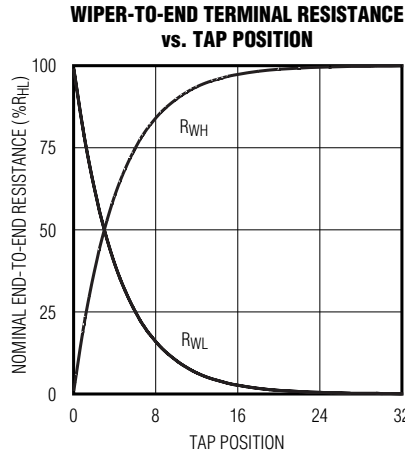
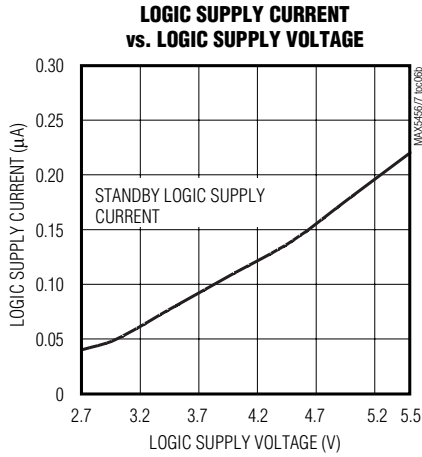

Stereo Audio Taper Potentiometers with Pushbutton Interface

Pin Description

PIN				NAME	FUNCTION
MAX5457		MAX5456			
TQFN	QSOP	TQFN	QSOP		
1	3	—	—	$\overline{\text{MODE}}$	Volume/Balance Control. Each transition from high to low toggles between volume and balance modes. $\overline{\text{MODE}}$ is pulled high internally with a 50k Ω resistor to V_{LOGIC} . On power-up, the MAX5457 is in volume-control mode.
2	4	—	—	MODE_IND	Volume-Control/Balance-Control Mode Indicator Open-Drain Output. Connect to an LED through a resistor to V_{LOGIC} . When the LED is on, the MAX5457 is in balance-control mode. When the LED is off, the MAX5457 is in volume-control mode. See the <i>Mode Indicator</i> , <i>MODE_IND</i> section for more detail.
3	5	3	5	H0	Potentiometer 0 High Terminal. H0 and L0 terminals can be reversed.
4	6	4	6	L0	Potentiometer 0 Low Terminal. L0 and H0 terminals can be reversed.
5	7	5	7	W0	Potentiometer 0 Wiper Terminal
6	8	6	8	$\overline{\text{SHDN}}$	Active-Low Shutdown Input. In shutdown mode, the MAX5456/MAX5457 store the last wiper settings. The wipers move to the L end of the resistor string, and the H end of the resistor string disconnects from the signal input. Terminating shutdown mode restores the wipers to their previous settings.
7	9	7	9	$\overline{\text{MUTE}}$	Mute Input. When $\overline{\text{MUTE}}$ is low, the wiper goes to the highest attenuation setting (see Table 1). $\overline{\text{MUTE}}$ is internally pulled up with 50k Ω to V_{LOGIC} .
8	10	8	10	W1	Potentiometer 1 Wiper Terminal
9	11	9	11	L1	Potentiometer 1 Low Terminal. L1 and H1 terminals can be reversed.
10	12	10	12	H1	Potentiometer 1 High Terminal. H1 and L1 terminals can be reversed.
11	13	11	13	VSS	Negative Power Supply. Bypass with 0.1 μF to ground.
12	14	12	14	GND	Ground
13	15	13	15	V_{LOGIC}	Digital Logic Power Supply. Bypass with 0.1 μF to ground.
14	16	14	16	V_{DD}	Analog Power Supply. Bypass with 0.1 μF to ground.
15	1	—	—	$\overline{\text{DN/BAL0}}$	Downward Volume/Channel 0 Balance-Control Input. In volume mode, pressing $\overline{\text{DN/BAL0}}$ moves both wipers towards the L terminals. In balance mode, pressing $\overline{\text{DN/BAL0}}$ moves the balance towards channel 0. $\overline{\text{DN/BAL0}}$ is internally pulled up with 50k Ω to V_{LOGIC} .
16	2	—	—	$\overline{\text{UP/BAL1}}$	Upward Volume/Channel 1 Balance-Control Input. In volume mode, pressing $\overline{\text{UP/BAL1}}$ moves both wipers towards the H terminals. In balance mode, pressing $\overline{\text{UP/BAL1}}$ moves the balance towards channel 1. $\overline{\text{UP/BAL1}}$ is internally pulled up with 50k Ω to V_{LOGIC} .
—	—	1	3	$\overline{\text{BAL1}}$	Channel 1 Balance-Control Input. Pressing $\overline{\text{BAL1}}$ moves the balance towards channel 1. $\overline{\text{BAL1}}$ is internally pulled up with 50k Ω to V_{LOGIC} .
—	—	2	4	$\overline{\text{BAL0}}$	Channel 0 Balance-Control Input. Pressing $\overline{\text{BAL0}}$ moves the balance towards channel 0. $\overline{\text{BAL0}}$ is internally pulled up with 50k Ω to V_{LOGIC} .
—	—	15	1	$\overline{\text{VOLDN}}$	Downward Volume-Control Input. Pressing $\overline{\text{VOLDN}}$ moves both wipers towards the L terminals. $\overline{\text{VOLDN}}$ is internally pulled up with 50k Ω to V_{LOGIC} .
—	—	16	2	$\overline{\text{VOLUP}}$	Upward Volume-Control Input. Pressing $\overline{\text{VOLUP}}$ moves both wipers towards the H terminals. $\overline{\text{VOLUP}}$ is internally pulled up with 50k Ω to V_{LOGIC} .

Stereo Audio Taper Potentiometers with Pushbutton Interface

Detailed Description

The MAX5456/MAX5457 dual, logarithmic taper digital potentiometers feature a simple pushbutton interface that controls volume and balance in audio applications. Each potentiometer has 32 tap points and replaces mechanical potentiometers (see the *Functional Diagrams*).

Up and Down Interface

The MAX5456/MAX5457 interface with momentary contact SPST switches. All switch inputs are internally debounced and pulled up to V_{LOGIC} through $50\text{k}\Omega$ resistors. The wiper setting advances once per button press up to 1s. Maxim's SmartWiper control circuitry allows the wiper to advance at a rate of 4Hz when an input is held low from 1s up to 4s, and at a rate of 16Hz if the contact is maintained for greater than 4s (see Table 2). The SmartWiper control eliminates the need for a microcomputer to increase the wiper transition rate.

The MAX5456 features independent control inputs for volume and balance control while the MAX5457 $\overline{\text{MODE}}$ input toggles between volume and balance control. Each transition of $\overline{\text{MODE}}$ from high to low toggles the MAX5457 between volume-control and balance-control modes. $\overline{\text{MODE}}$ is internally pulled high with a $50\text{k}\Omega$ resistor to V_{LOGIC} .

Volume Control

In volume-control mode, the MAX5456/MAX5457s' wipers move simultaneously, maintaining the balance separation between each wiper (Figure 3a).

When either wiper reaches the maximum tap position (position closest to H_{L}), further commands to increase the volume are ignored. Balance separation is maintained in the maximum volume configuration (Figure 3b).

When either wiper reaches the minimum tap position (position closest to L_{L}), further commands to decrease the volume adjust the other wiper until it also reaches the minimum tap position (Figure 3c).

Increasing the volume from this minimum position restores the original balance separation of the wipers (Figure 3d).

When both wipers are in the 31st tap position (-62dB attenuation), further commands to $\overline{\text{VOLDN}}$ place the wipers in the mute position (see Table 1). $\overline{\text{VOLUP}}$ or $\overline{\text{MUTE}}$ pulses return wipers to position 31.

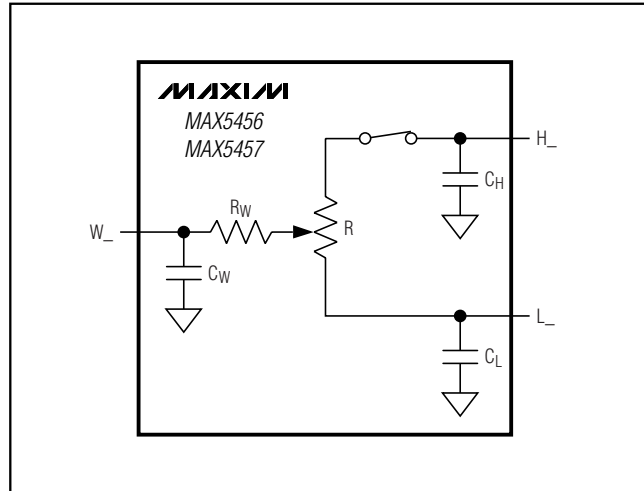

Figure 1. Potentiometer Model (Active)

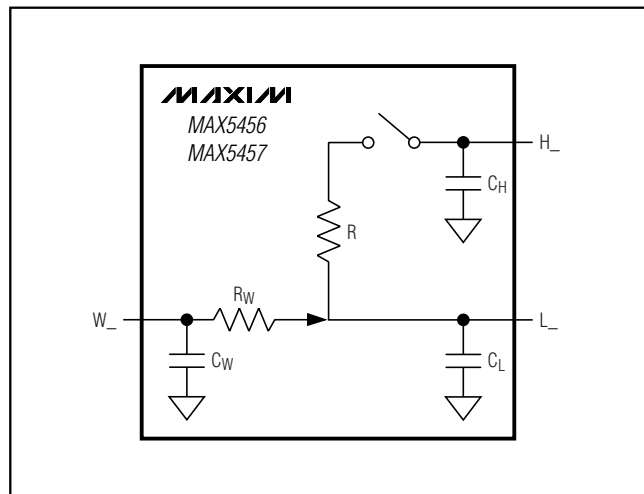

Figure 2. Potentiometer Model (Shutdown)

MAX5456/MAX5457

Stereo Audio Taper Potentiometers with Pushbutton Interface

MAX5456/MAX5457

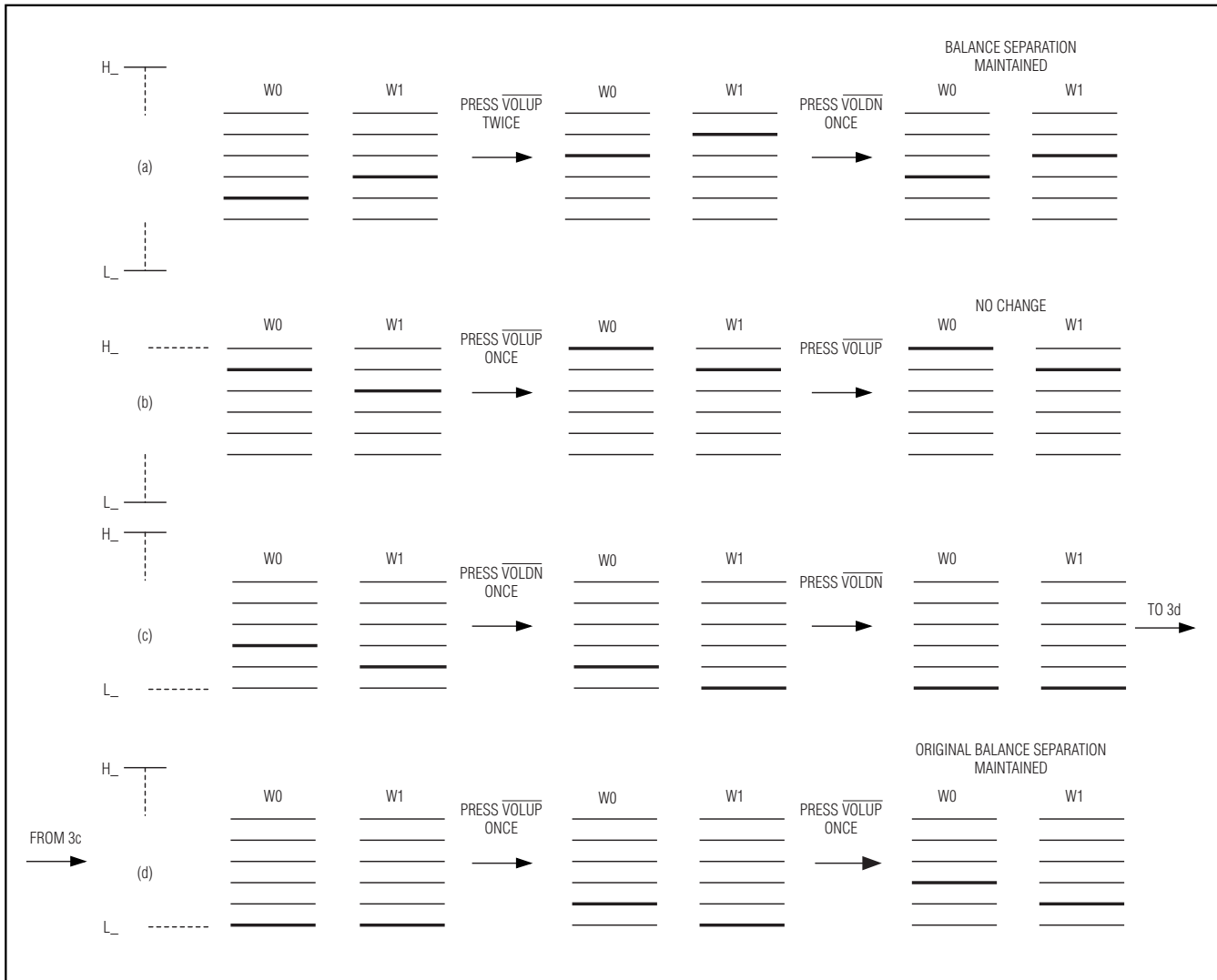

Figure 3. Volume-Control Operation

Table 1. Wiper Position and Attenuation

POSITION	ATTENUATION (dB)
0	0
1	2
2	4
⋮	⋮
6 (POR)	12
⋮	⋮
30	60
31	62
32 (mute)	>90

Stereo Audio Taper Potentiometers with Pushbutton Interface

Balance Control

In balance-control mode, the MAX5456/MAX5457 adjust the balance between channel 0 and channel 1 while maintaining the set volume. For example, if the volume of channel 0 equals the volume of channel 1, forcing the balance towards channel 1 increases the attenuation of channel 0 (Figure 4a). If channel 1 is at a higher attenuation than channel 0, adjusting the balance to channel 1 moves channel 1's wiper up to the same wiper position as channel 0 before attenuating channel 0 (Figure 4b).

To control the wiper quickly with a logic signal, maintain pulses at least 22.5ms wide and separated by at least 40ms.

Table 2. Wiper Action vs. Pushbutton Contact Duration

CONTACT DURATION	WIPER ACTION
$t < 22.5\text{ms}$	No motion (debouncing).
$22.5\text{ms} < t \leq 1\text{s}$	Wiper changes position once.
$1\text{s} < t \leq 4\text{s}$	Wiper changes position at a rate of 4Hz.
$t > 4\text{s}$	Wiper changes position at a rate of 16Hz.

MAX5456/MAX5457

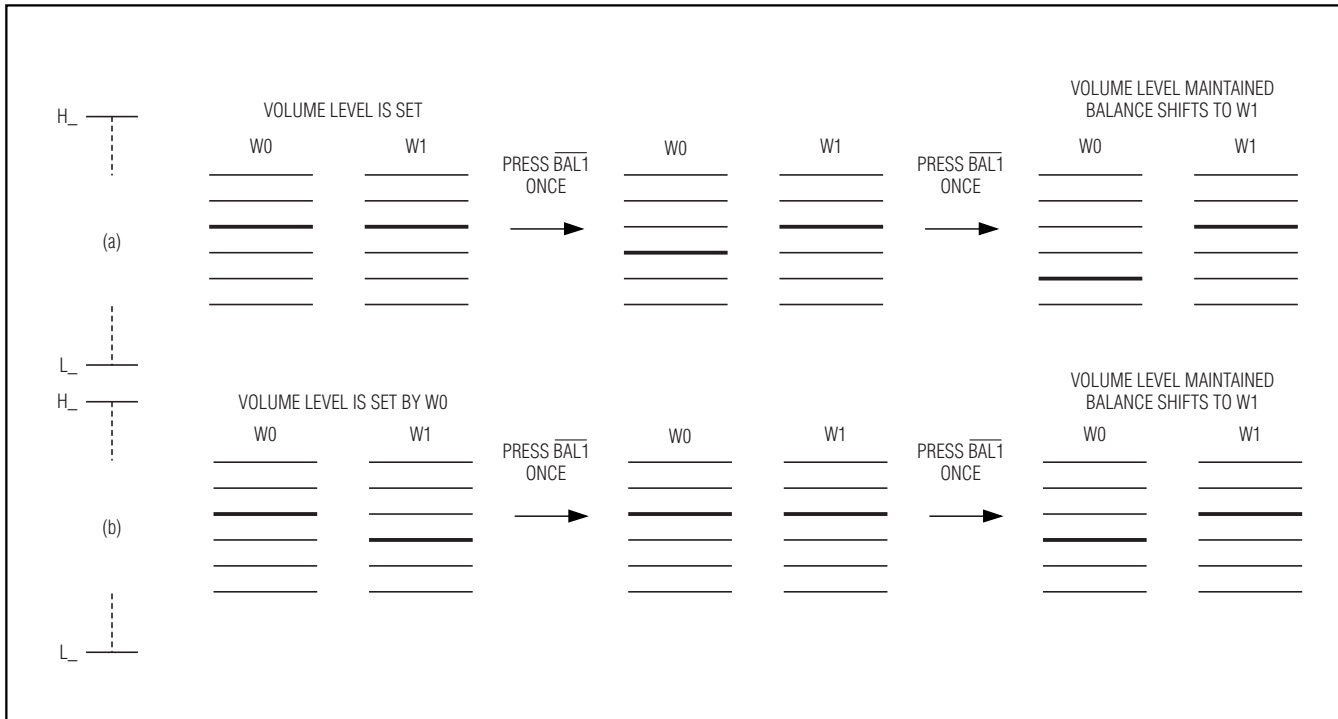

Figure 4. Balance-Control Operation

Stereo Audio Taper Potentiometers with Pushbutton Interface

MAX5456/MAX5457

Click/Pop Suppression

The click/pop suppression feature reduces the audible noise (clicks and pops) that result from wiper transitions. The MAX5456/MAX5457 minimize this noise by allowing the wiper position changes only when $V_{H_} = V_{L_}$. Thus, the wiper changes position only when the voltage at L_{-} is the same as the voltage at the corresponding H_{-} . Each wiper has its own suppression and timeout circuitry (see Figure 5a). The MAX5456/MAX5457 change wiper position after 32ms or when $V_{H_} = V_{L_}$, whichever occurs first (see Figure 5b).

The suppression circuitry monitors left and right channels separately. In volume-control mode, when the first wiper changes position, the second wiper has 32ms to change or it will be forced to change.

Power-On Reset

The power-on comparators monitor $V_{DD} - V_{SS}$ and $V_{LOGIC} - GND$. A power-on reset is initiated when either of the supplies is brought back to normal operating voltage. The power-on-reset feature sets both wipers to -12dB. Power-on reset places the MAX5457 in volume-control mode.

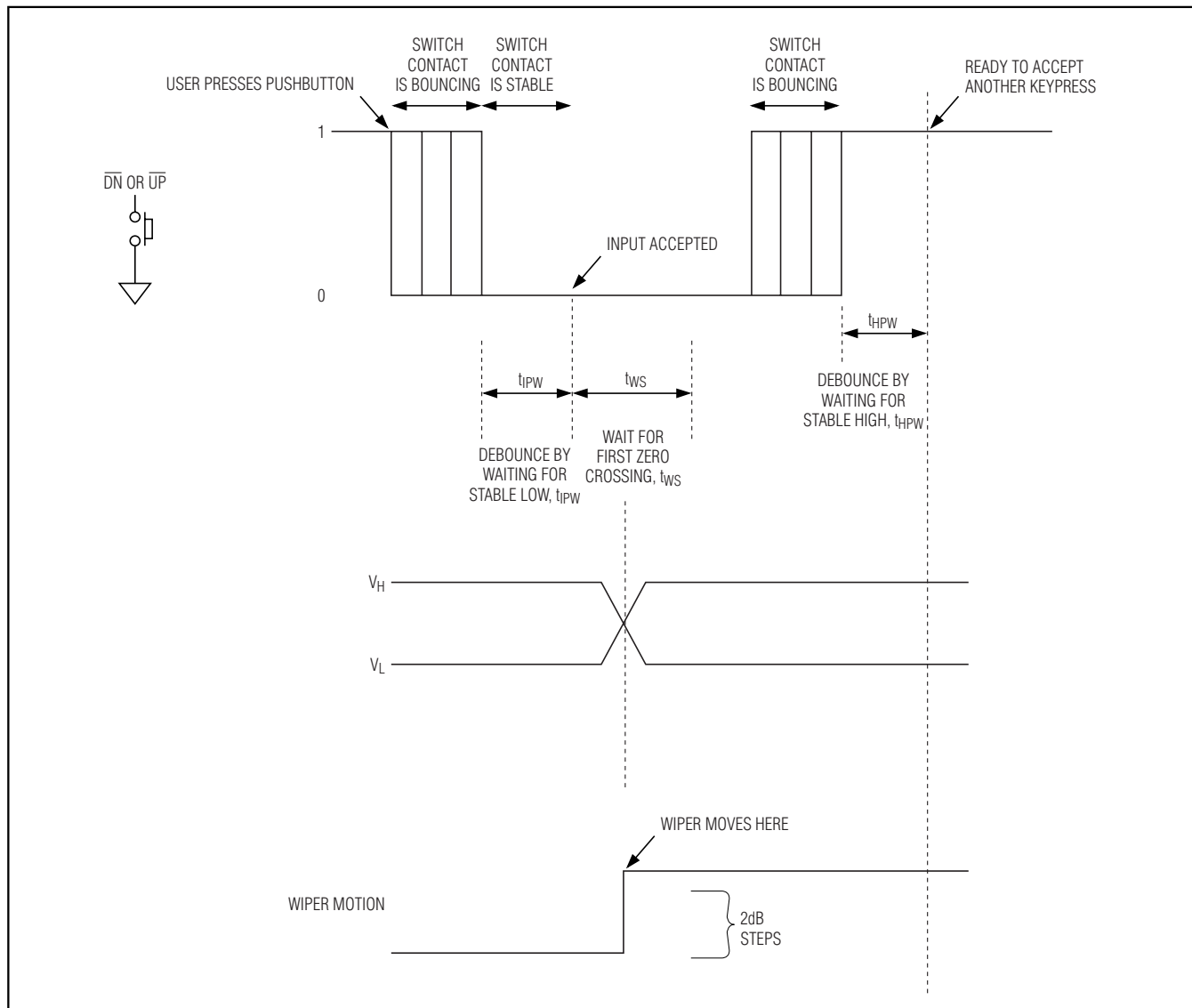

Figure 5a. Wiper Transition Timing Diagram

Stereo Audio Taper Potentiometers with Pushbutton Interface

Shutdown, \overline{SHDN}

Upon entering shutdown mode, the MAX5456/MAX5457 store the last wiper settings. The wipers move to the L_ end of the resistor string, and the H_ end of the resistor string disconnects from the signal input. Terminating shutdown mode restores the wipers to their previous settings (see Figure 2). Shutdown does not affect the state of MODE_IND.

Mute Function, \overline{MUTE}

The MAX5456/MAX5457 feature a mute function. Successive pulses on MUTE toggle its setting. Activating the mute

function forces both wipers to maximum attenuation (-90dB typ). Deactivating the mute function returns the wipers to their previous settings. Pressing VOLUP also deactivates mute, setting the wipers to their previous positions. MUTE is internally pulled high with a 50k Ω resistor to VLOGIC. When both wipers are in the 31st tap position (-62dB attenuation), further commands to VOLDN place the wipers in the mute position (see Table 1). VOLUP or MUTE pulses return the wipers to position 31.

MAX5456/MAX5457

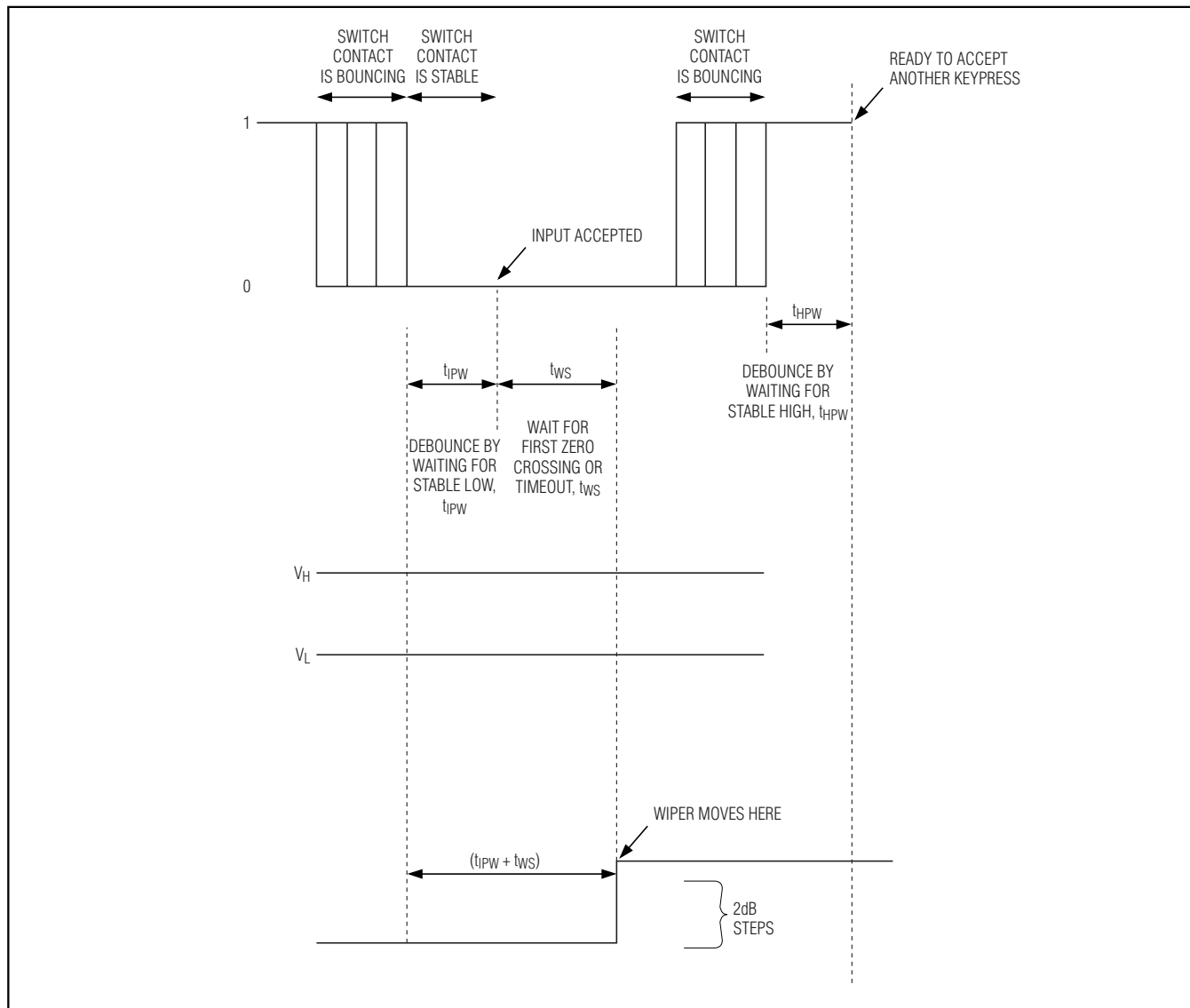

Figure 5b. Wiper Transition Timing Diagram

Stereo Audio Taper Potentiometers with Pushbutton Interface

MAX5456/MAX5457

Mode Control, $\overline{\text{MODE}}$

The MAX5457 $\overline{\text{MODE}}$ input toggles between volume- and balance-control modes. Force $\overline{\text{MODE}}$ low to toggle between volume-control and balance-control modes. For example, driving $\overline{\text{MODE}}$ low once while in volume-control mode, switches the MAX5457 to balance-control mode. Driving mode low once again, switches the MAX5457 back to volume-control mode. $\overline{\text{MODE}}$ is internally pulled high with a 50k Ω resistor to V_{LOGIC} . The MAX5457 powers up in volume-control mode.

Mode Indicator, MODE_IND

MODE_IND is the volume-control and balance-control mode indicator with an open-drain output. Connect MODE_IND to an LED through a pullup resistor to V_{LOGIC} . When the LED is on, the MAX5457 is in balance-control mode. When the LED is off, the MAX5457 is in volume-control mode. See the *Mode Control, $\overline{\text{MODE}}$* section for more detail on switching between modes. Shutdown does not affect the state of MODE_IND .

Multiple Button Pushes

The MAX5456/MAX5457 do not respond to simultaneous button pushes. Pushing more than one button at the same time stops the wipers in their present states. Only a single button push configures the device. Additionally, a 40ms blocking period affects all other inputs when releasing any input forced low. The MAX5456/MAX5457 do not respond to any logic input until the blocking period ends. If multiple wiper-control buttons are pressed, all wiper-control connections must be released before the part will respond to further commands.

Applications Information

Stereo Volume/Balance Control

Figure 6 shows a volume/balance application using the MAX5457. The op amp is connected in a follower (non-inverting gain) configuration to isolate the potentiometer's wiper impedance from the load and provide drive capability. Connect the W_{-} of the MAX5457 to the positive input of a noninverting gain amp. The pushbutton potentiometers attenuate the input signals. Use the $\overline{\text{MODE}}$ input to switch between volume-control and balance-control modes.

Stereo Audio Taper Potentiometers with Pushbutton Interface

MAX5456/MAX5457

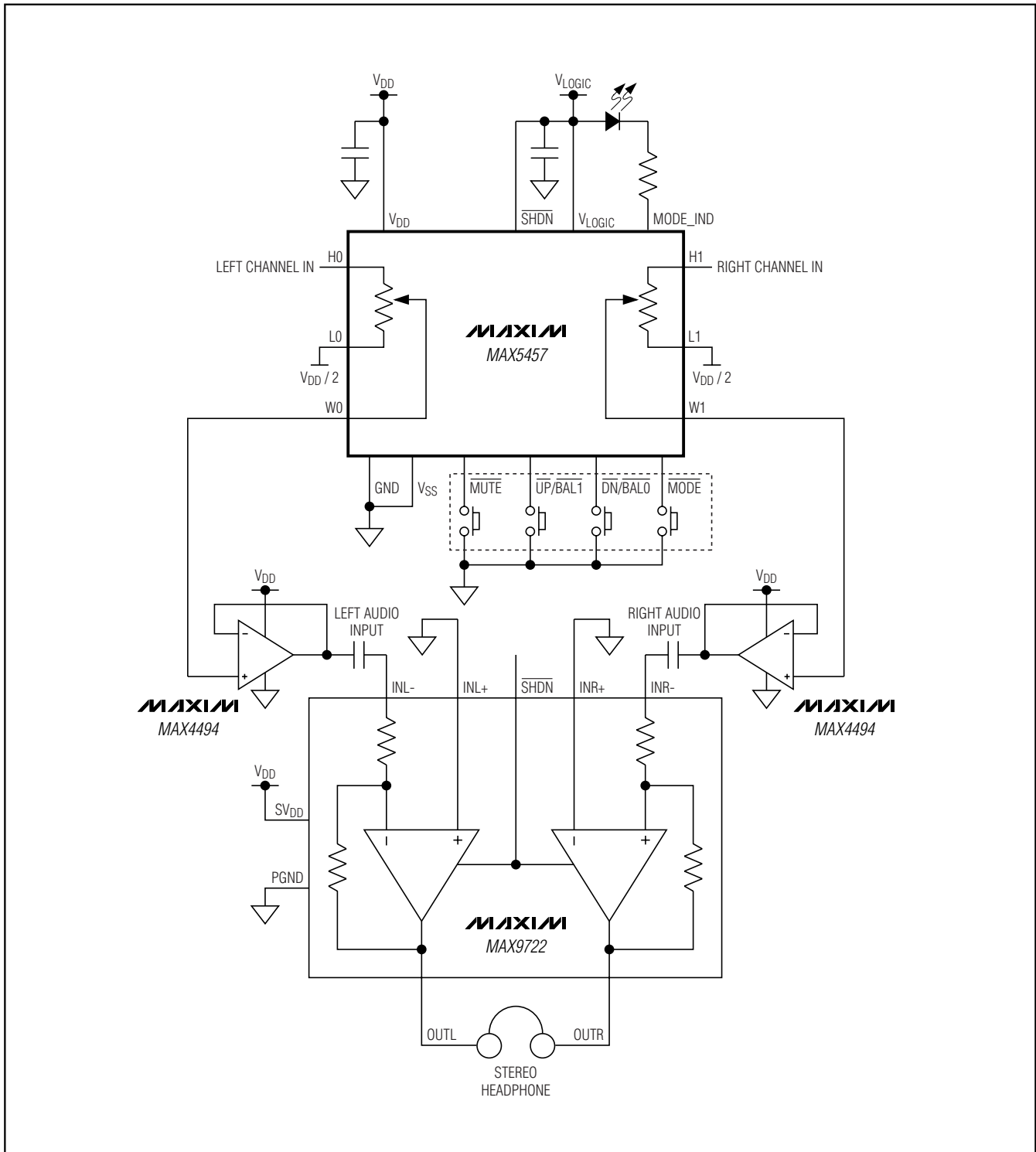

Figure 6. Volume/Balance Control

Stereo Audio Taper Potentiometers with Pushbutton Interface

MAX5456/MAX5457

Selector Guide

PART	INTERFACE	PKG. CODE
MAX5456EEE	4-Button	E16-1
MAX5456ETE*	4-Button	T1644-4
MAX5457EEE	3-Button	E16-1
MAX5457ETE*	3-Button	T1644-4

*Future product—contact factory for availability.

Chip Information

TRANSISTOR COUNT: 15,395
PROCESS: CMOS

Pin Configurations (continued)

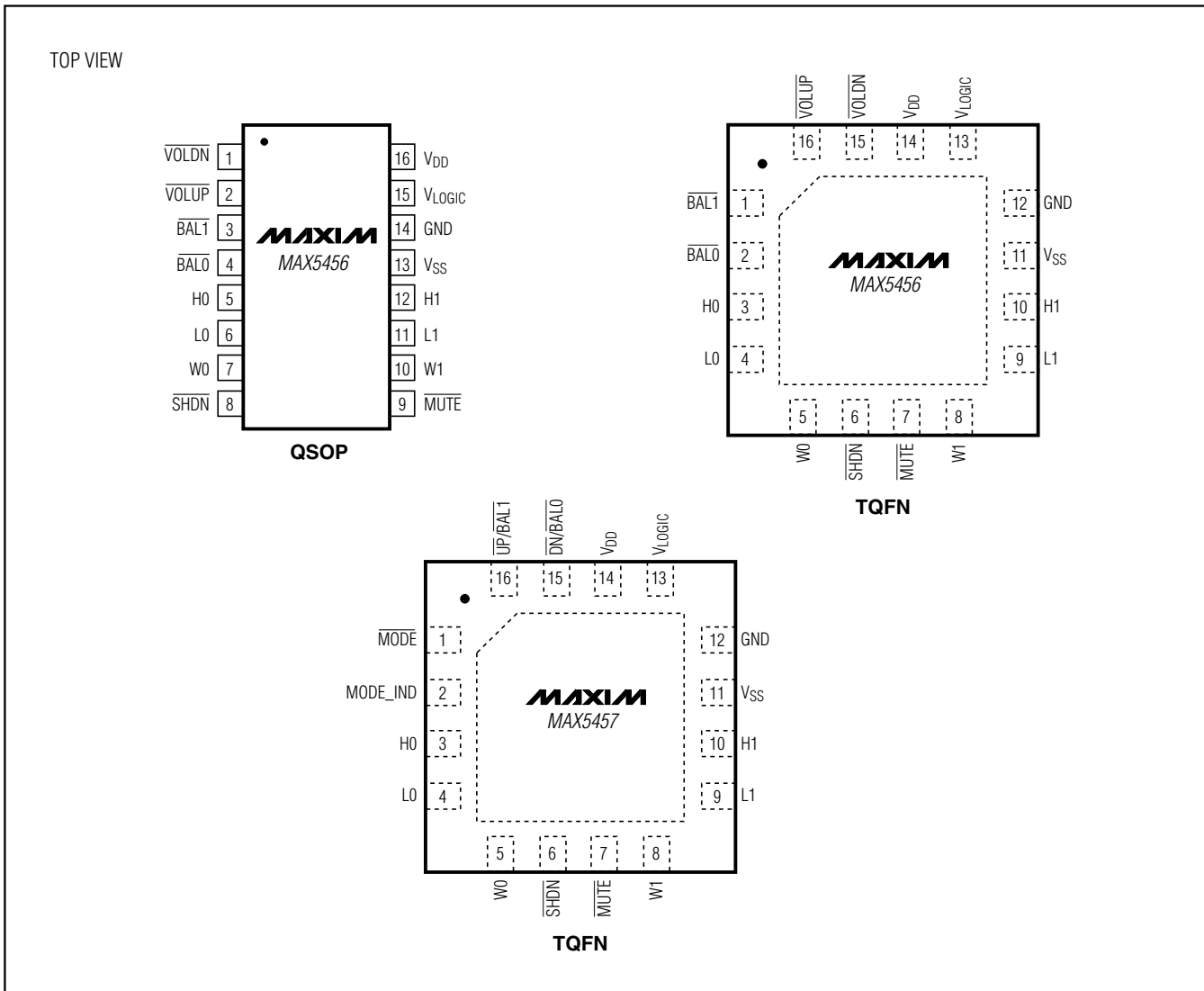

Stereo Audio Taper Potentiometers with Pushbutton Interface

Typical Application Circuit (Single Supply)

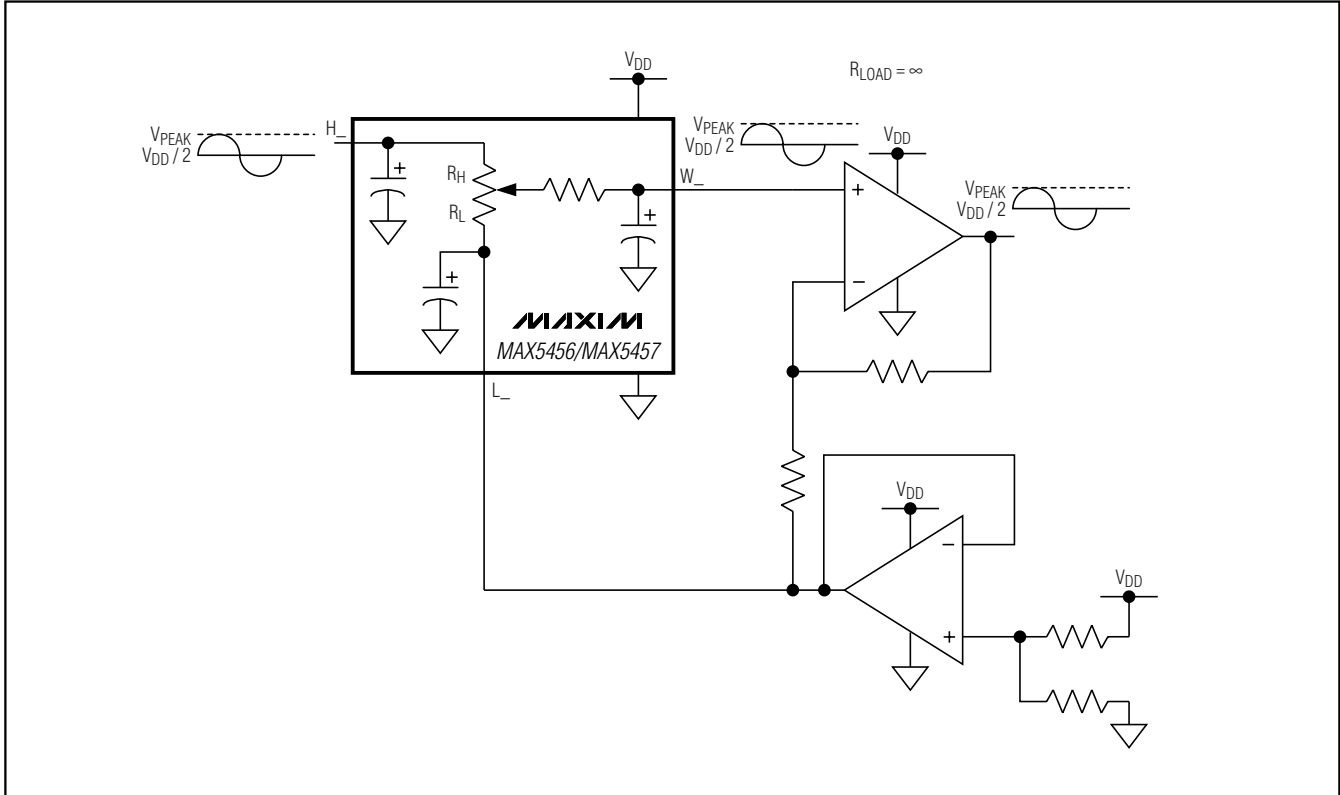

MAX5456/MAX5457

Typical Application Circuit (Dual Supplies)

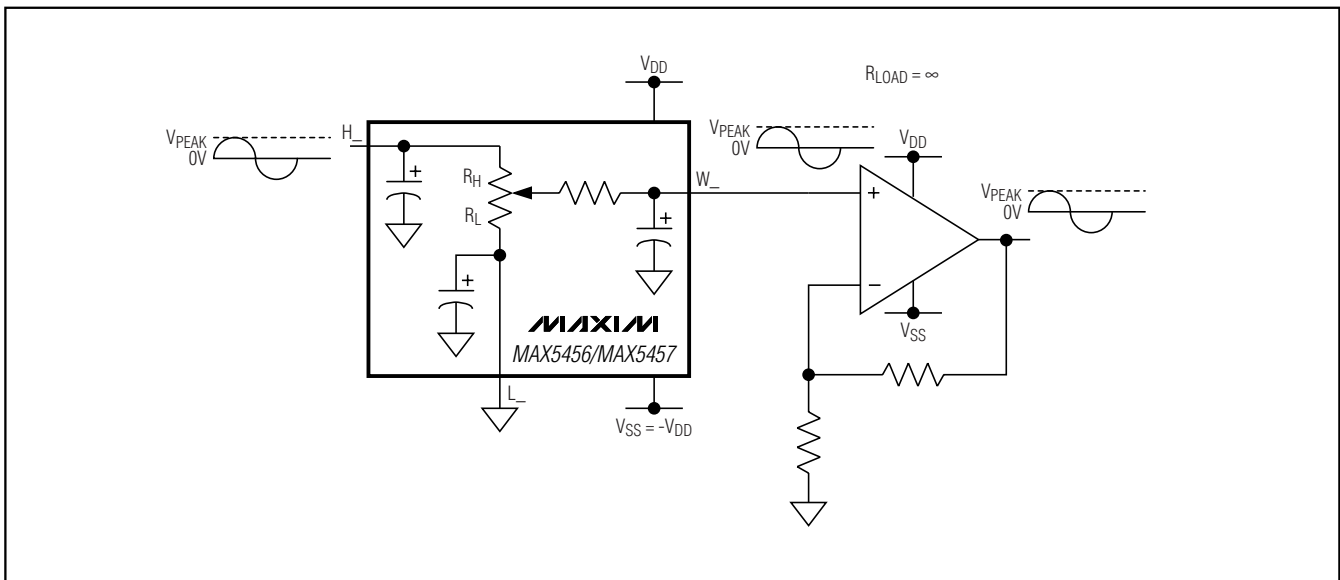

Stereo Audio Taper Potentiometers with Pushbutton Interface

MAX5456/MAX5457

Functional Diagrams

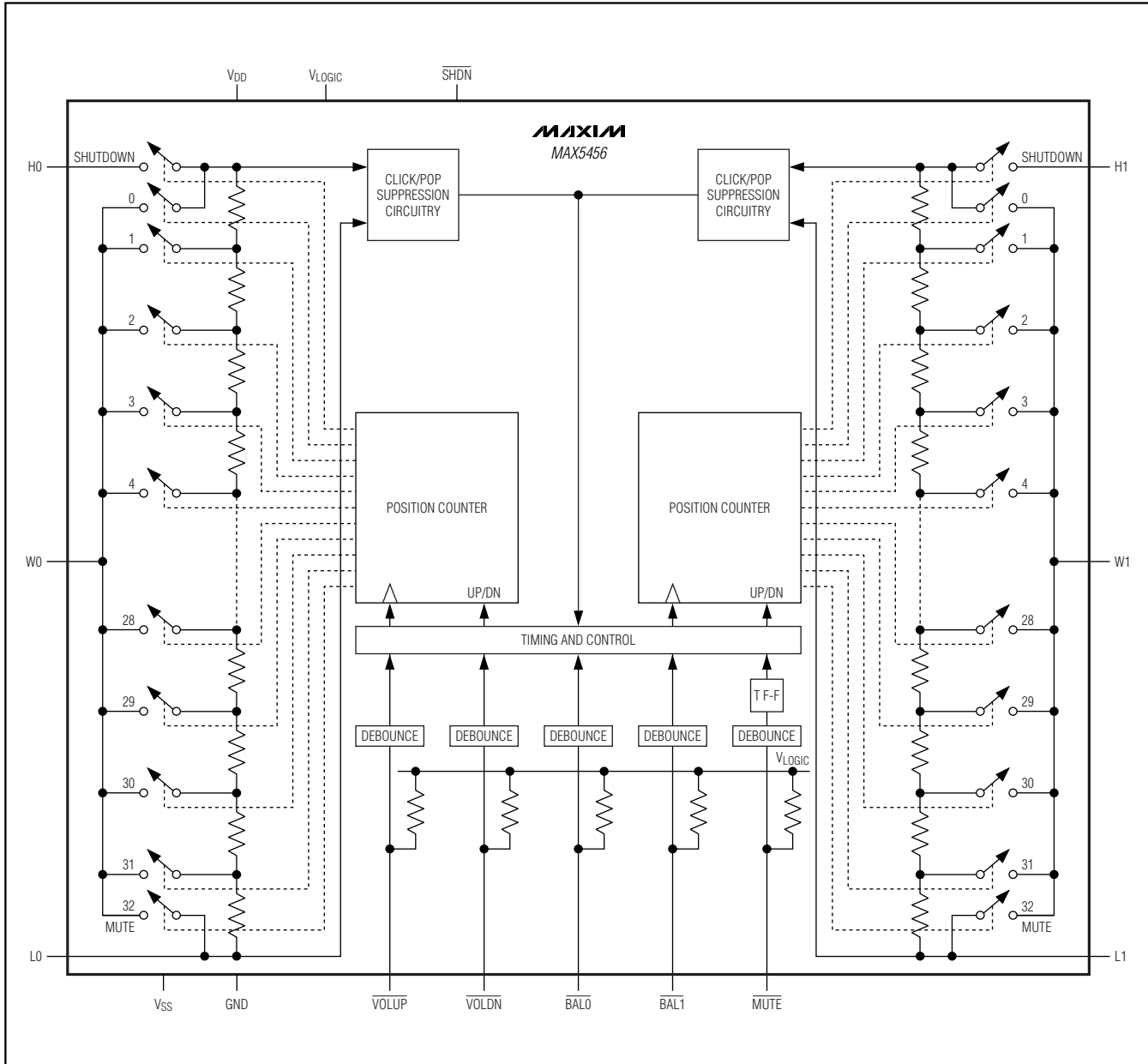

Stereo Audio Taper Potentiometers with Pushbutton Interface

Functional Diagrams (continued)

MAX5456/MAX5457

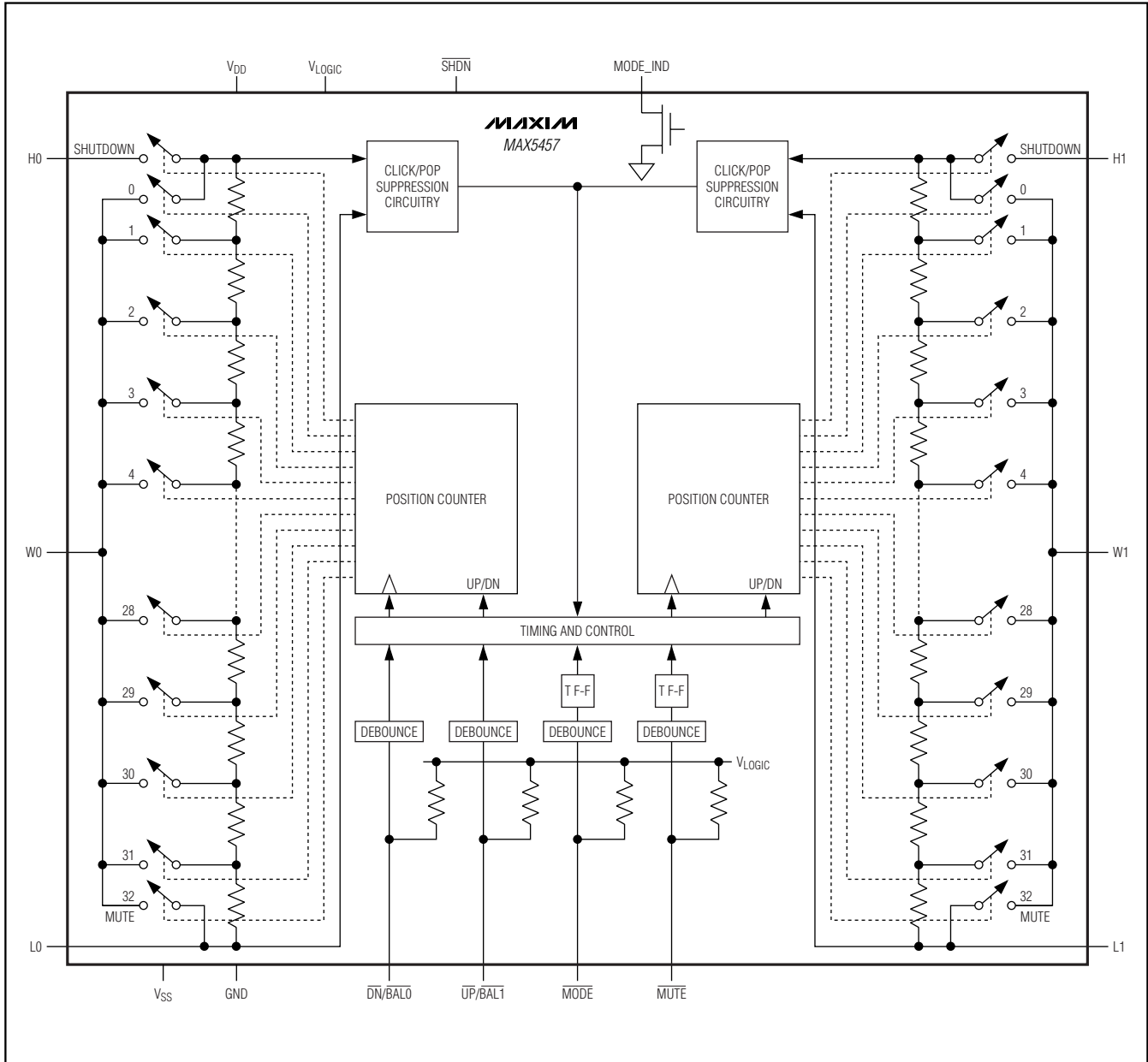

Stereo Audio Taper Potentiometers with Pushbutton Interface

MAX5456/MAX5457

Package Information

(The package drawing(s) in this data sheet may not reflect the most current specifications. For the latest package outline information, go to www.maxim-ic.com/packages.)

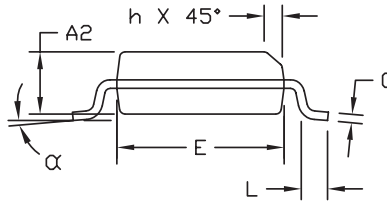
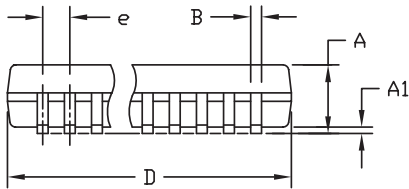
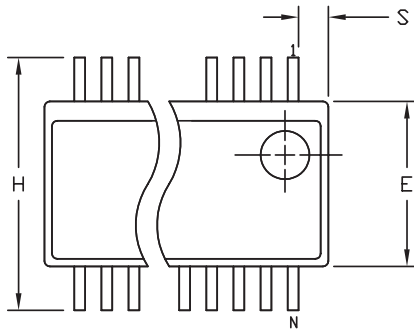

DIM	INCHES		MILLIMETERS	
	MIN	MAX	MIN	MAX
A	.061	.068	1.55	1.73
A1	.004	.0098	0.102	0.249
A2	.055	.061	1.40	1.55
B	.008	.012	0.20	0.30
C	.0075	.0098	0.191	0.249
D	SEE VARIATIONS			
E	.150	.157	3.81	3.99
e	.025 BSC		0.635 BSC	
H	.230	.244	5.84	6.20
h	.010	.016	0.25	0.41
L	.016	.035	0.41	0.89
N	SEE VARIATIONS			
α	0°	8°	0°	8°

VARIATIONS:

DIM	INCHES		MILLIMETERS		N
	MIN.	MAX.	MIN.	MAX.	
D	.189	.196	4.80	4.98	16 AB
S	.0020	.0070	0.05	0.18	
D	.337	.344	8.56	8.74	20 AD
S	.0500	.0550	1.270	1.397	
D	.337	.344	8.56	8.74	24 AE
S	.0250	.0300	0.635	0.762	
D	.386	.393	9.80	9.98	28 AF
S	.0250	.0300	0.635	0.762	

NOTES:

- 1). D & E DO NOT INCLUDE MOLD FLASH OR PROTRUSIONS.
- 2). MOLD FLASH OR PROTRUSIONS NOT TO EXCEED .006" PER SIDE.
- 3). CONTROLLING DIMENSIONS: INCHES.
- 4). MEETS JEDEC MO137.

DALLAS SEMICONDUCTOR **MAXIM**
 PROPRIETARY INFORMATION
 TITLE:
 PACKAGE OUTLINE, QSOP .150", .025" LEAD PITCH
 APPROVAL: _____ DOCUMENT CONTROL NO. 21-0055 REV. E 1/1

QSOP:EPS

Stereo Audio Taper Potentiometers with Pushbutton Interface

Package Information (continued)

(The package drawing(s) in this data sheet may not reflect the most current specifications. For the latest package outline information, go to www.maxim-ic.com/packages.)

MAX5456/MAX5457

24L QFN THIN.EPS

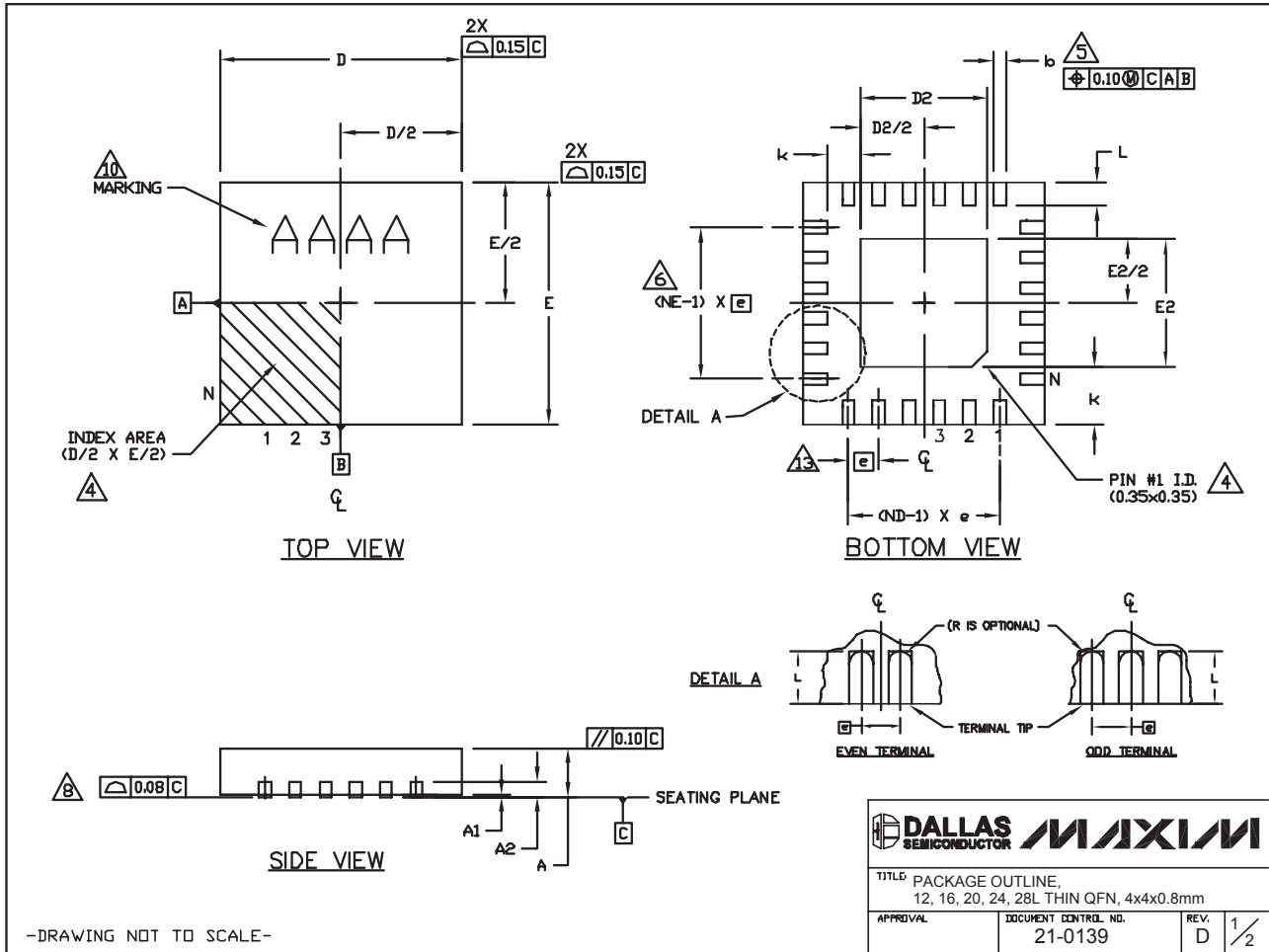

Stereo Audio Taper Potentiometers with Pushbutton Interface

MAX5456/MAX5457

Package Information (continued)

(The package drawing(s) in this data sheet may not reflect the most current specifications. For the latest package outline information, go to www.maxim-ic.com/packages.)

COMMON DIMENSIONS															
PKG	12L 4x4			16L 4x4			20L 4x4			24L 4x4			28L 4x4		
REF.	MIN.	NOM.	MAX.	MIN.	NOM.	MAX.	MIN.	NOM.	MAX.	MIN.	NOM.	MAX.	MIN.	NOM.	MAX.
A	0.70	0.75	0.80	0.70	0.75	0.80	0.70	0.75	0.80	0.70	0.75	0.80	0.70	0.75	0.80
A1	0.0	0.02	0.05	0.0	0.02	0.05	0.0	0.02	0.05	0.0	0.02	0.05	0.0	0.02	0.05
A2	0.20 REF			0.20 REF			0.20 REF			0.20 REF			0.20 REF		
b	0.25	0.30	0.35	0.25	0.30	0.35	0.20	0.25	0.30	0.18	0.23	0.30	0.15	0.20	0.25
D	3.90	4.00	4.10	3.90	4.00	4.10	3.90	4.00	4.10	3.90	4.00	4.10	3.90	4.00	4.10
E	3.90	4.00	4.10	3.90	4.00	4.10	3.90	4.00	4.10	3.90	4.00	4.10	3.90	4.00	4.10
e	0.80 BSC.			0.65 BSC.			0.50 BSC.			0.50 BSC.			0.40 BSC.		
k	0.25	-	-	0.25	-	-	0.25	-	-	0.25	-	-	0.25	-	-
L	0.45	0.55	0.65	0.45	0.55	0.65	0.45	0.55	0.65	0.30	0.40	0.50	0.30	0.40	0.50
N	12			16			20			24			28		
ND	3			4			5			6			7		
NE	3			4			5			6			7		
JeDEC QFN	VGG3			VGGC			WGGD-1			WGGD-2			VGGE		

EXPOSED PAD VARIATIONS							
PKG CODES	D2			E2			DOWN BONDS ALLOWED
	MIN.	NOM.	MAX.	MIN.	NOM.	MAX.	
T1244-2	1.95	2.10	2.25	1.95	2.10	2.25	NO
T1244-3	1.95	2.10	2.25	1.95	2.10	2.25	YES
T1244-4	1.95	2.10	2.25	1.95	2.10	2.25	NO
T1644-2	1.95	2.10	2.25	1.95	2.10	2.25	NO
T1644-3	1.95	2.10	2.25	1.95	2.10	2.25	YES
T1644-4	1.95	2.10	2.25	1.95	2.10	2.25	NO
T2044-1	1.95	2.10	2.25	1.95	2.10	2.25	NO
T2044-2	1.95	2.10	2.25	1.95	2.10	2.25	YES
T2044-3	1.95	2.10	2.25	1.95	2.10	2.25	NO
T2444-1	2.45	2.60	2.63	2.45	2.60	2.63	NO
T2444-2	1.95	2.10	2.25	1.95	2.10	2.25	YES
T2444-3	2.45	2.60	2.63	2.45	2.60	2.63	YES
T2444-4	2.45	2.60	2.63	2.45	2.60	2.63	NO
T2844-1	2.50	2.60	2.70	2.50	2.60	2.70	NO

NOTES:

- DIMENSIONING & TOLERANCING CONFORM TO ASME Y14.5M-1994.
- ALL DIMENSIONS ARE IN MILLIMETERS. ANGLES ARE IN DEGREES.
- N IS THE TOTAL NUMBER OF TERMINALS.
- THE TERMINAL #1 IDENTIFIER AND TERMINAL NUMBERING CONVENTION SHALL CONFORM TO JEDEC 95-1 SPP-012. DETAILS OF TERMINAL #1 IDENTIFIER ARE OPTIONAL, BUT MUST BE LOCATED WITHIN THE ZONE INDICATED. THE TERMINAL #1 IDENTIFIER MAY BE EITHER A MOLD OR MARKED FEATURE.
- DIMENSION b APPLIES TO METALLIZED TERMINAL AND IS MEASURED BETWEEN 0.25 mm AND 0.30 mm FROM TERMINAL TIP.
- ND AND NE REFER TO THE NUMBER OF TERMINALS ON EACH D AND E SIDE RESPECTIVELY.
- DEPOPULATION IS POSSIBLE IN A SYMMETRICAL FASHION.
- COPLANARITY APPLIES TO THE EXPOSED HEAT SINK SLUG AS WELL AS THE TERMINALS.
- DRAWING CONFORMS TO JEDEC MO220, EXCEPT FOR T2444-1, T2444-3, T2444-4 AND T2844-1.
- MARKING IS FOR PACKAGE ORIENTATION REFERENCE ONLY.
- COPLANARITY SHALL NOT EXCEED 0.08mm
- WARPAGE SHALL NOT EXCEED 0.10mm
- LEAD CENTERLINES TO BE AT TRUE POSITION AS DEFINED BY BASIC DIMENSION "e", ±0.05.

-DRAWING NOT TO SCALE-

TITLE PACKAGE OUTLINE, 12, 16, 20, 24, 28L THIN QFN, 4x4x0.8mm		
APPROVAL	DOCUMENT CONTROL NO.	REV. D
	21-0139	2/2

Maxim cannot assume responsibility for use of any circuitry other than circuitry entirely embodied in a Maxim product. No circuit patent licenses are implied. Maxim reserves the right to change the circuitry and specifications without notice at any time.

20 Maxim Integrated Products, 120 San Gabriel Drive, Sunnyvale, CA 94086 408-737-7600