

FEATURES

- 15 WATTS MAXIMUM OUTPUT POWER
- SINGLE OUTPUT UP TO 4A
- SMALL SIZE AND LOW PROFILE : 1.10 x 0.94 x 0.34 INCH
- HIGH EFFICIENCY UP TO 87%
- 4:1 ULTRA WIDE INPUT VOLTAGE RANGE
- FIXED SWITCHING FREQUENCY
- INPUT TO OUTPUT ISOLATION (BASIC INSULATION)
- INDUSTRY STANDARD PIN-OUT FEC15 SERIES COMPATIBLE
- SURFACE-MOUNT OR THROUGH-HOLE
- COST EFFICIENT OPEN FRAME DESIGN
- CE MARK MEETS 2006/95/EC, 93/68/EEC AND 2004/108/EC
- UL60950-1, EN60950-1 AND IEC60950-1 LICENSED
- ISO9001 CERTIFIED MANUFACTURING FACILITIES
- COMPLIANT TO RoHS EU DIRECTIVE 2002/95/EC

APPLICATIONS

Wireless Network
Telecom/Datacom
Industry Control System
Measurement Equipment
Semiconductor Equipment

OPTIONS

Positive logic Remote On/Off, SMD type, Without trim, without On/Off pin

DESCRIPTION

LED15W single output DC/DC converters provide up to 15 watts of output power in an industry standard package and footprint. These units are specifically designed to meet the power needs of low profile. All models feature with 4:1 ultra wide input voltage of 9-36 VDC and 18-75 VDC, comprehensively protected against over-current, over-voltage and input under-voltage protection conditions, and trimmable output voltage.

TECHNICAL SPECIFICATION All specifications are typical at nominal input, full load and 25°C otherwise noted

OUTPUT SPECIFICATIONS		
Output power		15 Watts
Voltage accuracy	Full load and nominal Vin	± 1%
Minimum load		0%
Voltage adjustability (Note 6)		±10%
Line regulation	LL to HL at Full Load	± 0.2%
Load regulation	No Load to Full Load	± 0.2%
Ripple and noise	20MHz bandwidth (Measured with a 1µF M/C and a 10µFT/C)	See table
Temperature coefficient		±0.02% / °C, max.
Transient response recovery time	25% load step change	250µS
Over voltage protection (Voltage clamped)	3.3V output	3.7VDC-5.4VDC
	5V output	5.6VDC-7.0VDC
	12V output	13.8VDC-17.5VDC
	15V output	16.8VDC-20.5VDC
Over load protection	% of FL at nominal input	150%, typ.
Short circuit protection		Hiccup, automatics recovery
GENERAL SPECIFICATIONS		
Efficiency		See table
Isolation voltage	Input to Output (Basic Insulation)	2250VDC, min.
Isolation resistance		10 ⁹ ohms, min.
Isolation capacitance		1500pF, max.
Switching frequency	3.3V,5V	350KHz
	12V,15V	400KHz
Approvals and standard	IEC60950-1, UL60950-1, EN60950-1	
Dimensions	1.10 X 0.94 X 0.34 Inch (27.9 X 23.9 X 8.5 mm)	
Weight	10.5g(0.36oz)	
MTBF (Note 1)	BELLCORE TR-NWT-000332	1.322x10 ⁶ hrs
	MIL-HDBK-217F	5.147x10 ⁵ hrs

INPUT SPECIFICATIONS			
Input voltage range	24V nominal input	9 – 36VDC	
	48V nominal input	18 – 75VDC	
Input surge voltage 100mS max	24V input	50VDC	
	48V input	100VDC	
Input reflected ripple current	Nominal Vin and full load		30mA _{p-p}
Start up time	Nominal Vin and constant resistive load	Power up	30mS, max.
		Remote ON/OFF	30mS, max.
Start-up voltage	24V input	9VDC	
	48V input	18VDC	
Shutdown voltage	24V input	8VDC	
	48V input	16VDC	
Remote ON/OFF (Note 7)			
Positive logic(Optional)	DC-DC ON	Open or 3V < Vr < 15V	
	DC-DC OFF	Short or 0V < Vr < 1.2V	
Negative logic(Standard)	DC-DC ON	Short or 0V < Vr < 1.2V	
	DC-DC OFF	Open or 3V < Vr < 15V	
Input current of remote control pin	Nominal Vin	-0.5mA~1.0mA	
Remote off state input current	Nominal Vin	2.5 mA	
ENVIRONMENTAL SPECIFICATIONS			
Operating ambient temperature	-40°C to +85°C (with derating)		
Storage temperature range	-55°C ~ +125°C		
Thermal shock	MIL-STD-810F		
Vibration	MIL-STD-810F		
Relative humidity	5% to 95% RH		
EMC CHARACTERISTICS			
EMI (Note 8)	EN55022	Class A	
Radiated immunity	EN61000-4-3	10 V/m	Perf. Criteria A
Fast transient (Note 9)	EN61000-4-4	± 2KV	Perf. Criteria A
Surge (Note 9)	EN61000-4-5	± 1KV	Perf. Criteria A
Conducted immunity	EN61000-4-6	3 Vr.m.s	Perf. Criteria A





Model Number	Input Range	Output Voltage	Output Current		Output ⁽⁴⁾ Ripple & Noise	Input Current		Eff ⁽⁴⁾ (%)	Capacitor ⁽⁵⁾ Load max
			Min. Load	Full Load		No Load ⁽³⁾	Full Load ⁽²⁾		
LED15-24S3P3W	9 - 36 VDC	3.3 VDC	0mA	4000mA	100mVp-p	60mA	680mA	85	1000μF
LED15-24S05W	9 - 36 VDC	5 VDC	0mA	3000mA	100mVp-p	70mA	754mA	87	1000μF
LED15-24S12W	9 - 36 VDC	12 VDC	0mA	1300mA	100mVp-p	10mA	793mA	86	330μF
LED15-24S15W	9 - 36 VDC	15 VDC	0mA	1000mA	100mVp-p	10mA	763mA	86	220μF
LED15-48S3P3W	18 - 75 VDC	3.3 VDC	0mA	4000mA	100mVp-p	40mA	340mA	85	1000μF
LED15-48S05W	18 - 75 VDC	5 VDC	0mA	3000mA	100mVp-p	40mA	377mA	87	1000μF
LED15-48S12W	18 - 75 VDC	12 VDC	0mA	1300mA	100mVp-p	10mA	397mA	86	330μF
LED15-48S15W	18 - 75 VDC	15 VDC	0mA	1000mA	100mVp-p	10mA	382mA	86	220μF

Note

- BELLCORE TR-NWT-000332. Case 1: 50% Stress, Temperature at 40°C. MIL-HDBK-217F Notice2 @Ta=25 °C, Full load(Ground, Benign, controlled environment)
 - Maximum value at nominal input voltage and full load.
 - Typical value at nominal input voltage and no load.
 - Typical value at nominal input voltage and full load.
 - Test by minimum Vin and constant resistive load.
 - Trimming allows the user to increase or decrease the output voltage set point of the module. This is accomplished by connecting an external resistor between the TRIM pin and either the +VOUT pin or the -VOUT pin.
 - The ON/OFF control pin voltage is reference to -Vin. The order number please see product standard table.
 - The LED15W meets EN55022 class A and class B only with external components connected before the input pin to the converter.
 - An external input filter capacitor is required if the module has to meet EN61000-4-4, EN61000-4-5.
- The filter capacitor Power Mate suggest: Nippon chemi-con KY series, 220μF/100V, ESR 48mΩ.

DIP TYPE

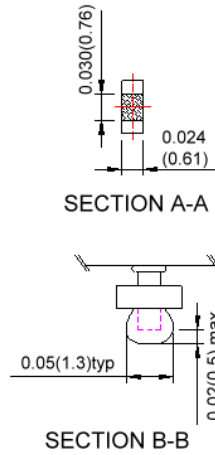
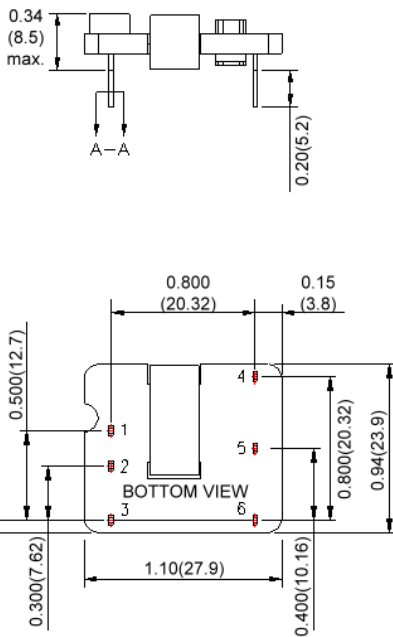

SMD TYPE

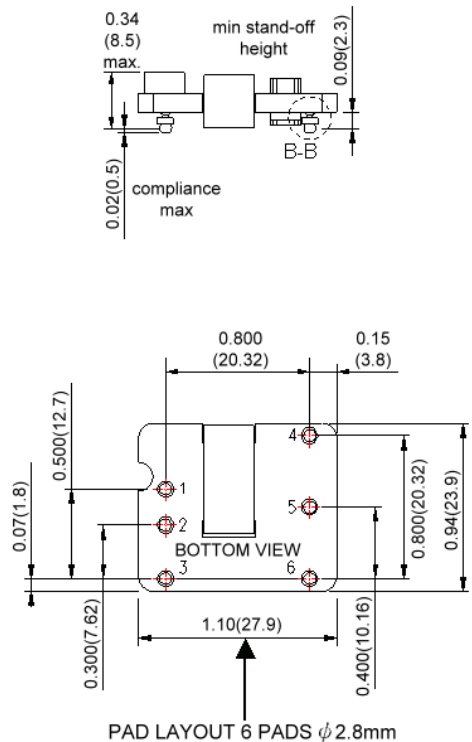

- All dimensions in Inches (mm)
Tolerance: X.XX±0.02 (X.X±0.5)
X.XXX±0.01 (X.XX±0.25)
- Pin pitch tolerance ±0.01(0.25)
- Pin dimension tolerance ±0.004 (0.1)

PIN CONNECTION	
PIN	LED15W SERIES
1	+ INPUT
2	- INPUT
3	ON/OFF
4	+VOUT
5	TRIM
6	-VOUT

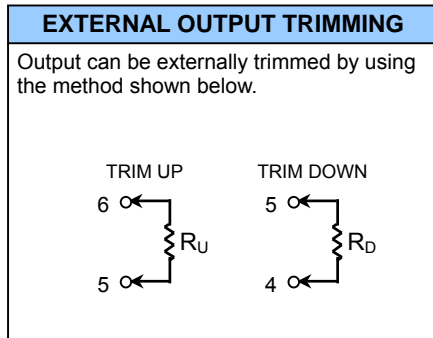

PRODUCT STANDARD TABLE	
Option	Suffix
Negative remote ON/OFF with DIP(Standard)	
Negative remote ON/OFF with SMT	-A
Positive remote ON/OFF with DIP	-B
Positive remote ON/OFF with SMT	-C
DIP type without ON/OFF pin	-D
SMT type without ON/OFF pin	-E
DIP type,negative remote ON/OFF without TRIM pin	-F
SMT type,negative remote ON/OFF without TRIM pin	-G
DIP type without ON/OFF&TRIM pin	-H
SMT type without ON/OFF&TRIM pin	-I
DIP type,positive remote ON/OFF without TRIM pin	-J
SMT type,positive remote ON/OFF without TRIM pin	-K



15 WATTS DC-DC CONVERTER

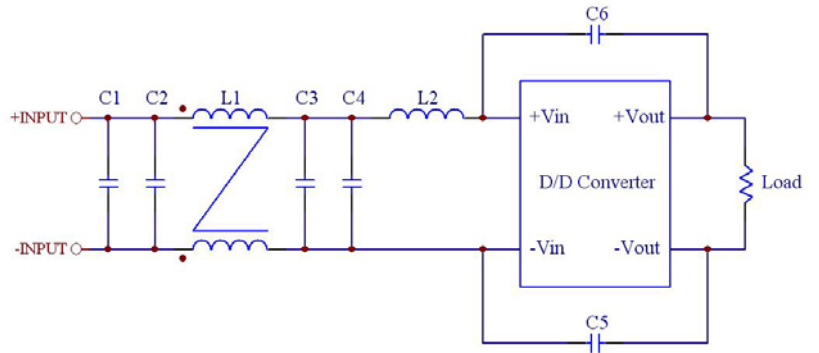
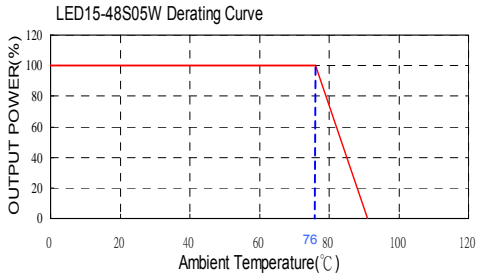

Recommended Filter for EN55022 Class B Compliance

The components used in the above figure, together with the manufacturers' part numbers for these components, are as follows:

	C1	C2 & C3 & C4	C5 & C6	L1	L2
LED15-24xxxW	N/A	6.8μF/50V 1812 MLCC	470pF/3KV 1808 MLCC	145μH Common Choke PMT-051	10μH SMD Inductor PMT-070
LED15-48xxxW	2.2μF/100V 1812 MLCC	2.2μF/100V 1812 MLCC	470pF/3KV 1808 MLCC	325μH Common Choke PMT-050	33μH SMD Inductor PMT-069

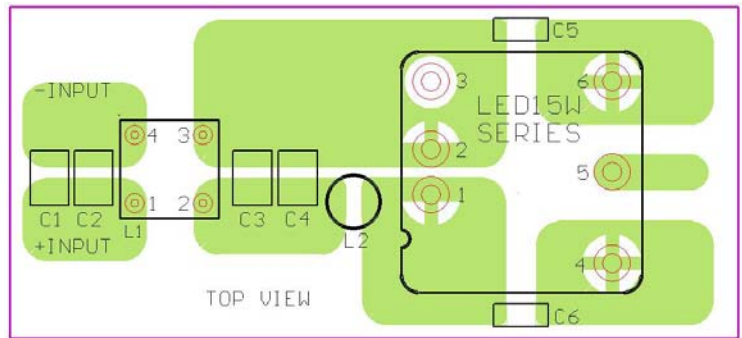
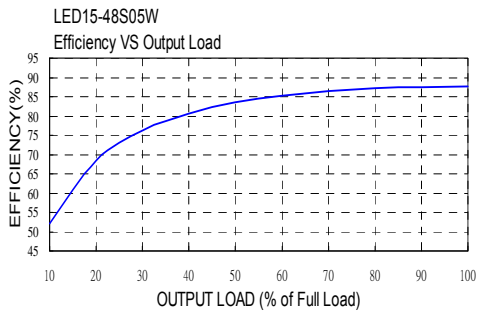
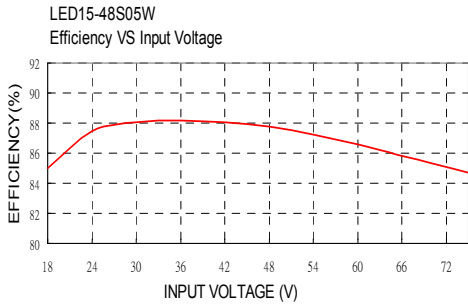

Recommended EN55022 Class B Filter Circuit Layout