

High-Voltage, $\pm 15\text{kV}$ ESD-Protected Electroluminescent Lamp Driver

MAX4990E

General Description

The MAX4990E high-voltage DC-AC converter is ideal for driving electroluminescent (EL) lamps. The MAX4990E features a wide +2.4V to +5.5V input range that allows the device to accept a wide variety of voltage sources such as single-cell lithium-ion (Li+) batteries and higher voltage battery chargers. The lamp outputs of the device generate up to 250V peak-to-peak output voltage for maximum lamp brightness.

The MAX4990E utilizes an inductor-based boost converter to generate the high voltage necessary to drive an EL lamp. The boost-converter switching frequency is set with the combination of an external capacitor connected from SW to GND and an external resistor connected from SLEW to GND.

The MAX4990E uses a high-voltage full-bridge output stage to convert the high voltage generated by the boost converter to an AC waveform suitable for driving the EL panel. The EL output switching frequency is set with the combination of an external capacitor connected from EL to GND and an external resistor connected from SLEW to GND.

The MAX4990E uses a proprietary acoustic noise-reduction circuit that controls the slew rate of the AC voltage, reducing audible noise from the EL panel. The slew rate is set with an external resistor connected from SLEW to GND.

The MAX4990E features an EL lamp dimming control (DIM) that allows the user to set the EL output voltage with a PWM signal, a DC analog voltage, or a resistor connected from the DIM input to GND. A capacitor placed in parallel to the resistor on DIM allows the user to program a slow turn-on/off time that generates a soft fade-on/fade-off effect of the EL lamp.

The MAX4990E enters a low-power shutdown mode (100nA max) when the EN and DIM inputs are connected to GND. The MAX4990E also enters thermal shutdown if the die temperature rises above +158°C.

The MAX4990E is available in a space-saving, 14-pin, 3mm x 3mm TDFN package and is specified over the extended -40°C to +85°C operating temperature range.

Typical Application Circuits appear at end of data sheet.

Features

- ◆ ESD-Protected EL Lamp Outputs
 - ±15kV Human Body Model
 - ±4kV IEC 61000-4-2 Contact Discharge
 - ±15kV IEC 61000-4-2 Air-Gap Discharge
- ◆ 250V_{p-p} (MAX) Output for Highest Brightness
- ◆ Wide +2.4V to +5.5V Input Voltage Range
- ◆ Resistor-Adjustable Slew-Rate Control for Audible Noise Reduction
- ◆ Externally Driven Lamp and Switching Converter Frequencies
- ◆ Capacitor-Adjustable Lamp and Switching Converter Frequencies
- ◆ Low 100nA Shutdown Current
- ◆ DIM Input for Controlling Output Voltage Through DC Analog Voltage, PWM, or Resistor to GND
- ◆ Capacitor Adjustable for Slow Turn-On/Off
- ◆ Space-Saving Packages
 - 14-Pin, 3mm x 3mm TDFN

Applications

Keypad Backlighting	PDA's/Smartphones
MP3 Players	Automotive Instrument Clusters
LCD Backlighting	

Pin Configuration

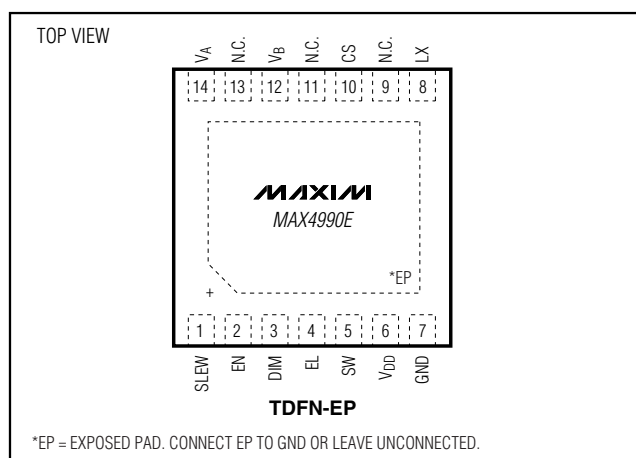

Ordering Information

PART	PIN-PACKAGE	TOP MARK	PKG CODE	$\pm 15\text{kV}$ PROTECTION	DIM CONTROL	SLEW-RATE CONTROL
MAX4990ETD+	14 TDFN-EP (3mm x 3mm)	ADL	T1433-2	Yes	Yes	Yes

Note: The device operates over the -40°C to +85°C operating temperature range.

+Denotes a lead-free package.
EP = Exposed paddle.

High-Voltage, ±15kV ESD-Protected Electroluminescent Lamp Driver

MAX4990E

ABSOLUTE MAXIMUM RATINGS

(All voltages referenced to GND.)

V _{DD}	-0.3V to +7V
CS, LX	-0.3V to +160V
V _A , V _B	-0.3V to (V _{CS} + 0.3V)
EN, EL, SLEW, DIM, SW	-0.3V to (V _{DD} + 0.3V)
Continuous Power Dissipation (T _A = +70°C)	
14-Pin TDFN (derate 24.4mW/°C above +70°C)	1951mW

J _A	41°C/W
Operating Temperature Range	-40°C to +85°C
Junction Temperature	+150°C
Storage Temperature Range	-65°C to +150°C
Lead Temperature (soldering, 10s)	+300°C

Stresses beyond those listed under "Absolute Maximum Ratings" may cause permanent damage to the device. These are stress ratings only, and functional operation of the device at these or any other conditions beyond those indicated in the operational sections of the specifications is not implied. Exposure to absolute maximum rating conditions for extended periods may affect device reliability.

ELECTRICAL CHARACTERISTICS

(V_{DD} = +2.4V to +5.5V, C_{LAMP} = 10nF, C_{CS} = 3.3nF, L_X = 220μH (I_{SAT} = 170mA, R_S = 5.5Ω), T_A = T_{MIN} to T_{MAX}, unless otherwise noted. Typical values are at V_{DD} = +3.0V and T_A = +25°C.) (Note 1)

PARAMETER	SYMBOL	CONDITIONS	MIN	TYP	MAX	UNITS
Power-Supply Voltage	V _{DD}		2.4		5.5	V
Power-Supply Current	I _{DD}	R _{SLEW} = 375kΩ, slope = 30V/100μs; f _{EL} = 200Hz, V _A - V _B = 250V _{P-P}			350	μA
Shutdown Supply Current	I _{SHDN}	EN = 0V, DIM = 0V, T _A = +25°C		25	100	nA
		EN = 0V, DIM = 0V, T _A = -40°C to +85°C			300	
Shutdown Inductor Supply Current	I _{LXSHDN}	EN = 0V, DIM = 0V, L _X = V _{DD} , CS = V _{DD}			1500	nA
Undervoltage Lockout	V _{LO}	V _{DD} rising	1.8	2.1	2.3	V
UVLO Hysteresis	V _{HYST}			125		mV
EL OUTPUTS (V_A - V_B)						
Peak-to-Peak Output Voltage	V _A - V _B	V _{DD} = +3V, DIM = +0.5V	84	100	122	V
		V _{DD} = +3V, DIM = +1V	170	200	230	
		V _{DD} = +3V, DIM = +1.3V	210	250	280	
Pulldown Switch On-Resistance	R _{ONPD}	I _{SINK} = 1mA, V _{CS} = +10V, V _A , V _B < +0.6V, V _{DD} = +3V	50	165	500	Ω
Pullup Switch On-Resistance	R _{ONPU}	V _{CS} = +125V, I _{SOURCE} = 1mA	700	1500	2200	Ω
Switch Off-Leakage	I _{LKG_NMOS}	V _A = +125V, V _B = +125V, shutdown mode, V _{CS} = +125V	-1		+1	μA
	I _{LKG_P MOS}	V _A = 0V, V _B = unconnected, shutdown mode, V _{CS} = +125V	-60		+60	
V _A , V _B Differential Resistor	V _{AB_RES}	V _A = +0.1V, V _B = 0V, shutdown mode, CS = unconnected	2		7	MΩ
EL Lamp Switching Frequency	f _{EL}	C _{EL} = 872pF, R _{SLEW} = 375kΩ	210	250	290	Hz
ESD Protection (V _A , V _B Only)		Human Body Model		±15		kV
		IEC 61000-4-2 Contact Discharge		±4		
		IEC 61000-4-2 Air-Gap Discharge		±15		

High-Voltage, ±15kV ESD-Protected Electroluminescent Lamp Driver

MAX4990E

ELECTRICAL CHARACTERISTICS (continued)

($V_{DD} = +2.4V$ to $+5.5V$, $C_{LAMP} = 10nF$, $C_{CS} = 3.3nF$, $L_X = 220\mu H$ ($I_{SAT} = 170mA$, $R_S = 5.5\Omega$), $T_A = T_{MIN}$ to T_{MAX} , unless otherwise noted. Typical values are at $V_{DD} = +3.0V$ and $T_A = +25^\circ C$.) (Note 1)

PARAMETER	SYMBOL	CONDITIONS	MIN	TYP	MAX	UNITS
BOOST CONVERTER						
Output Peak Voltage	V_{CS}	$V_{DD} = +3V$, DIM = +0.5V forced externally	42	50	61	V
		$V_{DD} = +3V$, DIM = +1V forced externally	85	100	115	
		$V_{DD} = +3V$, DIM = +1.3V forced externally	105	125	140	
Boost Switching Frequency	f_{SW}	$C_{SW} = 96pF$, $R_{SLEW} = 375k\Omega$	80	100	120	kHz
Switch On-Resistance	R_{LX}	$I_{SINK} = 25mA$, $V_{DD} = +3V$			20	Ω
LX Leakage Current	I_{LX}	$V_{LX} = +125V$	-1		+1	μA
CS Input Current	I_{CS}	No load, $V_{CS} = +125V$, EN = 0V, DIM = 0V			50	μA
CONTROL INPUT SW						
Input Voltage-High Threshold	V_{IH_SW}	$R_{SLEW} = 375k\Omega$	0.9	0.98	1.06	V
Input Voltage-Low Threshold	V_{IL_SW}	$R_{SLEW} = 375k\Omega$	0.43	0.49	0.55	V
Input Low Current	I_{IL_SW}	$R_{SLEW} = 375k\Omega$, CS = +40V, EL = V_{DD} , DIM = V_{DD}	43		77	μA
Input High Current	I_{IH_SW}	$R_{SLEW} = 375k\Omega$, CS = +40V, EL = V_{DD} , DIM = V_{DD}	5.0		7.5	μA
CONTROL INPUT EL						
Input Voltage-High Threshold	V_{IH_CEL}	$R_{SLEW} = 375k\Omega$	1.08		1.32	V
Input Voltage-Low Threshold	V_{IL_CEL}	$R_{SLEW} = 375k\Omega$	0.22		0.39	V
Input Low Current	I_{IL_CEL}	$R_{SLEW} = 375k\Omega$	1.2		1.87	μA
Input High Current	I_{IH_CEL}	$R_{SLEW} = 375k\Omega$	1.2		1.87	μA
CONTROL INPUT SLEW						
Force Voltage	V_{FORCE}	$I_{SOURCE} = 20\mu A$	0.89	0.95	1.04	V
High-Voltage Output Slew Rate		$R_{SLEW} = 375k\Omega$		30		V/100 μs
CONTROL INPUT DIM						
Input Logic-High Voltage	V_{IH_DIM}	Output voltage (max)	1.3			V
Input Logic-Low Voltage	V_{IL_DIM}	Output voltage (off)			0.15	V
Input Low Current	I_{IL_DIM}	$V_{DIM} = 0V$, $R_{SLEW} = 375k\Omega$	2.22		3.0	μA
Input High Current	I_{IH_DIM}	$V_{DIM} = V_{DD}$	-1		+1	μA
PWM Frequency Range				0.2 to 1		MHz
Low-Peak Detector Threshold	V_{LPD}		0.15		0.35	V
Low-Peak Detector Hysteresis	V_{LPD_HYST}			100		mV
CONTROL INPUT EN						
Input Voltage-High Threshold	V_{IH_EN}		1.2			V
Input Voltage-Low Threshold	V_{IL_EN}				0.2	V
Input Low Current	I_{IL_EN}		-1		+1	μA
Input High Current	I_{IH_EN}		-1		+1	μA

High-Voltage, ±15kV ESD-Protected Electroluminescent Lamp Driver

ELECTRICAL CHARACTERISTICS (continued)

($V_{DD} = +2.4V$ to $+5.5V$, $C_{LAMP} = 10nF$, $C_{CS} = 3.3nF$, $L_X = 220\mu H$ ($I_{SAT} = 170mA$, $R_S = 5.5\Omega$), $T_A = T_{MIN}$ to T_{MAX} , unless otherwise noted. Typical values are at $V_{DD} = +3.0V$ and $T_A = +25^\circ C$.) (Note 1)

PARAMETER	SYMBOL	CONDITIONS	MIN	TYP	MAX	UNITS
THERMAL SHUTDOWN						
Thermal Shutdown				158		$^\circ C$
Thermal Shutdown Hysteresis				8		$^\circ C$

Note 1: Specifications at $T_A = -40^\circ C$ are guaranteed by design and not production.

Typical Operating Characteristics

($V_{DD} = +3.6V$, $C_{LAMP} = 10nF$, $C_{CS} = 3.3nF$, $L_X = 220\mu H$ ($I_{SAT} = 170mA$, $R_S = 5.5\Omega$), $R_{SLEW} = 390k\Omega$, $DIM = V_{DD}$, $C_{SW} = 100pF$, $C_{EL} = 1.2nF$, $T_A = +25^\circ C$, unless otherwise noted.)

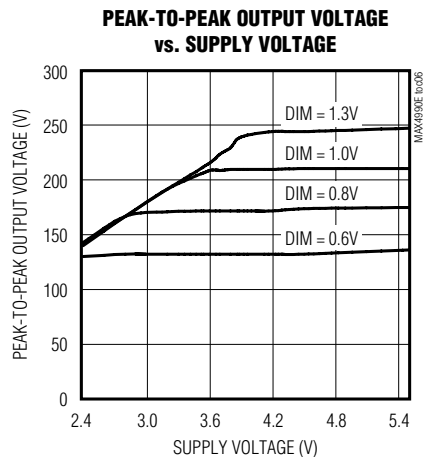
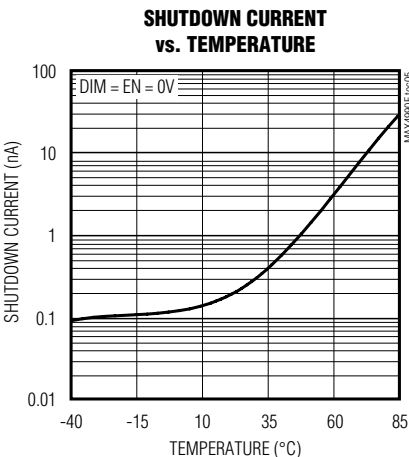
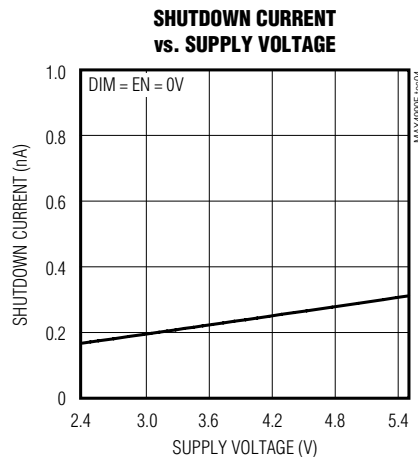
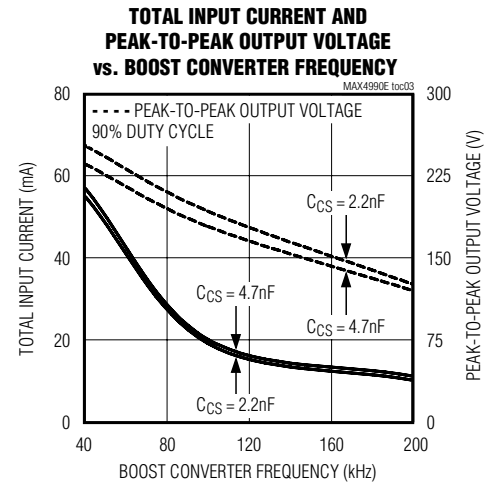
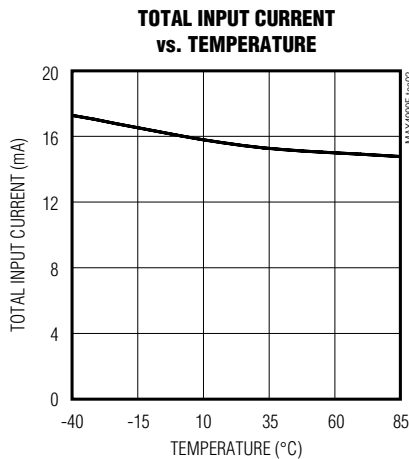
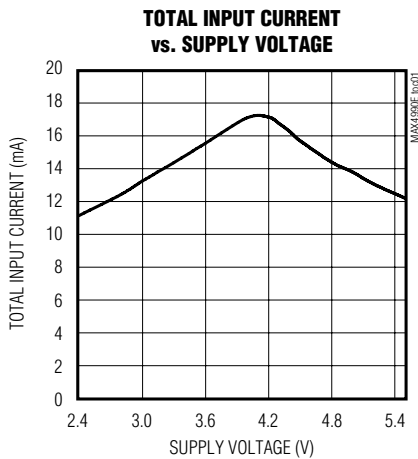

High-Voltage, ±15kV ESD-Protected Electroluminescent Lamp Driver

MAX4990E

Typical Operating Characteristics (continued)

($V_{DD} = +3.6V$, $C_{LAMP} = 10nF$, $C_{CS} = 3.3nF$, $L_X = 220\mu H$ ($I_{SAT} = 170mA$, $R_S = 5.5\Omega$), $R_{SLEW} = 390k\Omega$, $DIM = V_{DD}$, $C_{SW} = 100pF$, $C_{EL} = 1.2nF$, $T_A = +25^\circ C$, unless otherwise noted.)

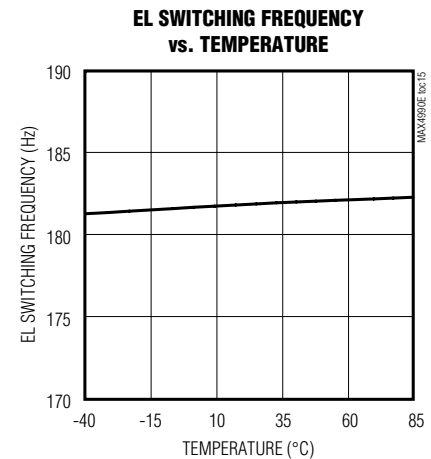
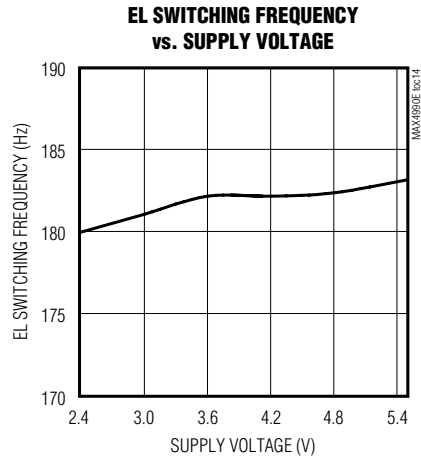
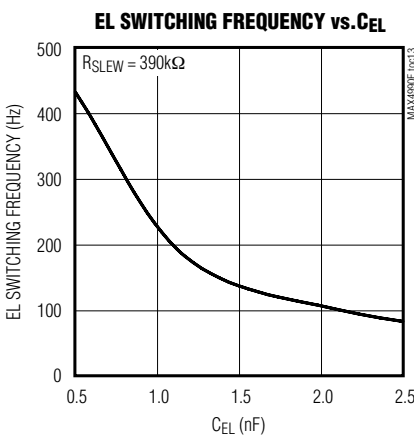
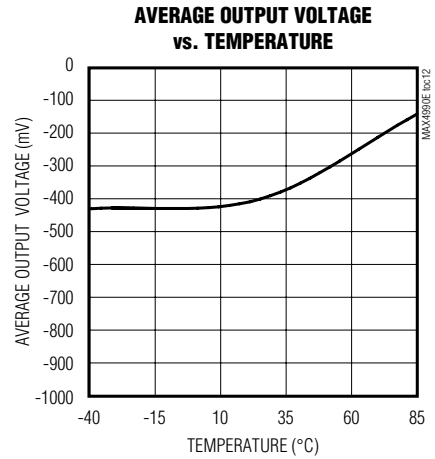
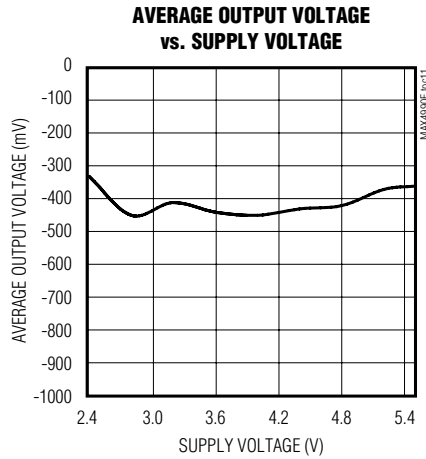
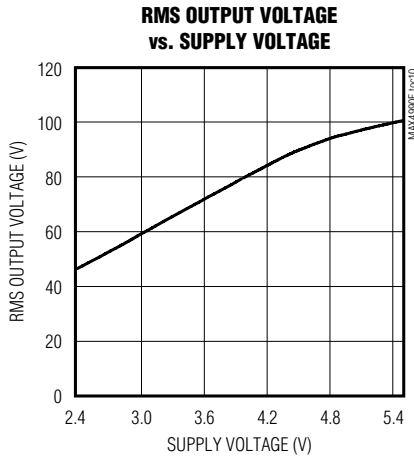
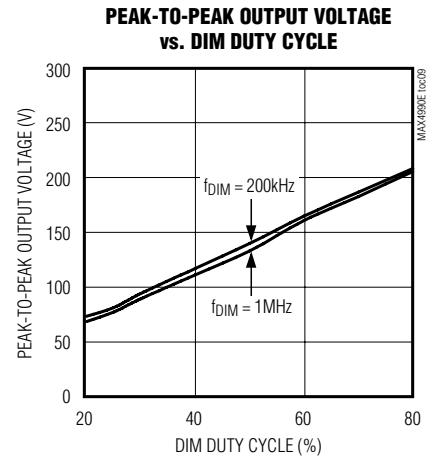
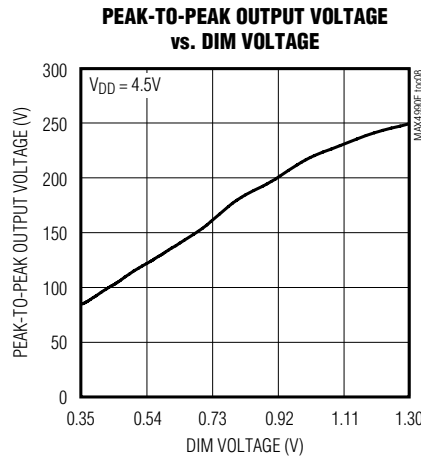
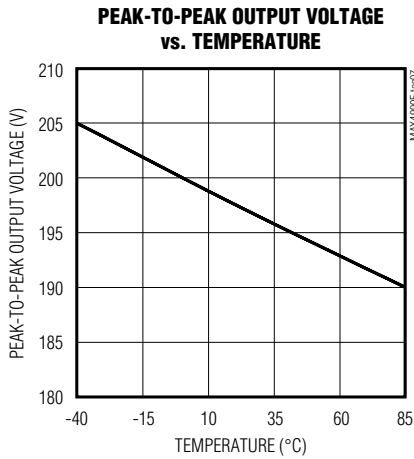

High-Voltage, ±15kV ESD-Protected Electroluminescent Lamp Driver

Typical Operating Characteristics (continued)

($V_{DD} = +3.6V$, $C_{LAMP} = 10nF$, $C_{CS} = 3.3nF$, $L_X = 220\mu H$ ($I_{SAT} = 170mA$, $R_S = 5.5\Omega$), $R_{SLEW} = 390k\Omega$, $DIM = V_{DD}$, $C_{SW} = 100pF$, $C_{EL} = 1.2nF$, $T_A = +25^\circ C$, unless otherwise noted.)

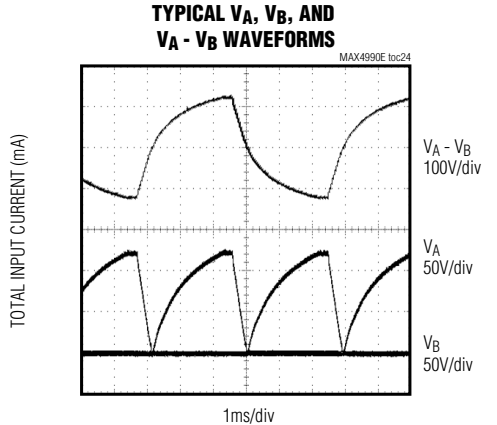
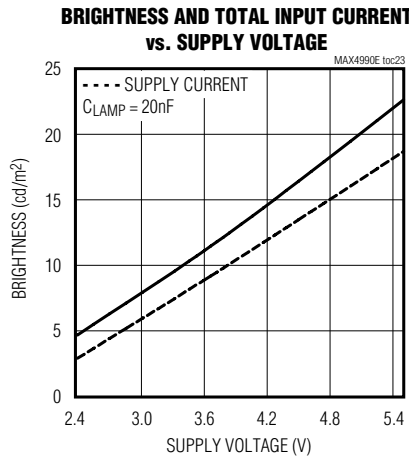
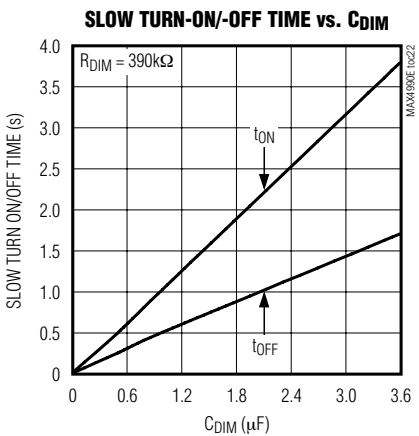
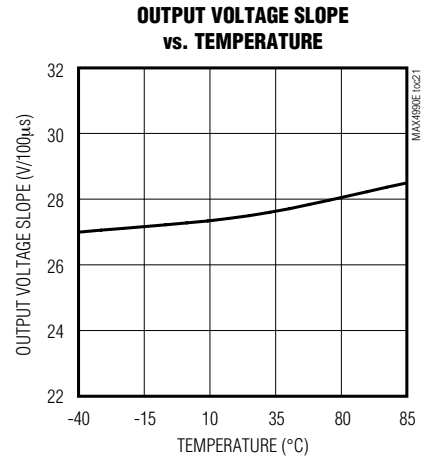
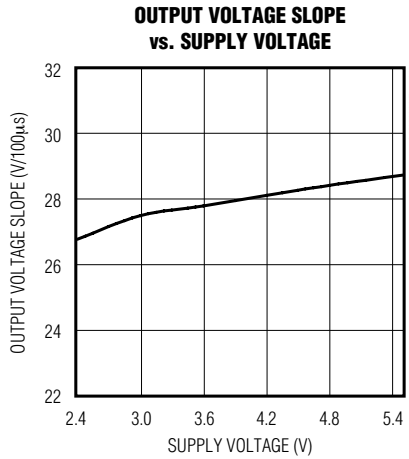
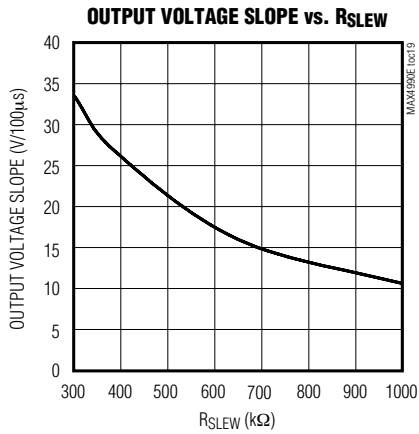
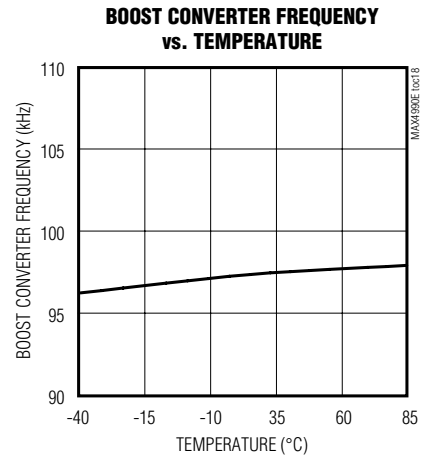
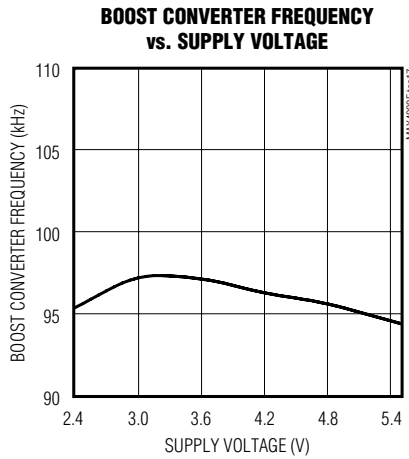
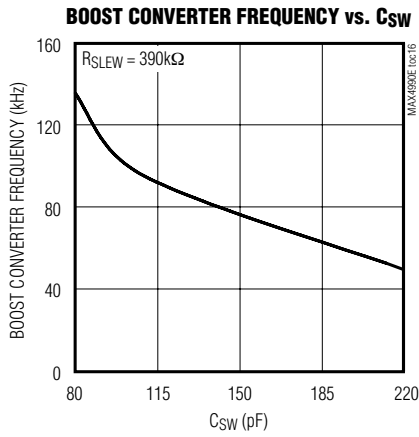

High-Voltage, $\pm 15\text{kV}$ ESD-Protected Electroluminescent Lamp Driver

Pin Description

MAX4990E

PIN	NAME	FUNCTION
1	SLEW	High-Voltage Slew-Rate Control. Connect an external resistor, R_{SLEW} , to GND to set the slew rate of the V_A and V_B high-voltage outputs.
2	EN	Enable Input. Drive $EN > +1.2\text{V}$ and $DIM > +0.35\text{V}$ to turn on the device. Drive $EN < +0.2\text{V}$ and $DIM < +0.15\text{V}$ to turn off the device.
3	DIM	EL Panel Dimming Control. Apply a PWM signal or DC analog control signal, or connect a resistor to GND to adjust peak-to-peak output voltage. Use DIM together with EN to control device shutdown (see <i>Shutdown</i> section).
4	EL	EL Voltage Switching Frequency. Connect an external capacitor, C_{EL} , to GND or drive with an external oscillator to set the switching frequency of the V_A and V_B high-voltage outputs. Connect EL to GND to shut off the EL oscillator. Drive EL high to keep alternatively V_A or V_B output high.
5	SW	Boost-Converter Switching Frequency. Connect an external capacitor, C_{SW} , to GND or drive with an external oscillator to set the switching frequency of the boost converter. Connect SW to GND to shut off the boost oscillator. Do not keep SW high to avoid LX shorting to GND, which causes the internal die temperature to increase. The MAX4990E is protected by entering a thermal-shutdown state. (See the <i>Thermal Short-Circuit Protection</i> section.)
6	VDD	Power-Supply Voltage
7	GND	Ground
8	LX	Internal Switching DMOS Drain Connection. Connect LX to a switching inductor and an anode of a rectifying diode.
9, 11, 13	N.C.	No Connection. Leave N.C. unconnected.
10	CS	High-Voltage Supply. Connect CS to output capacitor of boost converter.
12	V_B	High-Voltage EL Panel Output. Connect to non- V_A side of EL lamp.
14	V_A	High-Voltage EL Panel Output. Connect to non- V_B side of EL lamp.
EP	EP	Exposed Pad. Connect exposed pad to GND.

Detailed Description

The MAX4990E high-voltage DC-AC converter is ideal for driving EL lamps. The MAX4990E features a wide +2.4V to +5.5V input range that allows the device to accept a wide variety of voltage sources such as single cell Li+ batteries and higher voltage battery chargers. The lamp outputs of the device generate up to 250V peak-to-peak output voltage for maximum lamp brightness.

The MAX4990E utilizes an inductor-based boost converter that allows for the use of a 220 μH inductor to generate the high voltage necessary to drive an EL lamp. The boost converter switching frequency is set with the combination of an external capacitor connected from the SW input to GND and an external resistor connected from SLEW to GND. Applying a PWM signal to the SW input allows the switching frequency of the boost converter to take the frequency of the PWM signal.

The MAX4990E uses a high-voltage full-bridge output stage to convert the high voltage generated by the boost converter to an AC waveform suitable for driving the EL panel. The EL output switching frequency is set with the combination of an external capacitor connected from EL to GND and an external resistor connected from SLEW to GND. The MAX4990E allows programmability of the EL Lamp output frequency by applying a clock signal to the EL input. Applying a clock signal to the EL input allows the switching frequency of the lamp to take the frequency of the clock signal divided by 4 to switch at the EL input frequency divided by 4.

The MAX4990E uses a proprietary acoustic noise-reduction circuit to control the slew rate of the AC voltage, reducing audible noise from the EL panel. The slew rate is set with an external resistor connected from SLEW to GND.

The MAX4990E enters a low-power shutdown mode (100nA max) when EN and DIM inputs are connected

High-Voltage, $\pm 15\text{kV}$ ESD-Protected Electroluminescent Lamp Driver

MAX4990E

Functional Diagram

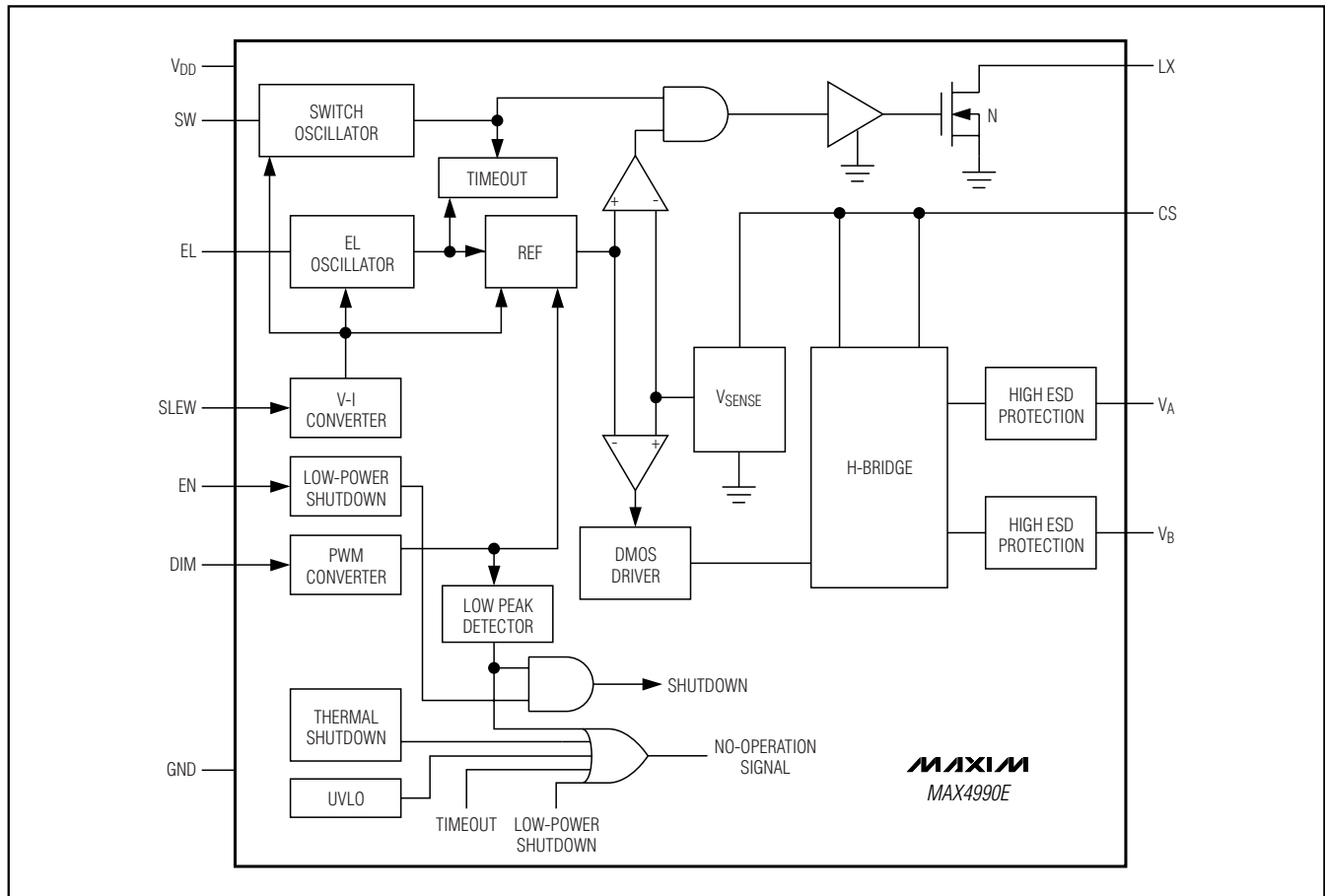

to GND. The MAX4990E also enters thermal shutdown if the die temperature rises above $+158^{\circ}\text{C}$.

The MAX4990E features an EL lamp dimming control (DIM) that allows the user to set the EL output voltage with a PWM, DC analog voltage, or a resistor connected to GND. A capacitor placed in parallel to the resistor on the DIM input allows the user to program a slow turn-on/off time of the MAX4990E's outputs to generate a soft fade-on/fade-off effect of the EL lamp.

The high-voltage outputs are ESD protected up to $\pm 15\text{kV}$ Human Body Model, $\pm 15\text{kV}$ Air-Gap Discharge, and $\pm 4\text{kV}$ Contact Discharge, as specified in the IEC 61000-4-2 specification.

EL Output Voltage

The slew rate, frequency, and peak-to-peak voltage of the MAX4990E EL lamp outputs are programmed through a combination of external components and/or DC inputs.

The device uses resistor R_{SLEW} to set the bias current used as a reference current for the MAX4990E internal circuitry. The reference current directly affects the slew rate of the EL lamp output. Increasing the value of R_{SLEW} decreases the slew rate, and decreasing the value of R_{SLEW} increases the slew rate. (See the *R_{SLEW} Resistor Selection* section on how to select R_{SLEW} .)

The MAX4990E EL lamp output frequency uses an internal EL oscillator to set the desired frequency. The output frequency is adjusted by either 1) the combination of a resistor from SLEW to GND and an external capacitor from the EL input to GND, or 2) by driving a clock signal directly into the EL input. (See the *CEL Capacitor Selection* section for choosing the CEL capacitor value.)

The peak-to-peak voltage of the EL lamp output is varied from $70\text{V}_{\text{P-P}}$ to $250\text{V}_{\text{P-P}}$ by applying an external DC voltage ranging from $+0.35\text{V}$ to $+1.3\text{V}$ to the DIM input.

High-Voltage, $\pm 15\text{kV}$ ESD-Protected Electroluminescent Lamp Driver

MAX4990E

Increasing the voltage on the DIM input increases the peak-to-peak voltage, and decreasing the voltage on the input decreases the peak-to-peak voltage. The EL lamp peak-to-peak voltage is also adjusted by applying a PWM signal to the DIM input. The duty cycle of the PWM determines the EL lamp output peak-to-peak voltage. As the duty cycle is increased, the peak-to-peak output voltage is increased, and as the duty cycle is decreased, the peak-to-peak voltage is decreased. The MAX4990E also features a slow turn-on and slow turn-off time feature that is enabled by connecting a resistor and capacitor from DIM to GND (see the *Typical Application Circuits* and the *R_{DIM} Resistor and C_{DIM} Capacitor Selection* section). This slow turn-on/off feature causes the peak-to-peak voltage of the EL outputs to slowly rise from zero to the maximum set value when the device is enabled. This feature also causes the peak-to-peak voltage of the EL outputs to fall from the maximum set value to zero when the device is placed into shutdown. The slow rise and fall of the peak-to-peak EL output voltage creates a soft fade-on and fade-off of the EL lamp, rather than an abrupt change in brightness.

Boost Converter

The MAX4990E boost converter consists of an external inductor from V_{DD} to the LX input, an internal DMOS switch, an external diode from LX to the CS output, an external capacitor from the CS output to GND, and the EL lamp, CLAMP, connected to the EL lamp outputs. When the DMOS switch is turned on, LX is connected to GND, and the inductor is charged. When the DMOS switch is turned off, the energy stored in the inductor is transferred to the capacitor C_{CS} and the EL lamp.

Note: Keeping SW high shorts LX to GND, causing the internal die temperature to increase. The MAX4990E is protected by entering a thermal-shutdown state (See the *Thermal Short-Circuit Protection* section.)

The MAX4990E boost converter frequency uses an internal switch oscillator to set the desired frequency of the boost converter. The boost converter frequency is adjusted by either 1) the combination of a resistor from SLEW to GND and an external capacitor from SW to GND, or 2) by driving a PWM signal directly into the SW input. When SW is driven with an external PWM signal at a suggested 90% duty cycle, the boost converter frequency is changed to the frequency of the external PWM signal. (See the *C_{SW} Capacitor Selection* section for choosing the C_{SW} capacitor value.)

Dimming Control

The MAX4990E features a dimming control input, DIM, that controls the peak-to-peak voltage on the lamp outputs V_A and V_B. DIM is controlled by a resistor con-

nected from the DIM input to GND, a PWM signal applied to the DIM input, or a DC voltage applied to the DIM input. (See the *R_{DIM} Resistor and C_{DIM} Capacitor Selection* section.)

The duty cycle of a PWM signal to the DIM input is internally translated into a DC voltage with the 0 to +1.22V range. The DIM input accepts the frequency range of 200kHz to 1MHz. As the duty cycle increases, the peak-to-peak voltage of the output increases, and as the duty cycle decreases, the peak-to-peak voltage of the output decreases.

The peak-to-peak voltage is adjusted by applying a DC voltage to the DIM input. Increasing the voltage on DIM increases the peak-to-peak output, and decreasing the voltage on DIM decreases the peak-to-peak output voltage.

The DIM input, in combination with the EN input, controls the shutdown mode of the MAX4990E shutdown. (See the *Shutdown* section.)

Slow Turn-On, Slow Turn-Off

The MAX4990E provides a slow turn-on/off feature by connecting a resistor in parallel with a capacitor connected from the DIM input to GND (see the *R_{DIM} Resistor and C_{DIM} Capacitor Selection* section). When EN is driven high, the reference current I_B (set by R_{SLEW}) is used to charge capacitor C_{DIM}. When EN is driven to GND, I_B is removed, and the voltage on the capacitor C_{DIM} and resistor decays with a time constant of R_{DIM} × C_{DIM}. A slow turn-on effect is seen by driving EN high. The slow rise and fall of the voltage on DIM during transitions on the EN input modulates the peak-to-peak voltage of the EL outputs, creating a soft fade-on/-off effect at the EL lamp.

Shutdown

The MAX4990E features an enable logic input, EN, to enable and disable the device. To enable the device, apply +1.2V or greater to the EN input and +0.35V or greater to the DIM input. To place the device in shutdown, apply +0.2V or less to the EN input, and +0.15V or less to the DIM input.

Undervoltage Lockout (UVLO)

The MAX4990E has a UVLO threshold of +2.1V (typ). When V_{DD} falls below +2.1V (typ), the device enters a nonoperative mode.

Thermal Short-Circuit Protection

The MAX4990E enters a nonoperative mode if the internal die temperature of the device reaches or exceeds +158°C (typ). The device turns back on when the internal die temperature cools to +150°C.

High-Voltage, $\pm 15\text{kV}$ ESD-Protected Electroluminescent Lamp Driver

$\pm 15\text{kV}$ ESD Protection

As with all Maxim devices, ESD-protection structures are incorporated on all pins to protect against electrostatic discharges encountered during handling and assembly. The EL lamp driver outputs of the MAX4990E have extra protection against static electricity. Maxim's engineers have developed state-of-the-art structures to protect these pins against ESD of $\pm 15\text{kV}$ without damage. The ESD structures withstand high ESD in all states: normal operation, shutdown, and powered down. After an ESD event, the MAX4990E keep working without latchup or damage.

ESD protection can be tested in various ways. The transmitter EL lamp outputs of the MAX4990E are characterized for protection to the following limits:

- $\pm 15\text{kV}$ using the Human Body Model
- $\pm 4\text{kV}$ IEC 61000-4-2 Contact Discharge
- $\pm 15\text{kV}$ IEC 61000-4-2 Air-Gap Discharge

ESD Test Conditions

ESD performance depends on a variety of conditions. Contact Maxim for a reliability report that documents test setup, test methodology, and test results.

Human Body Model

Figure 1a shows the Human Body Model, and Figure 1b shows the current waveform it generates when discharged into a low impedance. This model consists of a 100pF capacitor charged to the ESD voltage of interest, which is then discharged into the test device through a $1.5\text{k}\Omega$ resistor.

IEC 61000-4-2

The IEC 61000-4-2 standard covers ESD testing and performance of finished equipment. However, it does not specifically refer to integrated circuits. The MAX4990E assists in designing equipment to meet IEC 61000-4-2 without the need for additional ESD-protection components.

The major difference between tests done using the Human Body Model and IEC 61000-4-2 is higher peak current in IEC 61000-4-2 because series resistance is lower in the IEC 61000-4-2 model. Hence, the ESD withstand voltage measured to IEC 61000-4-2 is generally lower than that measured using the Human Body Model. Figure 1c shows the IEC 61000-4-2 model, and Figure 1d shows the current waveform for IEC 61000-4-2 ESD Contact Discharge test.

Machine Model

The machine model for ESD tests all pins using a 200pF storage capacitor and zero discharge resistance.

The objective is to emulate the stress caused when I/O pins are contacted by handling equipment during test and assembly. Of course, all pins require this protection.

The Air-Gap test involves approaching the device with a charged probe. The Contact Discharge method connects the probe to the device before the probe is energized.

Design Procedure

L_x Inductor Selection

The recommended inductor values are $220\mu\text{H}/330\mu\text{H}$. For most applications, series resistance (DCR) should be below 8Ω for reasonable efficiency. Do not exceed the inductor's saturation current.

RSLEW Resistor Selection

To help reduce audible noise emission by the EL lamp, the MAX4990E features a slew-rate control input (SLEW) that allows the user to set the slew-rate of the high-voltage outputs, V_A and V_B , by connecting a resistor, R_{SLEW} , from the SLEW input to GND. R_{SLEW} precisely sets the reference current I_B that is used to charge and discharge the capacitances at the SW input and EL input, and is used as a reference current for internal circuitry. The reference current is related to R_{SLEW} by the following equation: $I_B = 1V/R_{SLEW}$. Decreasing the value of R_{SLEW} increases I_B and increases the slew rate at the EL lamp output. Increasing the value of R_{SLEW} decreases I_B and decreases the slew rate at the EL lamp output. The output slew rate is related to R_{SLEW} by the following equation:

$$\text{SlewRate} \left(\frac{\text{V}}{100\mu\text{s}} \right) = \frac{11.25}{R_{SLEW}(\text{M}\Omega)}$$

The ideal value for a given design varies depending on lamp size and mechanical enclosure. Typically, the best slew rate for minimizing audible noise is between $10\text{V}/100\mu\text{s}$ and $20\text{V}/100\mu\text{s}$. This results in R_{SLEW} values ranging from $1.125\text{M}\Omega$ to $0.5625\text{M}\Omega$. For example, if the desired slew rate is $20 (\text{V}/100\mu\text{s})$, this leads to an R_{SLEW} resistor value in $\text{M}\Omega$ of $R_{SLEW} = 11.25/20\text{V} = 0.5625\text{M}\Omega$.

Note: Connecting R_{SLEW} to GND will not damage the device. However, for the device to operate correctly, R_{SLEW} should be in the $100\text{k}\Omega$ to $2.2\text{M}\Omega$ range.

R_{SLEW} also affects the frequency of the boost converter (see the *C_{SW} Capacitor Selection*), the frequency of the EL lamp (see the *C_{EL} Capacitor Selection* section), and the peak-to-peak voltage of the EL lamp.

High-Voltage, ±15kV ESD-Protected Electroluminescent Lamp Driver

MAX4990E

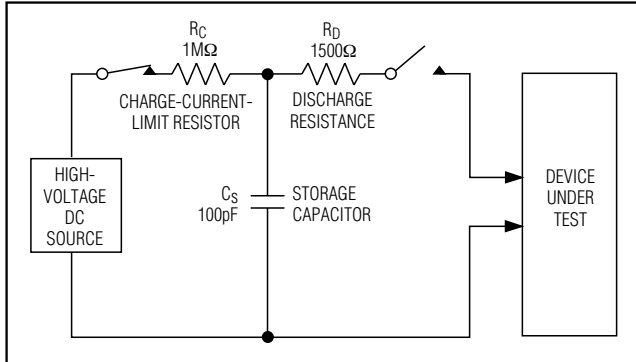

Figure 1a. Human Body ESD Test Model

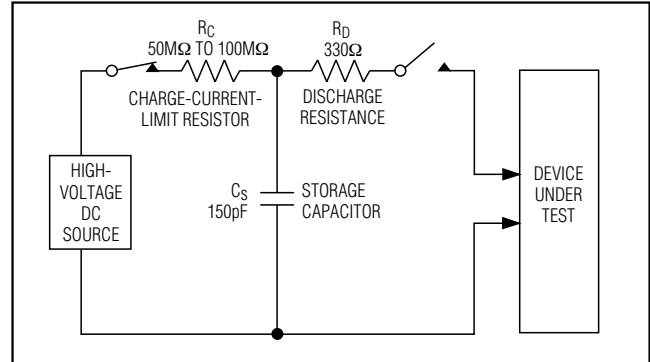

Figure 1c. IEC 61000-4-2 ESD Test Model

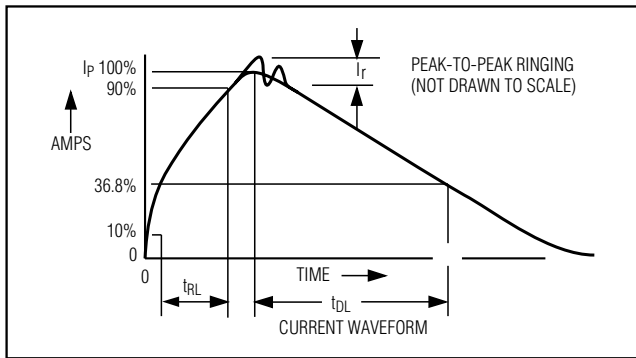

Figure 1b. Human Body Current Waveform

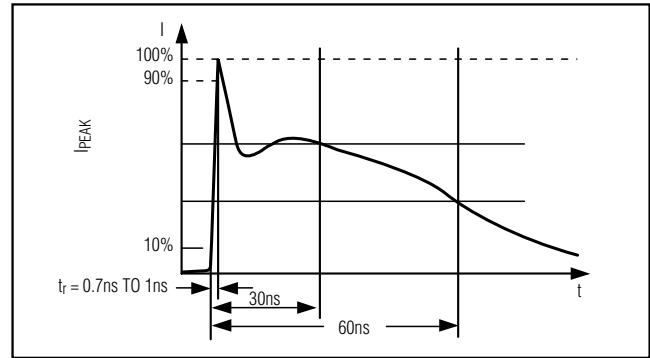

Figure 1d. IEC 61000-4-2 ESD Generator Current Waveform

Table 1. Inductor Vendors

INDUCTOR VALUE (μH)	VENDOR	WEBSITE	PART
220	TOKO	www.tokoam.com	D312C 1001BS-221M
330	Coilcraft	www.coilcraft.com	DO1608C-334ML
470	Coilcraft	www.coilcraft.com	DO1608C-474ML
220	Coilcraft	www.coilcraft.com	LPS4018-224ML
330	Coilcraft	www.coilcraft.com	LPS4018-334ML
470	Coilcraft	www.coilcraft.com	LPS4018-474ML

The peak-to-peak voltage is adjusted by connecting a resistor from the SLEW input to GND together with a resistor from the DIM input to GND. The equation relating the peak-to-peak voltage to the resistors is the following:

$$V_{P-P} = 200 \times \frac{R_{DIM}}{R_{SLEW}}$$

R_{DIM} Resistor and C_{DM} Capacitor Selection

The MAX4990E provides a slow turn-on/off feature by connecting a resistor in parallel with a capacitor connected from the DIM input to GND. The reference current I_B is used to charge the resistor and capacitor. When EN is driven to GND, I_B is removed, and the voltage across the capacitor and resistor decay with a time constant of RC that provides a slow turn off of the EL

High-Voltage, ±15kV ESD-Protected Electroluminescent Lamp Driver

MAX4990E

lamp outputs. A slow turn-on effect is produced by driving EN high. Slow turn-on/-off time is related by the following equation:

$$t_{ON} = 2.6 \times R_{DIM} \times C_{DIM}$$

$$t_{OFF} = 1.2 \times R_{DIM} \times C_{DIM}$$

For this equation to be valid, R_{DIM}/R_{SLEW} must be ≤ 1.3 .

CCS Capacitor Selection

CCS is the output of the boost converter and provides the high-voltage source for the EL lamp. Connect a 3.3nF capacitor from CS to GND and place as close to the CS input as possible. When using an inductor value larger than 220μH, it may be necessary to increase the CCS. For a $LX = 470\mu H$ and $C_{LAMP} = 20nF$, a CCS ranging from 3.3nF to 6.8nF is recommended.

CEL Capacitor Selection

The MAX4990E EL lamp output frequency is set by connecting a capacitor from the EL input to GND together with a resistor from SLEW to GND or by driving the EL input with an external clock (0 to +1.5V). The EL lamp output frequency is related to the CEL capacitor by the following equation:

$$f_{EL} = \frac{0.0817}{R_{SLEW} \times C_{EL}}$$

For example, an $R_{SLEW} = 375k\Omega$ and a CEL capacitor value of 1000pF equals an EL lamp output frequency of $f_{EL} = 217Hz$.

CSW Capacitor Selection

The boost converter switching frequency is set by connecting a capacitor from the SW input to GND, together with the resistance from the SLEW input to GND, or driving the SW input with an external clock (0 to +1.5V). The switching frequency of the boost converter is related to the capacitor from SW to GND by the following equation:

$$f_{SW} = \frac{3.61}{R_{SLEW} \times C_{SW}}$$

Connect the SW input to GND to turn the switch oscillator of the boost converter off. Although the optimal f_{SW} depends on the inductor value, the suggested f_{SW} range is 20kHz to 150kHz.

Note: Driving SW with a logic-high causes LX to be driven to GND. Keeping SW high shorts LX to GND, causing the internal die temperature to increase. The MAX4990E is protected by entering a thermal-shutdown state. (See the *Thermal Short-Circuit Protection* section.)

CB Capacitor Selection

Bypass VDD with a 0.1μF ceramic capacitor as close to the IC as possible and a 4.7μF ceramic capacitor as close to the inductor as possible.

Diode Selection

Connect a diode, D1, from the LX node to CS to rectify the boost voltage on CS. The diode should be a fast-recovery diode that is tolerant to +150V.

EL Lamp Selection

EL lamps have a capacitance of approximately 2.5nF to 3.5nF per square inch. The MAX4990E effectively charges capacitance ranging from 2nF to 20nF.

Applications Information

PCB Layout

Keep PCB traces as short as possible. Ensure that bypass capacitors are as close to the device as possible. Use large ground planes where possible.

Chip Information

PROCESS: BiCMOS-DMOS

High-Voltage, ±15kV ESD-Protected Electroluminescent Lamp Driver

Typical Application Circuits

MAX4990E

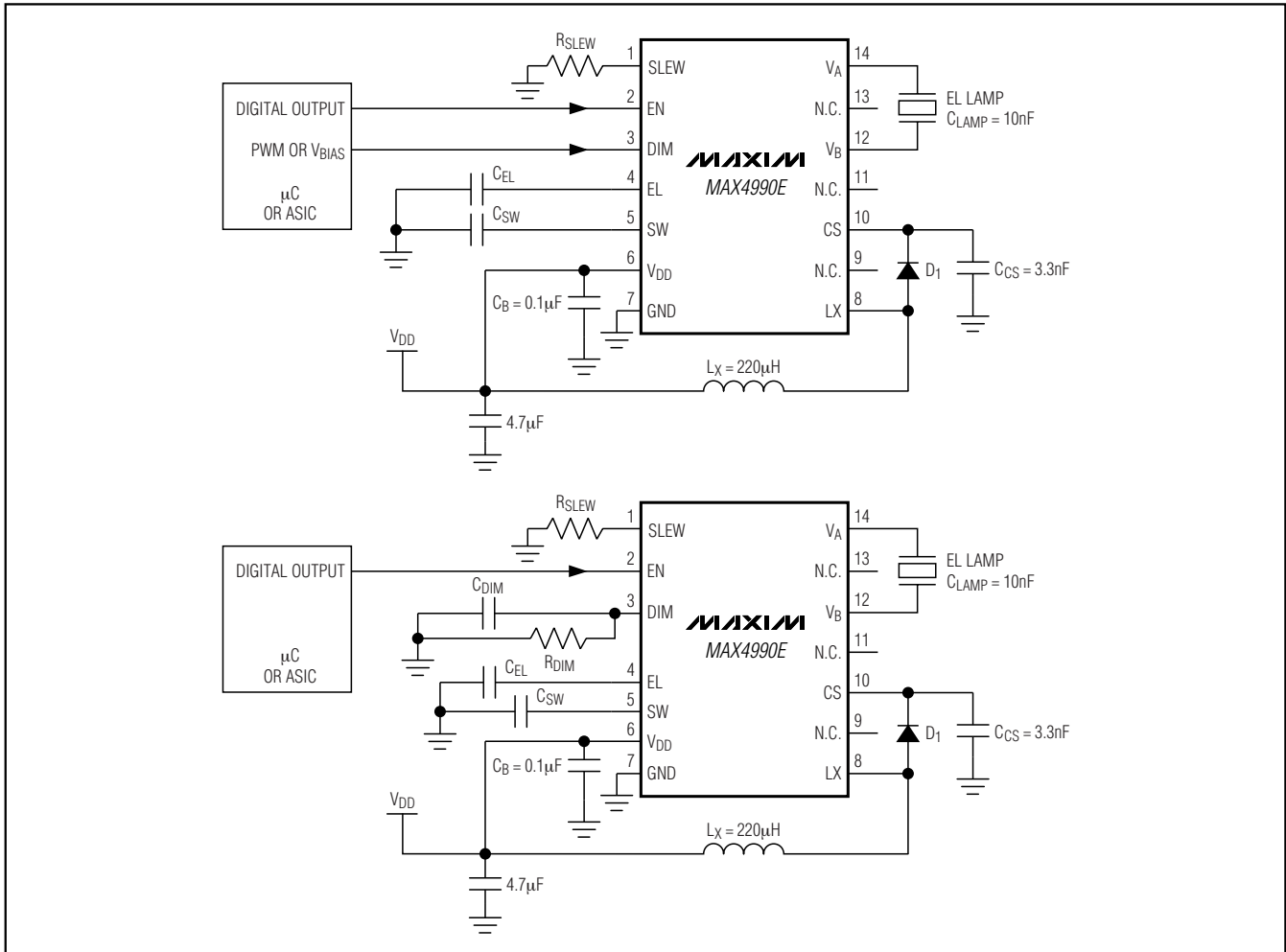

High-Voltage, ±15kV ESD-Protected Electroluminescent Lamp Driver

MAX4990E

Package Information

(The package drawing(s) in this data sheet may not reflect the most current specifications. For the latest package outline information, go to www.maxim-ic.com/packages.)

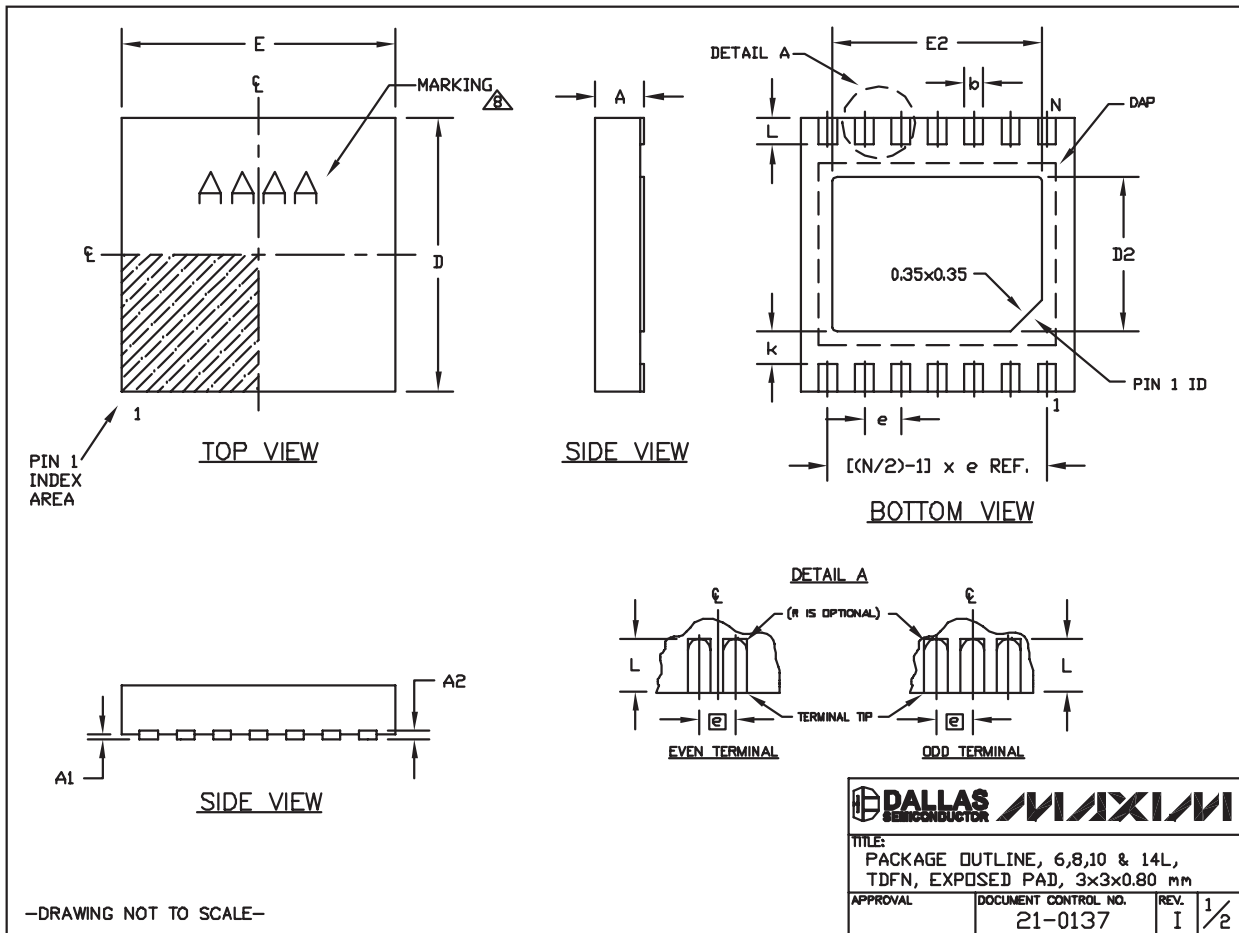

6, 8, & 10L, DFN THINERPS

High-Voltage, ±15kV ESD-Protected Electroluminescent Lamp Driver

Package Information (continued)

(The package drawing(s) in this data sheet may not reflect the most current specifications. For the latest package outline information, go to www.maxim-ic.com/packages.)

MAX4990E

COMMON DIMENSIONS		
SYMBOL	MIN.	MAX.
A	0.70	0.80
D	2.90	3.10
E	2.90	3.10
A1	0.00	0.05
L	0.20	0.40
k	0.25 MIN.	
A2	0.20 REF.	

PACKAGE VARIATIONS							
PKG. CODE	N	D2	E2	e	JEDEC SPEC	b	[(N/2)-1] x e
T633-2	6	1.50±0.10	2.30±0.10	0.95 BSC	MO229 / WEEA	0.40±0.05	1.90 REF
T833-2	8	1.50±0.10	2.30±0.10	0.65 BSC	MO229 / WEEC	0.30±0.05	1.95 REF
T833-3	8	1.50±0.10	2.30±0.10	0.65 BSC	MO229 / WEEC	0.30±0.05	1.95 REF
T1033-1	10	1.50±0.10	2.30±0.10	0.50 BSC	MO229 / WEED-3	0.25±0.05	2.00 REF
T1033-2	10	1.50±0.10	2.30±0.10	0.50 BSC	MO229 / WEED-3	0.25±0.05	2.00 REF
T1433-1	14	1.70±0.10	2.30±0.10	0.40 BSC	----	0.20±0.05	2.40 REF
T1433-2	14	1.70±0.10	2.30±0.10	0.40 BSC	----	0.20±0.05	2.40 REF

NOTES:

1. ALL DIMENSIONS ARE IN mm. ANGLES IN DEGREES.
 2. COPLANARITY SHALL NOT EXCEED 0.08 mm.
 3. WARPAGE SHALL NOT EXCEED 0.10 mm.
 4. PACKAGE LENGTH/PACKAGE WIDTH ARE CONSIDERED AS SPECIAL CHARACTERISTIC(S).
 5. DRAWING CONFORMS TO JEDEC MO229, EXCEPT DIMENSIONS "D2" AND "E2", AND T1433-1 & T1433-2.
 6. "N" IS THE TOTAL NUMBER OF LEADS.
 7. NUMBER OF LEADS SHOWN ARE FOR REFERENCE ONLY.
-  MARKING IS FOR PACKAGE ORIENTATION REFERENCE ONLY.

—DRAWING NOT TO SCALE—

			
TITLE: PACKAGE OUTLINE, 6,8,10 & 14L, TDFN, EXPOSED PAD, 3x3x0.80 mm			
APPROVAL	DOCUMENT CONTROL NO.	REV.	2/2
	21-0137	I	

Maxim cannot assume responsibility for use of any circuitry other than circuitry entirely embodied in a Maxim product. No circuit patent licenses are implied. Maxim reserves the right to change the circuitry and specifications without notice at any time.

Maxim Integrated Products, 120 San Gabriel Drive, Sunnyvale, CA 94086 408-737-7600 _____ 15