

Description

- Six sizes of shielded drum core inductors with low profiles (as low as 1.0mm) and high power density
- Inductance range from .47uH to 1000uH
- Current range from 6.00 to 0.088 Amps
- Ferrite shielded, low EMI
- Ferrite core material



Applications

- Digital cameras, CD players, cellular phones, and PDAs
- PCMCIA cards
- GPS systems

Environmental Data

- Storage temperature range: -40°C to +125°C
- Operating ambient temperature range: -40°C to +85°C (range is application specific). Temperature rise is approximately 40°C at rated rms current
- Solder reflow temperature: +260°C max. for 10 seconds max.

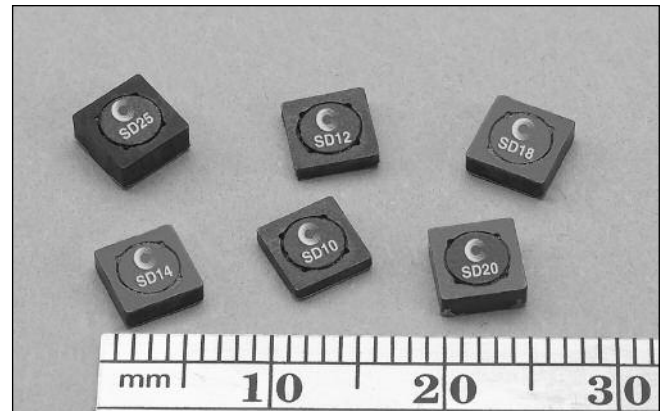

Packaging

- Supplied in tape and reel packaging, 3800 (SD10, SD12, SD14 and SD18), 2900 (SD20 and SD25) per reel

| Part Number | Rated Inductance (µH) | OCL (1) +/-20% (µH) | Part Marking | Irms (2) Amperes | Isat (3) Amperes | DCR (4) (Ω) Typ. | Volt u-sec Typ. |
|-------------|-----------------------|---------------------|--------------|------------------|------------------|------------------|-----------------|
| SD10-R47-R | 0.470 | 0.453 | A | 2.59 | 3.54 | 0.0249 | 2.1 |
| SD10-1R0-R | 1.00 | 1.119 | B | 1.93 | 2.25 | 0.0448 | 3.3 |
| SD10-1R5-R | 1.50 | 1.563 | C | 1.60 | 1.91 | 0.0653 | 3.9 |
| SD10-2R2-R | 2.20 | 2.081 | D | 1.35 | 1.65 | 0.0912 | 4.5 |
| SD10-3R3-R | 3.30 | 3.339 | E | 1.24 | 1.31 | 0.1078 | 5.7 |
| SD10-4R7-R | 4.70 | 4.893 | F | 1.04 | 1.08 | 0.1535 | 6.9 |
| SD10-6R2-R | 6.20 | 6.743 | G | 0.94 | 0.92 | 0.218 | 8.1 |
| SD10-8R2-R | 8.20 | 8.889 | H | 0.800 | 0.800 | 0.2607 | 9.3 |
| SD10-100-R | 10.0 | 10.07 | J | 0.760 | 0.752 | 0.336 | 9.9 |
| SD10-150-R | 15.0 | 15.55 | K | 0.613 | 0.605 | 0.4429 | 12.3 |
| SD10-220-R | 22.0 | 22.21 | L | 0.498 | 0.506 | 0.6718 | 14.7 |
| SD10-330-R | 33.0 | 32.20 | M | 0.412 | 0.420 | 0.9807 | 17.7 |
| SD10-470-R | 47.0 | 46.63 | N | 0.337 | 0.349 | 1.47 | 21.3 |
| SD10-680-R | 68.0 | 70.01 | O | 0.301 | 0.285 | 1.84 | 26.1 |
| SD10-820-R | 82.0 | 83.48 | P | 0.258 | 0.261 | 2.50 | 28.5 |
| SD10-101-R | 100 | 102.0 | Q | 0.225 | 0.236 | 3.29 | 31.5 |
| SD10-151-R | 150 | 149.2 | R | 0.200 | 0.195 | 4.15 | 38.1 |
| SD10-221-R | 220 | 222.2 | S | 0.161 | 0.160 | 6.41 | 46.5 |
| SD10-331-R | 330 | 330.4 | T | 0.130 | 0.131 | 9.83 | 56.7 |
| SD10-471-R | 470 | 468.3 | U | 0.117 | 0.110 | 12.10 | 67.5 |
| SD12-R47-R | 0.470 | 0.490 | A | 3.19 | 3.86 | 0.0246 | 2.84 |
| SD12-1R2-R | 1.20 | 1.21 | B | 2.62 | 2.45 | 0.0366 | 4.47 |
| SD12-1R5-R | 1.50 | 1.69 | C | 2.19 | 2.08 | 0.0521 | 5.28 |
| SD12-2R2-R | 2.20 | 2.25 | D | 1.83 | 1.80 | 0.0747 | 6.09 |
| SD12-3R3-R | 3.30 | 3.61 | E | 1.55 | 1.42 | 0.1043 | 7.71 |
| SD12-4R7-R | 4.70 | 4.41 | F | 1.46 | 1.29 | 0.1177 | 8.53 |
| SD12-6R2-R | 6.20 | 6.25 | G | 1.21 | 1.08 | 0.1699 | 10.15 |
| SD12-8R2-R | 8.20 | 8.41 | H | 1.02 | 0.931 | 0.2399 | 11.77 |
| SD12-100-R | 10.0 | 10.89 | J | 0.938 | 0.818 | 0.2844 | 13.40 |
| SD12-150-R | 15.0 | 15.21 | K | 0.782 | 0.692 | 0.4089 | 15.83 |
| SD12-220-R | 22.0 | 22.09 | L | 0.628 | 0.574 | 0.6338 | 19.08 |
| SD12-330-R | 33.0 | 32.49 | M | 0.519 | 0.474 | 0.9289 | 23.14 |
| SD12-470-R | 47.0 | 47.61 | N | 0.428 | 0.391 | 1.37 | 28.01 |
| SD12-680-R | 68.0 | 68.89 | O | 0.341 | 0.325 | 2.16 | 33.70 |

(1) Open Circuit Inductance Test Parameters: 100kHz, 0.25Vrms, 0.0Adc.

(2) RMS current for an approximate ΔT of 40°C without core loss. It is recommended that the temperature of the part not exceed 125°C.

(3) SD10,12,18,25 Peak current for approximate 30% roll off at 20°C.
SD14 Peak current for approximate 20% roll off at 20°C.

(4) DCR limits @ 20°C.

(5) Applied Volt-Time product (V-uS) across the inductor at 100kHz necessary to generate a core loss equal to 10% of the total losses for 40°C temperature rise.

| Part Number | Rated Inductance (µH) | OCL (1) +/-20% (µH) | Part Marking | I _{rms} (2) Amperes | I _{sat} (3) Amperes | DCR (4) (Ω) Typ. | Volt u-sec Typ. |
|-------------|-----------------------|---------------------|--------------|------------------------------|------------------------------|------------------|-----------------|
| SD12-820-R | 82.0 | 82.81 | P | 0.326 | 0.297 | 2.36 | 36.95 |
| SD12-101-R | 100 | 98.0 | Q | 0.308 | 0.273 | 2.64 | 40.19 |
| SD12-151-R | 150 | 151.3 | R | 0.251 | 0.220 | 3.96 | 49.94 |
| SD12-221-R | 220 | 222.0 | S | 0.229 | 0.181 | 4.76 | 60.49 |
| SD12-331-R | 330 | 334.9 | T | 0.186 | 0.148 | 7.25 | 74.30 |
| SD12-471-R | 470 | 462.3 | U | 0.167 | 0.126 | 8.95 | 87.29 |
| SD12-681-R | 680 | 670.8 | V | 0.149 | 0.104 | 11.30 | 105 |
| SD12-821-R | 820 | 800.9 | W | 0.129 | 0.095 | 14.93 | 115 |
| SD12-102-R | 1000 | 992.3 | X | 0.121 | 0.086 | 17.20 | 128 |
| SD14-R58-R | 0.58 | 0.61 | A | 3.52 | 4.84 | 0.0220 | 3.38 |
| SD14-R87-R | 0.87 | 0.88 | B | 3.2 | 3.96 | 0.0243 | 4.13 |
| SD14-1R2-R | 1.2 | 1.23 | C | 2.7 | 3.35 | 0.0344 | 4.88 |
| SD14-1R5-R | 1.5 | 1.63 | D | 2.53 | 2.91 | 0.0390 | 5.63 |
| SD14-2R0-R | 2 | 2.09 | E | 2.37 | 2.56 | 0.0445 | 6.38 |
| SD14-2R5-R | 2.5 | 2.62 | F | 2.05 | 2.29 | 0.0595 | 7.1 |
| SD14-3R2-R | 3.2 | 3.19 | G | 1.94 | 2.08 | 0.0663 | 7.9 |
| SD14-4R5-R | 4.5 | 4.53 | H | 1.64 | 1.74 | 0.0935 | 9.4 |
| SD14-6R9-R | 6.9 | 6.98 | J | 1.35 | 1.41 | 0.1363 | 11.6 |
| SD14-8R8-R | 8.8 | 8.88 | K | 1.14 | 1.25 | 0.1913 | 13.1 |
| SD14-100-R | 10 | 9.93 | L | 1.1 | 1.18 | 0.2058 | 13.9 |
| SD14-150-R | 15 | 14.68 | M | 0.98 | 0.969 | 0.2609 | 16.9 |
| SD14-220-R | 22 | 21.93 | N | 0.806 | 0.793 | 0.3853 | 20.6 |
| SD14-330-R | 33 | 32.55 | O | 0.654 | 0.651 | 0.5852 | 25.1 |
| SD14-470-R | 47 | 47.57 | P | 0.525 | 0.538 | 0.9055 | 30.4 |
| SD14-680-R | 68 | 68.21 | Q | 0.474 | 0.449 | 1.11 | 36 |
| SD14-820-R | 82 | 83 | R | 0.408 | 0.407 | 1.50 | 40 |
| SD14-101-R | 100 | 99.25 | S | 0.386 | 0.373 | 1.68 | 44 |
| SD14-151-R | 150 | 152.4 | T | 0.315 | 0.301 | 2.52 | 54 |
| SD14-221-R | 220 | 222 | U | 0.258 | 0.249 | 3.77 | 66 |
| SD14-331-R | 330 | 335.1 | V | 0.206 | 0.203 | 5.92 | 81 |
| SD14-471-R | 470 | 471.4 | W | 0.173 | 0.171 | 8.34 | 96 |
| SD14-681-R | 680 | 683.3 | X | 0.156 | 0.142 | 10.3 | 115 |
| SD14-821-R | 820 | 823.4 | Y | 0.134 | 0.129 | 13.9 | 126 |
| SD14-102-R | 1000 | 1008 | Z | 0.126 | 0.117 | 15.8 | 140 |
| SD18-R47-R | 0.47 | 0.49 | A | 3.58 | 4.63 | 0.0201 | 2.35 |
| SD18-R82-R | 0.82 | 0.81 | B | 3.24 | 3.60 | 0.0247 | 3.02 |
| SD18-1R2-R | 1.20 | 1.21 | C | 2.97 | 2.95 | 0.0294 | 3.70 |
| SD18-1R5-R | 1.50 | 1.69 | D | 2.73 | 2.49 | 0.0345 | 4.37 |
| SD18-2R2-R | 2.20 | 2.25 | E | 2.55 | 2.16 | 0.0398 | 5.04 |
| SD18-3R3-R | 3.30 | 3.61 | F | 2.07 | 1.71 | 0.0605 | 6.38 |
| SD18-4R7-R | 4.70 | 4.41 | G | 1.77 | 1.54 | 0.0824 | 7.06 |
| SD18-6R2-R | 6.20 | 6.25 | H | 1.61 | 1.30 | 0.1000 | 8.40 |
| SD18-8R2-R | 8.20 | 8.41 | J | 1.38 | 1.12 | 0.1351 | 9.74 |
| SD18-100-R | 10.0 | 10.89 | K | 1.28 | 0.982 | 0.1584 | 11.09 |
| SD18-150-R | 15.0 | 15.21 | L | 1.06 | 0.831 | 0.2278 | 13.10 |
| SD18-220-R | 22.0 | 22.09 | M | 0.876 | 0.689 | 0.3366 | 15.79 |
| SD18-330-R | 33.0 | 32.49 | N | 0.715 | 0.568 | 0.5057 | 19.15 |
| SD18-470-R | 47.0 | 47.61 | O | 0.578 | 0.470 | 0.7732 | 23.18 |
| SD18-680-R | 68.0 | 68.89 | P | 0.514 | 0.390 | 0.9798 | 27.89 |
| SD18-820-R | 82.0 | 82.81 | Q | 0.446 | 0.356 | 1.30 | 30.58 |
| SD18-101-R | 100 | 102.01 | R | 0.419 | 0.321 | 1.47 | 33.94 |
| SD18-151-R | 150 | 151.29 | S | 0.345 | 0.263 | 2.18 | 41.33 |
| SD18-221-R | 220 | 222.01 | T | 0.296 | 0.217 | 2.95 | 50.06 |
| SD18-331-R | 330 | 334.89 | U | 0.248 | 0.177 | 4.20 | 61.49 |
| SD18-471-R | 470 | 479.61 | V | 0.201 | 0.148 | 6.39 | 73.58 |
| SD18-681-R | 680 | 681.21 | W | 0.167 | 0.124 | 9.28 | 87.70 |
| SD18-821-R | 820 | 823.69 | X | 0.145 | 0.113 | 12.35 | 96.43 |
| SD18-102-R | 1000 | 1004 | Y | 0.136 | 0.102 | 14.01 | 107 |

(1) Open Circuit Inductance Test Parameters: 100KHz, 0.25Vrms, 0.0Adc.
(2) RMS current for an approximate ΔT of 40°C without core loss. It is recommended that the temperature of the part not exceed 125°C.
(3) SD10,12,18,25 Peak current for approximate 30% roll off at 20°C.
SD14 Peak current for approximate 20% roll off at 20°C.

(4) DCR limits @ 20°C.
5) Applied Volt-Time product (V-uS) across the inductor at 100KHz necessary to generate a core loss equal to 10% of the total losses for 40°C temperature rise.

| Part Number | Rated Inductance (µH) | OCL (1) +/-20% (µH) | Part Marking | I _{rms} (2) Amperes | I _{sat} (3) Amperes | DCR (4) (Ω) Typ. | Volt u-sec Typ. |
|-------------|-----------------------|---------------------|--------------|------------------------------|------------------------------|------------------|-----------------|
| SD20-R47-R | 0.47 | 0.490 | A | 3.59 | 4.00 | 0.0200 | 2.28 |
| SD20-1R2-R | 1.20 | 1.21 | B | 3.07 | 2.55 | 0.0275 | 3.58 |
| SD20-1R5-R | 1.50 | 1.69 | C | 2.88 | 2.15 | 0.0312 | 4.23 |
| SD20-2R2-R | 2.20 | 2.25 | D | 2.45 | 1.87 | 0.0429 | 4.88 |
| SD20-3R3-R | 3.30 | 3.61 | E | 2.17 | 1.47 | 0.0547 | 6.18 |
| SD20-4R7-R | 4.70 | 4.41 | F | 2.05 | 1.33 | 0.0612 | 6.83 |
| SD20-6R2-R | 6.20 | 6.25 | G | 1.89 | 1.12 | 0.0720 | 8.13 |
| SD20-8R2-R | 8.20 | 8.41 | H | 1.61 | 0.966 | 0.1000 | 9.43 |
| SD20-100-R | 10.0 | 9.61 | J | 1.53 | 0.903 | 0.1100 | 10.08 |
| SD20-150-R | 15.0 | 15.21 | K | 1.25 | 0.718 | 0.1655 | 12.68 |
| SD20-220-R | 22.0 | 22.09 | L | 1.12 | 0.596 | 0.2053 | 15.28 |
| SD20-330-R | 33.0 | 32.49 | M | 0.913 | 0.491 | 0.3100 | 18.53 |
| SD20-470-R | 47.0 | 47.61 | N | 0.745 | 0.406 | 0.4650 | 22.43 |
| SD20-680-R | 68.0 | 68.89 | O | 0.610 | 0.337 | 0.6947 | 26.98 |
| SD20-820-R | 82.0 | 82.81 | P | 0.576 | 0.308 | 0.7785 | 29.58 |
| SD20-101-R | 100 | 98.01 | Q | 0.495 | 0.283 | 1.06 | 32.18 |
| SD20-151-R | 150 | 151.3 | R | 0.435 | 0.228 | 1.37 | 39.98 |
| SD20-221-R | 220 | 222.0 | S | 0.356 | 0.188 | 2.04 | 48.43 |
| SD20-331-R | 330 | 327.6 | T | 0.294 | 0.155 | 2.99 | 58.83 |
| SD20-471-R | 470 | 470.9 | U | 0.263 | 0.129 | 3.74 | 70.53 |
| SD20-681-R | 680 | 681.2 | V | 0.216 | 0.107 | 5.56 | 84.83 |
| SD20-821-R | 820 | 823.7 | W | 0.204 | 0.098 | 6.22 | 93.28 |
| SD20-102-R | 1000 | 1004.9 | X | 0.172 | 0.088 | 8.73 | 103 |
| SD25-R47-R | 0.47 | 0.466 | A | 3.88 | 6.00 | 0.0177 | 2.13 |
| SD25-R82-R | 0.82 | 0.770 | B | 3.58 | 4.67 | 0.0208 | 2.74 |
| SD25-1R2-R | 1.20 | 1.15 | C | 3.33 | 3.81 | 0.0240 | 3.34 |
| SD25-1R5-R | 1.50 | 1.61 | D | 3.12 | 3.23 | 0.0274 | 3.95 |
| SD25-2R2-R | 2.20 | 2.14 | E | 2.93 | 2.80 | 0.0311 | 4.56 |
| SD25-3R3-R | 3.30 | 3.43 | F | 2.64 | 2.21 | 0.0384 | 5.78 |
| SD25-4R7-R | 4.70 | 5.03 | G | 2.39 | 1.83 | 0.0467 | 6.99 |
| SD25-6R8-R | 6.80 | 6.93 | H | 2.19 | 1.56 | 0.0556 | 8.21 |
| SD25-8R2-R | 8.20 | 7.99 | J | 1.92 | 1.45 | 0.0724 | 8.82 |
| SD25-100-R | 10.0 | 10.35 | K | 1.80 | 1.27 | 0.0824 | 10.03 |
| SD25-150-R | 15.0 | 14.45 | L | 1.67 | 1.08 | 0.0956 | 11.86 |
| SD25-220-R | 22.0 | 22.81 | M | 1.34 | 0.857 | 0.1478 | 14.90 |
| SD25-330-R | 33.0 | 33.07 | N | 1.11 | 0.711 | 0.2149 | 17.94 |
| SD25-470-R | 47.0 | 47.89 | O | 0.919 | 0.592 | 0.3156 | 21.58 |
| SD25-680-R | 68.0 | 68.64 | P | 0.741 | 0.482 | 0.4850 | 25.84 |
| SD25-820-R | 82.0 | 82.17 | Q | 0.713 | 0.441 | 0.5242 | 28.27 |
| SD25-101-R | 100 | 100.79 | R | 0.670 | 0.398 | 0.5937 | 31.31 |
| SD25-151-R | 150 | 148.4 | S | 0.553 | 0.328 | 0.8723 | 38.00 |
| SD25-221-R | 220 | 222.4 | T | 0.446 | 0.268 | 1.34 | 46.51 |
| SD25-331-R | 330 | 332.2 | U | 0.359 | 0.219 | 2.07 | 56.85 |
| SD25-471-R | 470 | 472.4 | V | 0.293 | 0.184 | 3.10 | 67.79 |
| SD25-681-R | 680 | 677.2 | W | 0.262 | 0.154 | 3.88 | 81.17 |
| SD25-821-R | 820 | 826.7 | X | 0.230 | 0.139 | 5.04 | 89.68 |
| SD25-102-R | 1000 | 1003.4 | Y | 0.216 | 0.126 | 5.70 | 98.80 |

(1) Open Circuit Inductance Test Parameters: 100KHz, 0.25Vrms, 0.0Adc.
 (2) RMS current for an approximate ΔT of 40°C without core loss. It is recommended that the temperature of the part not exceed 125°C.
 (3) SD10,12,18,25 Peak current for approximate 30% roll off at 20°C.
 SD14 Peak current for approximate 20% roll off at 20°C.

(4) DCR limits @ 20°C.
 (5) Applied Volt-Time product (V-uS) across the inductor at 100kHz necessary to generate a core loss equal to 10% of the total losses for 40°C temperature rise.

Mechanical Diagrams

SD Series

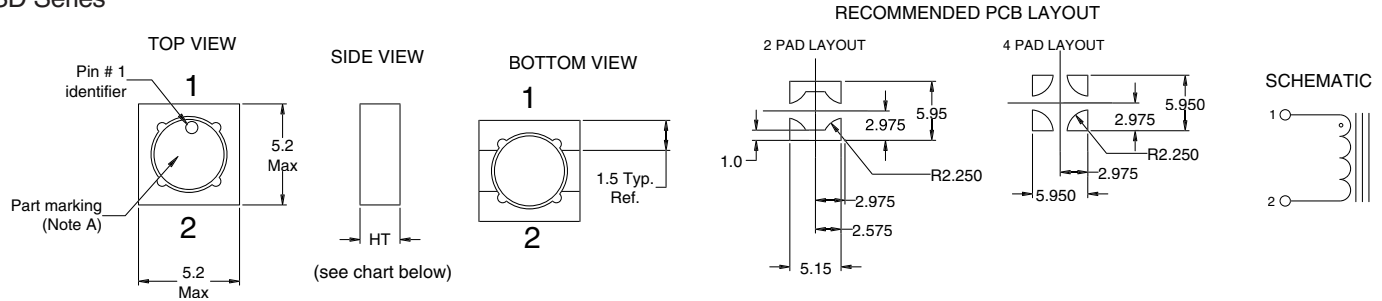

| Series | HT |
|--------|------------|
| SD10 | 1.0mm max |
| SD12 | 1.2mm max |
| SD14 | 1.45mm max |
| SD18 | 1.8mm max |
| SD20 | 2.0mm max |
| SD25 | 2.5mm max |

A) Part Marking: Line 1: (1st digit indicates the inductance value per part marking designator in chart above)
(2nd digit is a bi-weekly production date code)
(3rd digit is the last digit of the year produced)
Line 2: XX (indicates the product size code)

Packaging Information

SD10 Series

Ao=5.45mm
Bo=5.45mm
Ko=1.20mm

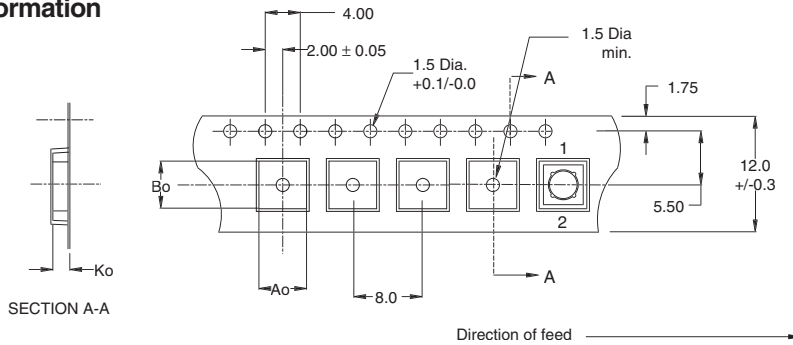

ACTUAL SIZE
SD10

Parts packaged on 13" Diameter reel,
3,800 parts per reel.

SD12/14/18 Series

Ao=5.45mm
Bo=5.45mm
Ko=2.00mm

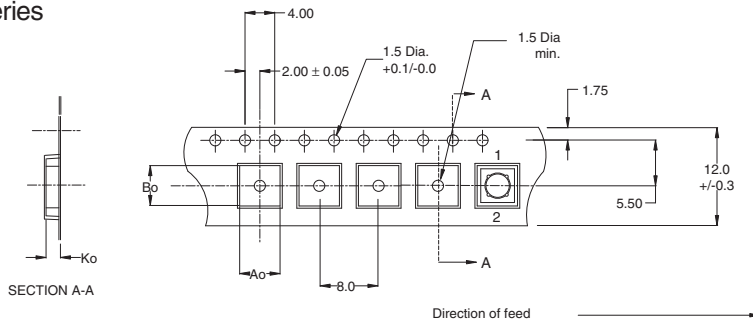

ACTUAL SIZE
SD12

ACTUAL SIZE
SD14

ACTUAL SIZE
SD18

Parts packaged on 13" Diameter reel,
3,800 parts per reel.

SD20/25 Series

Ao=5.45mm
Bo=5.45mm
Ko=2.70mm

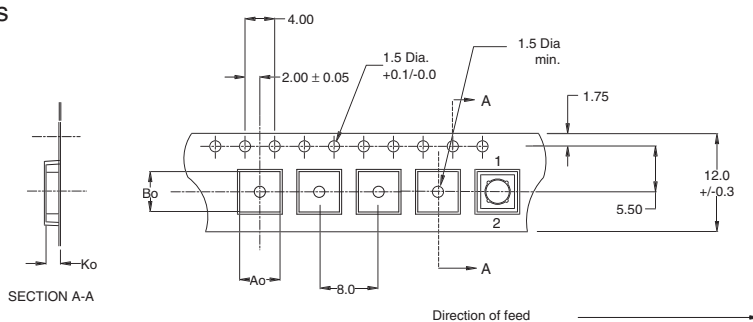

ACTUAL SIZE
SD20

ACTUAL SIZE
SD25

Parts packaged on 13" Diameter reel,
2,900 parts per reel.

Dimensions are in millimeters.

DC Current vs. Temperature

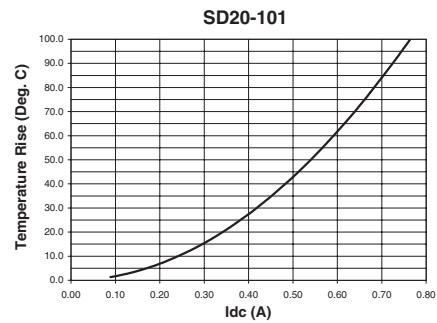
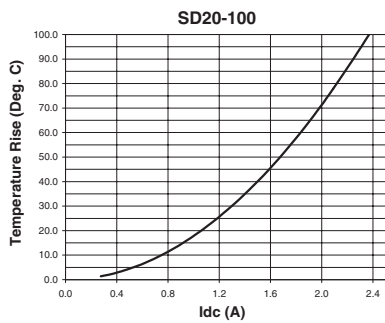
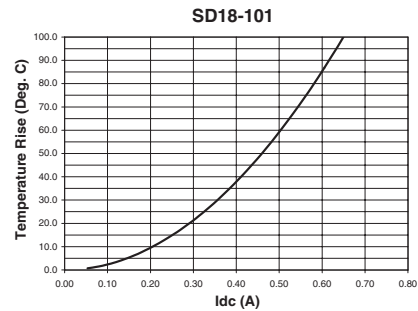
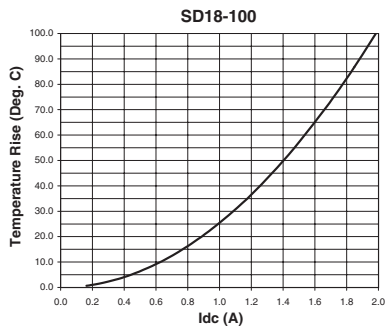
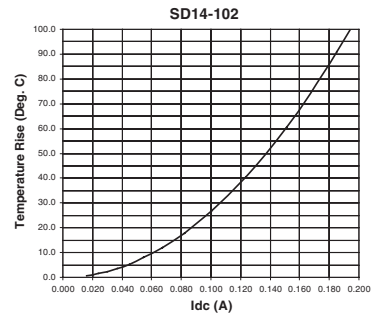
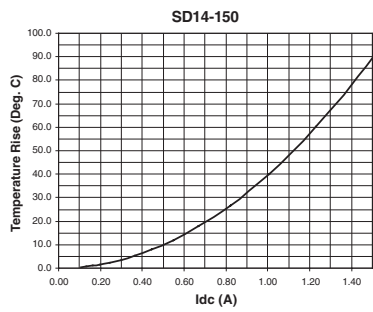
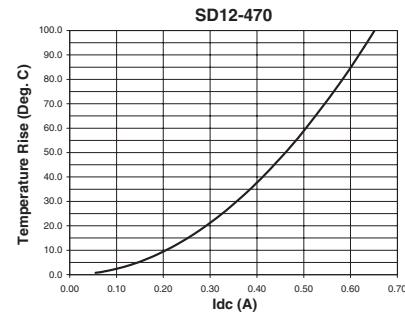
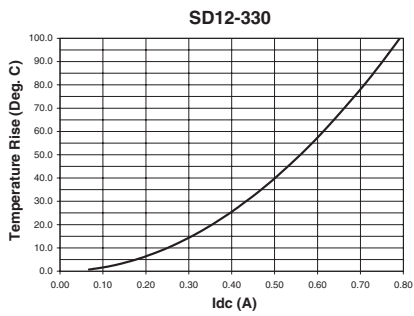
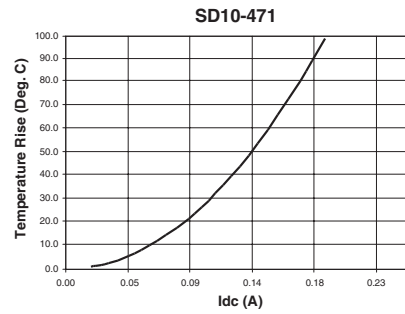
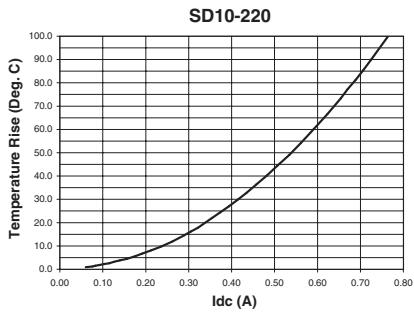

DC Current vs. Temperature

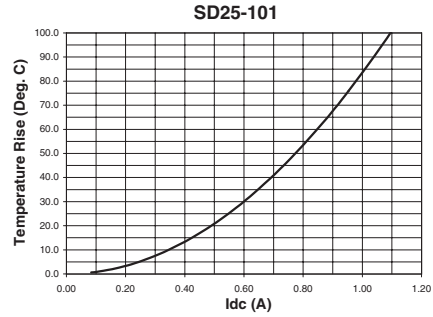
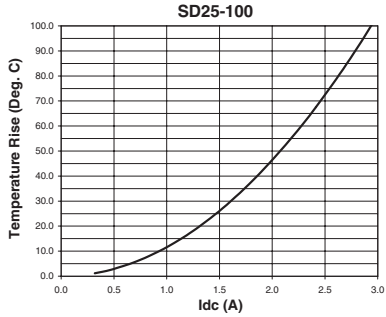

Inductance Characteristics

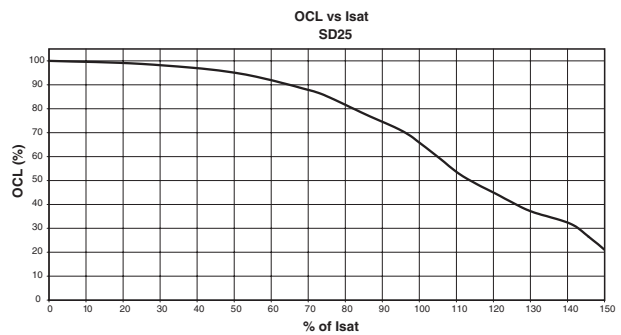
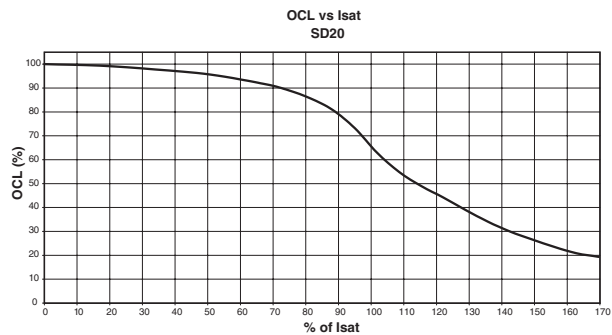
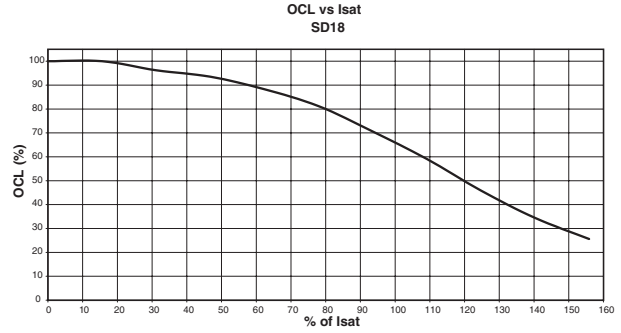
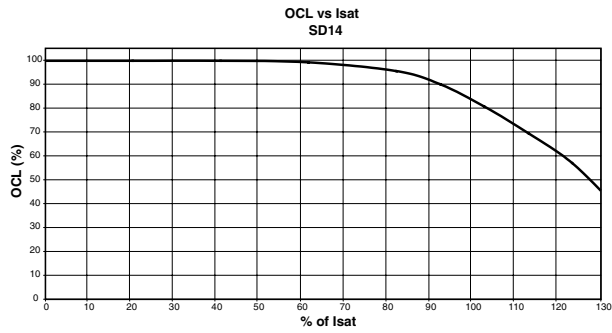
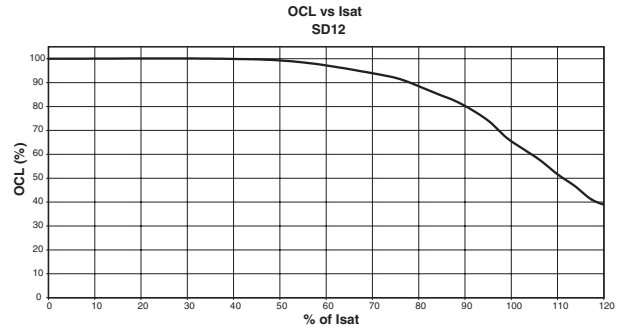
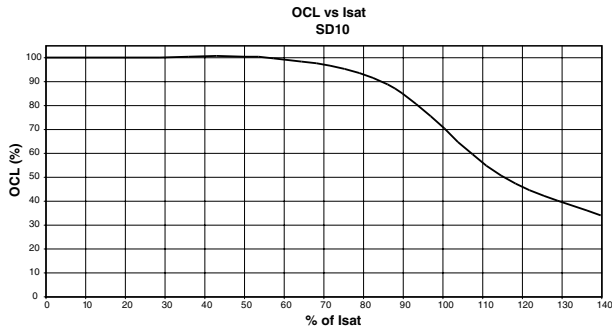

Core Loss

