

## General Description

The MAX477 is a  $\pm 5V$  wide-bandwidth, fast-settling, unity-gain-stable op amp featuring low noise, low differential gain and phase errors, high slew rate, high precision, and high output current. The MAX477's architecture uses a standard voltage-feedback topology that can be configured into any desired gain setting, as with other general-purpose op amps.

Unlike high-speed amplifiers using current-mode feedback architectures, the MAX477 has a unique input stage that combines the benefits of the voltage-feedback design (flexibility in choice of feedback resistor, two high-impedance inputs) with those of the current-feedback design (high slew rate and full-power bandwidth). It also has the precision of voltage-feedback amplifiers, characterized by low input-offset voltage and bias current, low noise, and high common-mode and power-supply rejection.

The MAX477 is ideally suited for driving  $50\Omega$  or  $75\Omega$  loads. Available in DIP, SO, space-saving  $\mu$ MAX, and SOT23 packages.

## Applications

Broadcast and High-Definition TV Systems  
Video Switching and Routing  
Communications  
Medical Imaging  
Precision DAC/ADC Buffer

## Typical Operating Circuit

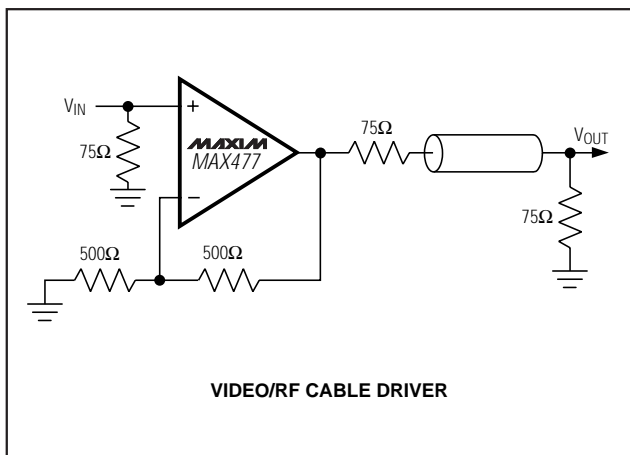

## Features

- ◆ **High Speed:**
  - 300MHz -3dB Bandwidth ( $A_V = +1$ )**
  - 200MHz Full-Power Bandwidth ( $A_V = +1, V_O = 2V_{p-p}$ )**
  - 1100V/ $\mu$ s Slew Rate**
  - 130MHz 0.1dB Gain Flatness**
- ◆ **Drives 100pF Capacitive Loads Without Oscillation**
- ◆ **Low Differential Phase/Gain Error: 0.01°/0.01%**
- ◆ **8mA Quiescent Current**
- ◆ **Low Input-Referred Voltage Noise:  $5nV/\sqrt{Hz}$**
- ◆ **Low Input-Referred Current Noise:  $2pA/\sqrt{Hz}$**
- ◆ **Low Input Offset Voltage: 0.5mV**
- ◆ **8000V ESD Protection**
- ◆ **Voltage-Feedback Topology for Simple Design Configurations**
- ◆ **Short-Circuit Protected**
- ◆ **Available in Space-Saving SOT23 Package**

## Ordering Information

PART	TEMP. RANGE	PIN-PACKAGE	SOT TOP MARK
MAX477EPA	-40°C to +85°C	8 Plastic DIP	—
MAX477ESA	-40°C to +85°C	8 SO	—
MAX477EUA	-40°C to +85°C	8 $\mu$ MAX	—
MAX477EUK-T	-40°C to +85°C	5 SOT23	ABYW
MAX477MJA	-55°C to +125°C	8 CERDIP	—

## Pin Configuration

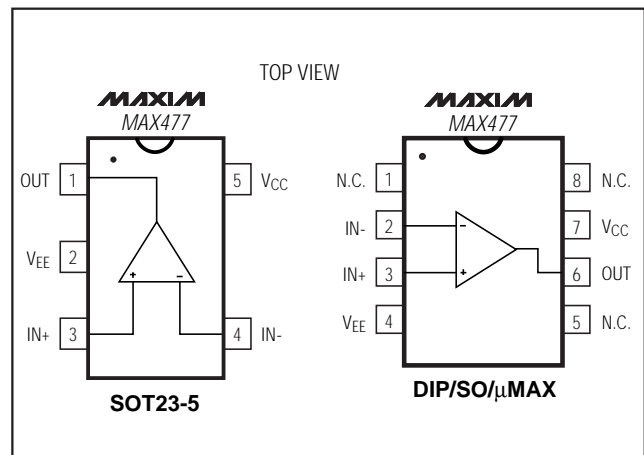

# 300MHz High-Speed Op Amp

MAX477

## ABSOLUTE MAXIMUM RATINGS

Supply Voltage ( $V_{CC}$ to $V_{EE}$ ).....	12V	CERDIP (derate 8.00mW/°C above +70°C).....	640mW
Differential Input Voltage.....( $V_{CC} + 0.3V$ ) to ( $V_{EE} - 0.3V$ )		SOT23 (derate 7.1mW/°C above +70°C).....	571mW
Common-Mode Input Voltage.....( $V_{CC} + 0.3V$ ) to ( $V_{EE} - 0.3V$ )		Operating Temperature Ranges	
Output Short-Circuit Duration to GND.....	Continuous	MAX477E_A.....	-40°C to +85°C
Continuous Power Dissipation ( $T_A = +70^\circ\text{C}$ )		MAX477EUK.....	-40°C to +85°C
Plastic DIP (derate 9.09mW/°C above +70°C).....	727mW	MAX477MJA.....	-55°C to +125°C
SO (derate 5.88mW/°C above +70°C).....	471mW	Storage Temperature Range.....	-65°C to +160°C
$\mu$ MAX (derate 4.1mW/°C above +70°C).....	330mW	Lead Temperature (soldering, 10sec).....	+300°C

Stresses beyond those listed under "Absolute Maximum Ratings" may cause permanent damage to the device. These are stress ratings only, and functional operation of the device at these or any other conditions beyond those indicated in the operational sections of the specifications is not implied. Exposure to absolute maximum rating conditions for extended periods may affect device reliability.

## DC ELECTRICAL CHARACTERISTICS

( $V_{CC} = +5V$ ,  $V_{EE} = -5V$ ,  $V_{OUT} = 0V$ ,  $R_L = \infty$ ,  $T_A = T_{MIN}$  to  $T_{MAX}$ , unless otherwise noted. Typical values are at  $T_A = +25^\circ\text{C}$ .) (Note 1)

PARAMETER	SYMBOL	CONDITIONS		MIN	TYP	MAX	UNITS	
Input Offset Voltage	$V_{OS}$	MAX477ESA/EPA/EUA/MJA	$T_A = +25^\circ\text{C}$		0.5	2.0	mV	
		MAX477EUK			0.5	2.0		
		MAX477ESA/EPA/EUA/MJA	$T_A = T_{MIN}$ to $T_{MAX}$			3.0		mV
		MAX477EUK				5.0		
Input Offset-Voltage Drift	$TCV_{OS}$			2			$\mu\text{V}/^\circ\text{C}$	
Input Bias Current	$I_B$	$T_A = +25^\circ\text{C}$		1	3		$\mu\text{A}$	
		$T_A = T_{MIN}$ to $T_{MAX}$				5.0		
Input Offset Current	$I_{OS}$	$T_A = +25^\circ\text{C}$		0.2	1.0		$\mu\text{A}$	
		$T_A = T_{MIN}$ to $T_{MAX}$				2.0		
Differential-Mode Input Resistance	$R_{IN(DM)}$	Either input		1			$\text{M}\Omega$	
Common-Mode Input Voltage Range	$V_{CM}$	$T_A = +25^\circ\text{C}$		$\pm 3.0$	$\pm 3.5$		V	
		$T_A = T_{MIN}$ to $T_{MAX}$		$\pm 2.5$				
Common-Mode Rejection Ratio	CMRR	$T_A = +25^\circ\text{C}$	$V_{CM} = \pm 3V$	70	90		dB	
		$T_A = T_{MIN}$ to $T_{MAX}$	$V_{CM} = \pm 2.5V$	60				
Power-Supply Rejection Ratio	PSRR	$V_S = \pm 4.5V$ to $\pm 5.5V$		70	85		dB	
Open-Loop Voltage Gain	$A_{VOL}$	$V_{OUT} = \pm 2.0V$ , $V_{CM} = 0V$ , $R_L = 50\Omega$	MAX477E_A/477MJA	55	65		dB	
			MAX477EUK	50	65			
Output Voltage Swing	$V_{OUT}$	$T_A = +25^\circ\text{C}$	$R_L = \infty$	$\pm 3.5$	$\pm 3.9$		V	
		$T_A = T_{MIN}$ to $T_{MAX}$	$R_L = 100\Omega$	$\pm 3.0$				
			$R_L = 50\Omega$	$\pm 2.5$				
Minimum Output Current	$I_{OUT}$	$T_A = -40^\circ\text{C}$ to $+85^\circ\text{C}$		70	100		mA	
Short-Circuit Output Current	$I_{SC}$	Short to ground			150		mA	
Open-Loop Output Resistance	$R_{OUT}$	$V_{OUT} = 0$ , $f = \text{DC}$			0.1		$\Omega$	
Quiescent Supply Current	$I_{SY}$	$T_A = +25^\circ\text{C}$		8	10		mA	
		MAX477E_-, $T_A = T_{MIN}$ to $T_{MAX}$				12	mA	
		MAX477MJA, $T_A = T_{MIN}$ to $T_{MAX}$				14		

# 300MHz High-Speed Op Amp

MAX477

## AC ELECTRICAL CHARACTERISTICS

( $V_{CC} = +5V$ ,  $V_{EE} = -5V$ ,  $R_L = 100\Omega$ ,  $A_{VCL} = +1$ ,  $T_A = +25^\circ C$ , unless otherwise noted.)

PARAMETER	SYMBOL	CONDITIONS	MIN	TYP	MAX	UNITS
Small-Signal, -3dB Bandwidth (Note 2)	BW <sub>-3dB</sub>	$V_{OUT} \leq 0.1V_{p-p}$	220	300		MHz
Small-Signal, $\pm 0.1dB$ Gain Flatness (Note 2)	BW <sub>0.1dB</sub>	$V_{OUT} \leq 0.1V_{p-p}$	30	130		MHz
Full-Power Bandwidth	FPBW	$V_{OUT} = 2V_{p-p}$		200		MHz
Slew Rate (Note 2)	SR	$V_{OUT} = \pm 2V_{p-p}$	700	1100		V/ $\mu s$
Settling Time	$t_S$	$V_{OUT} = 2V$ Step	to 0.1%	10		ns
			to 0.01%	12		
Rise Time, Fall Time	$t_R, t_F$	$V_{OUT} = 2V$ Step		2		ns
Input Voltage Noise Density	$e_n$	$f = 10MHz$		5		nV/ $\sqrt{Hz}$
Input Current Noise Density	$i_n$	$f = 10MHz$ , either input		2		pA/ $\sqrt{Hz}$
Differential Gain (Note 3)	DG	$f = 3.58MHz$		0.01		%
Differential Phase (Note 3)	DP	$f = 3.58MHz$		0.01		degrees
Differential-Mode Input Capacitance	$C_{IN(DM)}$	Either input		1		pF
Output Impedance	$Z_{OUT}$	$f = 10MHz$		2.5		$\Omega$
Total Harmonic Distortion	THD	$f_c = 10MHz$ , $V_{OUT} = 2V_{p-p}$		-58		dB
Spurious-Free Dynamic Range	SFDR	$f = 5MHz$ , $V_{OUT} = 2V_{p-p}$		-74		dBc
Third-Order Intercept	IP3	$f = 10MHz$ , $V_{OUT} = 2V_{p-p}$		36		dBm

**Note 1:** Specifications for the MAX477EUK (SOT23 package) are 100% tested at  $T_A = +25^\circ C$ , and guaranteed by design over temperature.

**Note 2:** Maximum AC specifications are guaranteed by sample test on the MAX477ESA only.

**Note 3:** Tested with a 3.58MHz video test signal with an amplitude of 40IRE superimposed on a linear ramp (0 to 100IRE). An IRE is a unit of video-signal amplitude developed by the Institute of Radio Engineers. 140IRE = 1V.

## Typical Operating Characteristics

( $V_{CC} = +5V$ ,  $V_{EE} = -5V$ ,  $R_L = 100\Omega$ ,  $C_L = 0pF$ ,  $T_A = +25^\circ C$ , unless otherwise noted.)

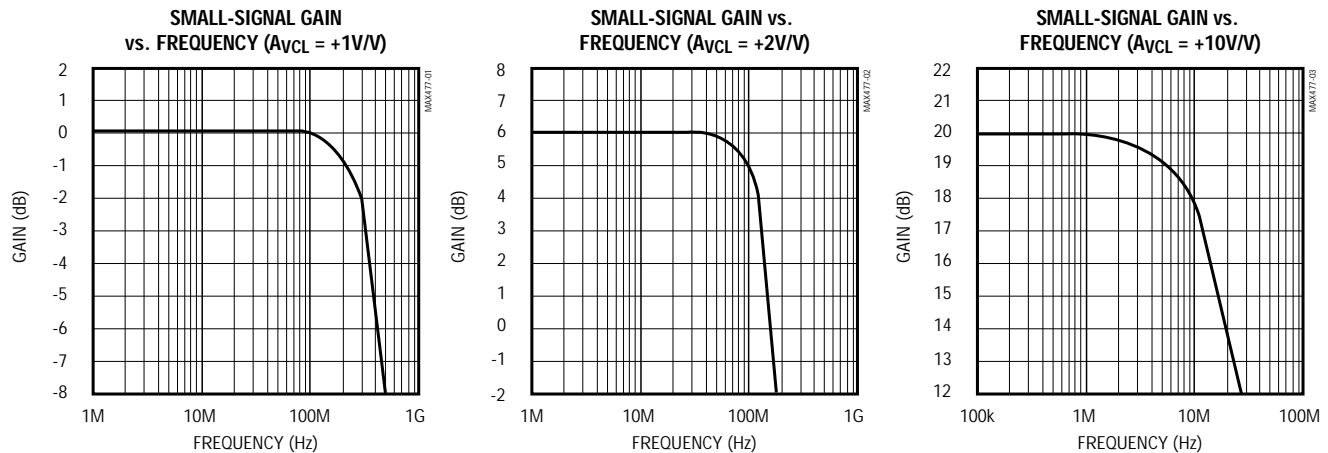

# 300MHz High-Speed Op Amp

## Typical Operating Characteristics (continued)

( $V_{CC} = +5V$ ,  $V_{EE} = -5V$ ,  $R_L = 100\Omega$ ,  $C_L = 0pF$ ,  $T_A = +25^\circ C$ , unless otherwise noted.)

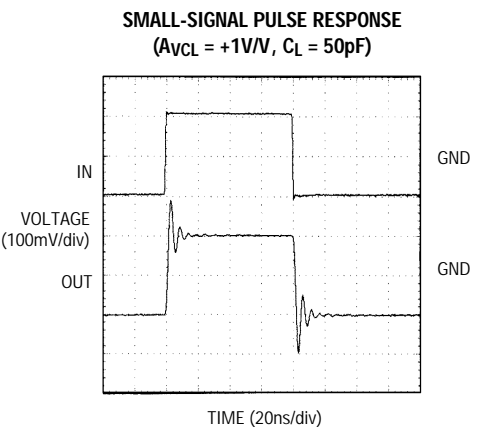
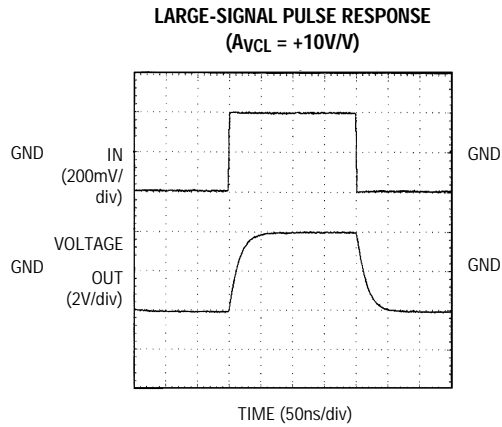
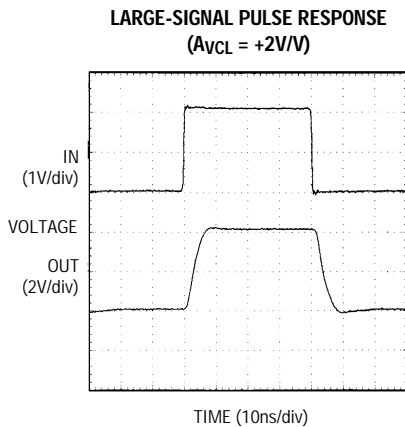
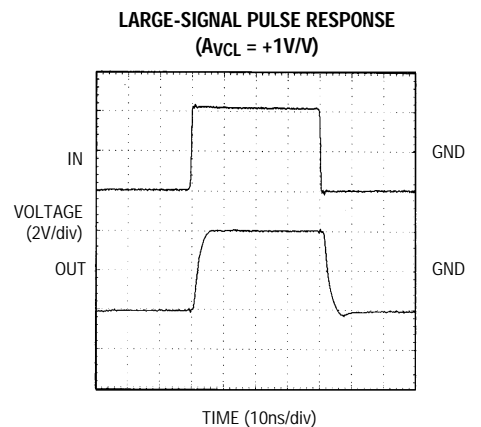
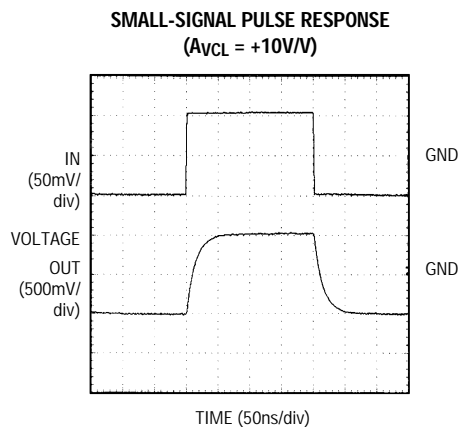
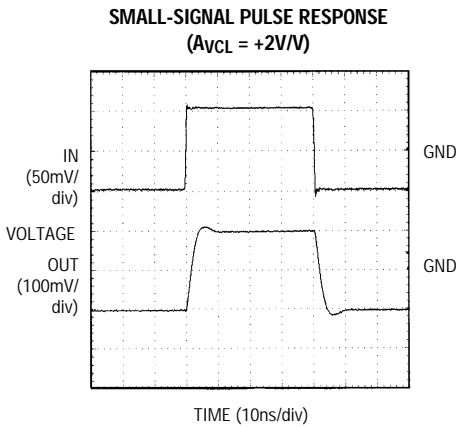
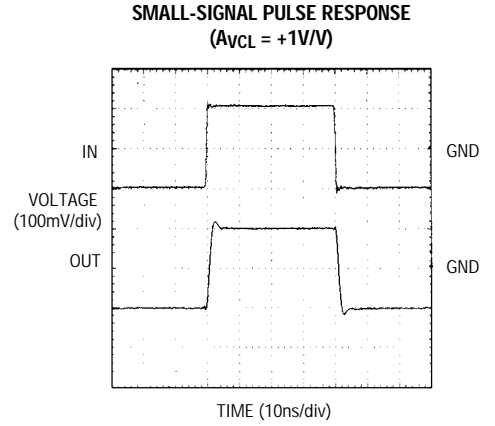
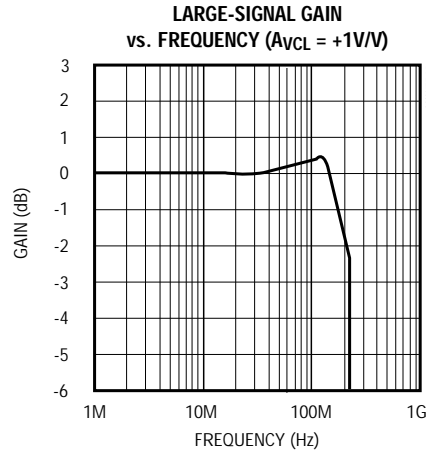
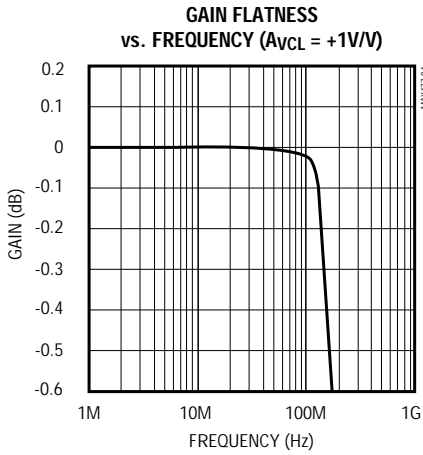

# 300MHz High-Speed Op Amp

MAX477

## Typical Operating Characteristics (continued)

( $V_{CC} = +5V$ ,  $V_{EE} = -5V$ ,  $R_L = 100\Omega$ ,  $C_L = 0pF$ ,  $T_A = +25^\circ C$ , unless otherwise noted.)

**SMALL-SIGNAL PULSE RESPONSE**  
( $A_{vCL} = +1V/V$ ,  $C_L = 100pF$ )

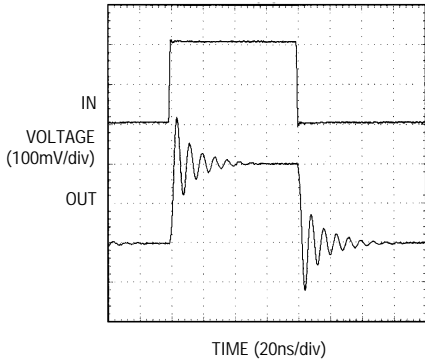

**LARGE-SIGNAL PULSE RESPONSE**  
( $A_{vCL} = +1V/V$ ,  $C_L = 50pF$ )

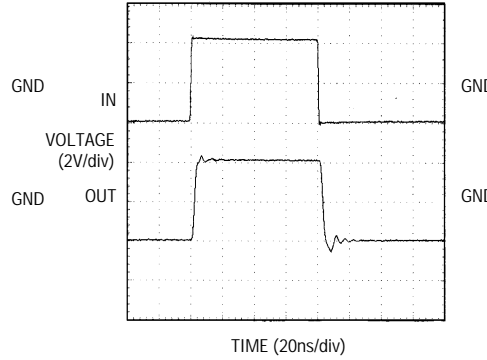

**LARGE-SIGNAL PULSE RESPONSE**  
( $A_{vCL} = +1V/V$ ,  $C_L = 100pF$ )

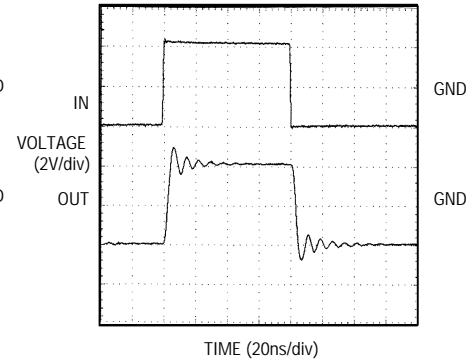

**INPUT OFFSET VOLTAGE ( $V_{OS}$ ) vs. TEMPERATURE**

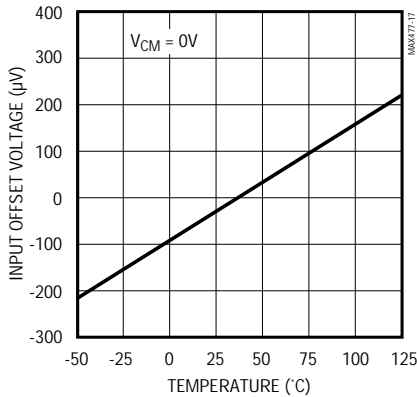

**QUIESCENT SUPPLY CURRENT ( $I_{SY}$ ) vs. TEMPERATURE**

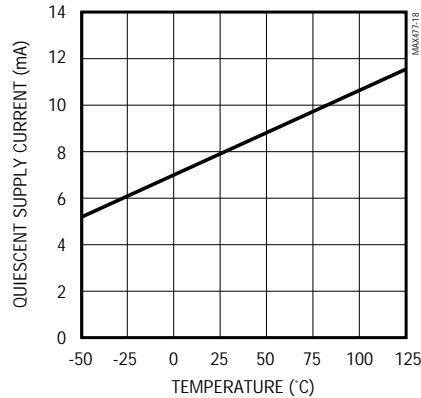

**INPUT BIAS CURRENT ( $I_B$ ) vs. TEMPERATURE**

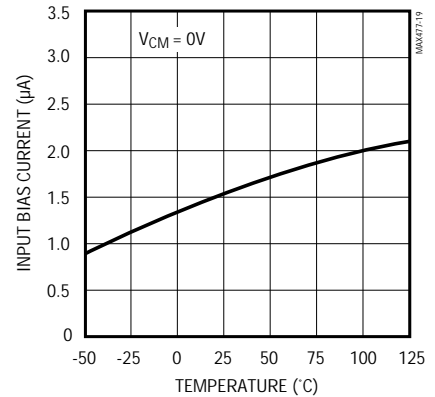

**OUTPUT VOLTAGE SWING vs. TEMPERATURE**

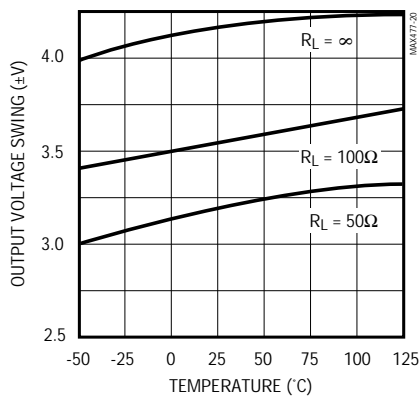

**INPUT COMMON-MODE RANGE ( $V_{CM}$ ) vs. TEMPERATURE**

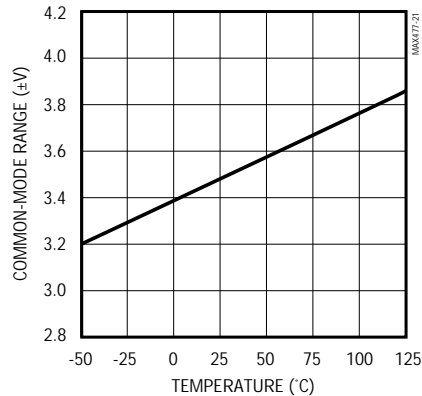

# 300MHz High-Speed Op Amp

## Typical Operating Characteristics (continued)

( $V_{CC} = +5V$ ,  $V_{EE} = -5V$ ,  $R_L = 100\Omega$ ,  $C_L = 0pF$ ,  $T_A = +25^\circ C$ , unless otherwise noted.)

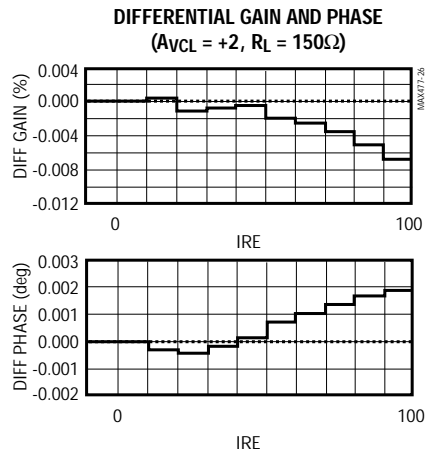
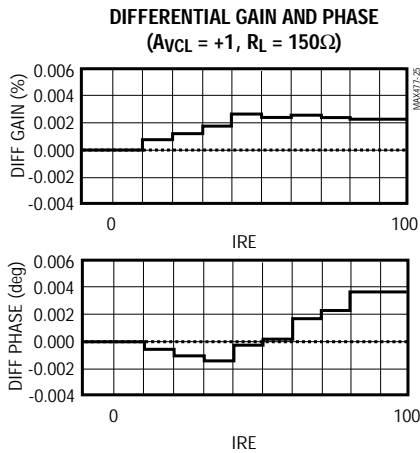
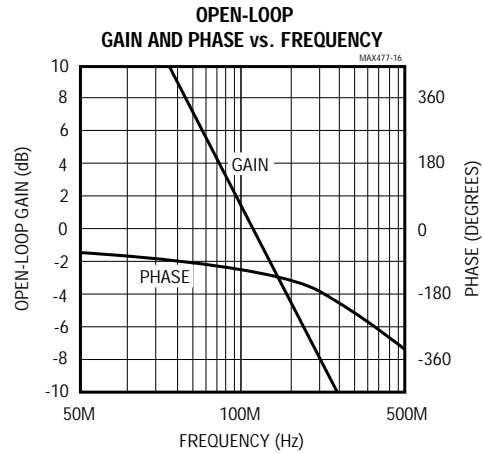
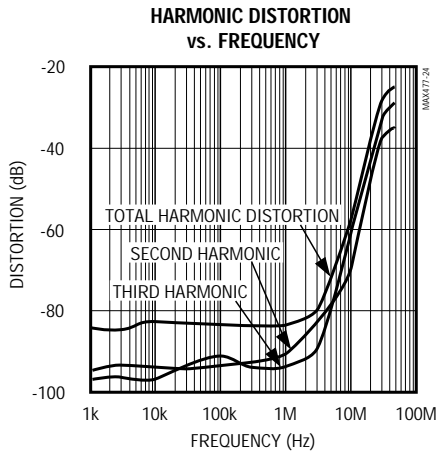
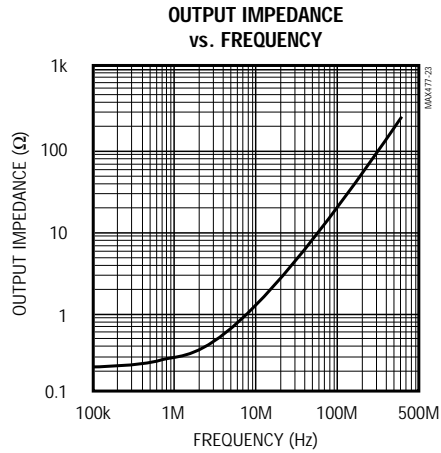
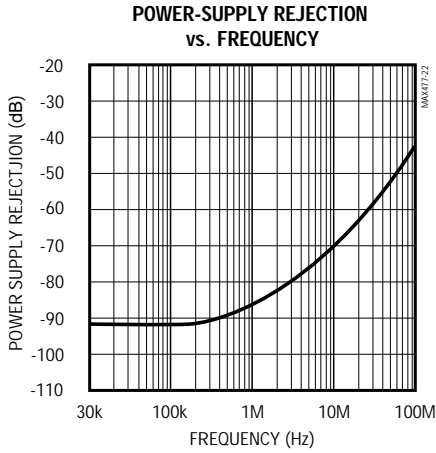

# 300MHz High-Speed Op Amp

MAX477

## Pin Description

PIN SO/ $\mu$ MAX/DIP	SOT23	NAME	FUNCTION
1, 5, 8	—	N.C.	No Connect. Not internally connected.
2	4	IN-	Inverting Input
3	3	IN+	Noninverting Input
4	2	V <sub>EE</sub>	Negative Power Supply
6	1	OUT	Amplifier Output
7	5	V <sub>CC</sub>	Positive Power Supply

## Detailed Description

The MAX477 allows the flexibility and ease of a classic voltage-feedback architecture while maintaining the high-speed benefits of current-mode feedback (CMF) amplifiers. Although the MAX477 is a voltage-feedback op amp, its internal architecture provides an 1100V/ $\mu$ s slew rate and a low 8mA supply current. CMF amplifiers offer high slew rates while maintaining low supply current, but use the feedback and load resistors as part of the amplifier's frequency compensation network. In addition, they have only one input with high impedance.

The MAX477 has speed and power specifications like those of current-feedback amplifiers, but has high input impedance at both input terminals. Like other voltage-feedback op amps, its frequency compensation is independent of the feedback and load resistors, and it exhibits a constant gain-bandwidth product. However, unlike standard voltage-feedback amplifiers, its large-signal slew rate is not limited by an internal current source, so the MAX477 exhibits a very high full-power bandwidth.

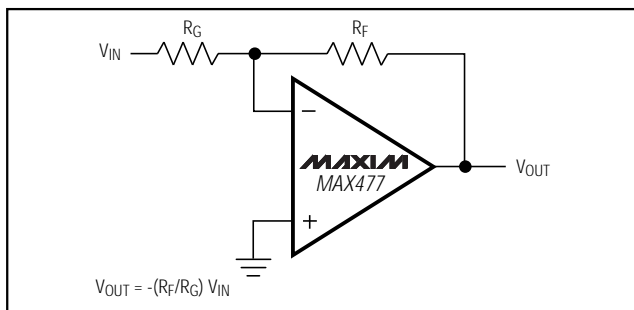

Figure 1a. Inverting Gain Configuration

### Output Short-Circuit Protection

Under short-circuit conditions, the output current is typically limited to 150mA. This is low enough that a short to ground of any duration will not cause permanent damage to the chip. However, a short to either supply will significantly increase the power dissipation and may cause permanent damage. The high output-current capability is an advantage in systems that transmit a signal to several loads. See *High-Performance Video Distribution Amplifier* in the *Applications Information* section.

## Applications Information

### Grounding, Bypassing, and PC Board Layout

To obtain the MAX477's full 300MHz bandwidth, Microstrip and Stripline techniques are recommended in most cases. To ensure the PC board does not degrade the amplifier's performance, design the board for a frequency greater than 1GHz. Even with very short traces, use these techniques at critical points, such as inputs and outputs. Whether you use a constant-impedance board or not, observe the following guidelines when designing the board:

- Do not use wire-wrap boards. They are too inductive.
- Do not use IC sockets. They increase parasitic capacitance and inductance.
- In general, surface-mount components have shorter leads and lower parasitic reactance, giving better high-frequency performance than through-hole components.
- The PC board should have at least two layers, with one side a signal layer and the other a ground plane.
- Keep signal lines as short and straight as possible. Do not make 90° turns; round all corners.
- The ground plane should be as free from voids as possible.

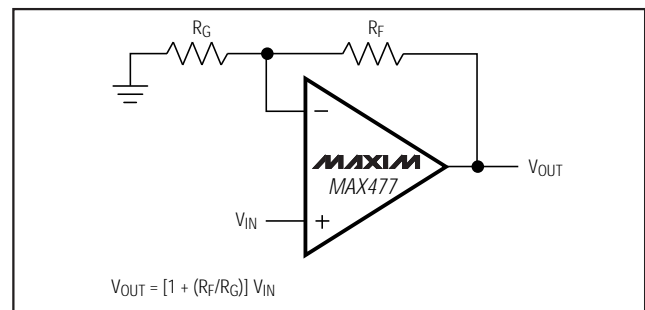

Figure 1b. Noninverting Gain Configuration

# 300MHz High-Speed Op Amp

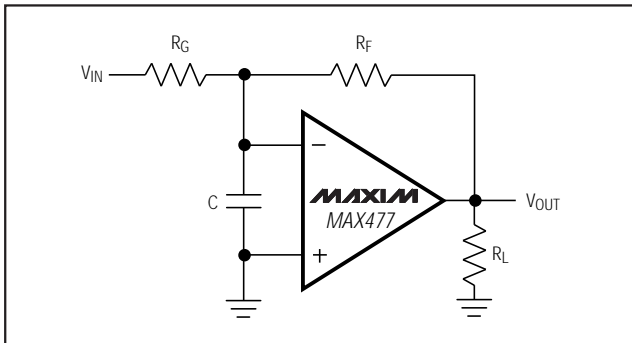

Figure 2. Effect of High-Feedback Resistor Values and Parasitic Capacitance on Bandwidth

## Setting Gain

The MAX477 can be configured as an inverting or non-inverting gain block in the same manner as any other voltage-feedback op amp. The gain is determined by the ratio of two resistors and does not affect amplifier frequency compensation. This is unlike CMF op amps, which have a limited range of feedback resistors, typically one resistor value for each gain and load setting. This is because the -3dB bandwidth of a CMF op amp is set by the feedback and load resistors. Figure 1a shows the inverting gain configuration and its gain equation, while Figure 1b shows the noninverting gain configuration.

## Choosing Resistor Values

The feedback and input resistor values are not critical in the inverting or noninverting gain configurations (as with current-feedback amplifiers). However, be sure to select resistors that are small and noninductive.

Surface-mount resistors are best for high-frequency circuits. Their material is similar to that of metal-film resistors, but to minimize inductance, it is deposited in a flat, linear manner using a thick film. Their small size and lack of leads also minimize parasitic inductance and capacitance.

The MAX477's input capacitance is approximately 1pF. In either the inverting or noninverting configuration, excess phase resulting from the pole frequency formed by  $R_f \parallel R_g$  and  $C$  can degrade amplifier phase margin and cause oscillations (Figure 2). Table 1 shows the recommended resistor combinations and measured bandwidth for several gain values.

## DC and Noise Errors

The standard voltage-feedback topology of the MAX477 allows DC error and noise calculations to be done in the usual way. The following analysis shows

Table 1. Resistor and Bandwidth Values for Various Closed-Loop Gain Configurations

GAIN (V/V)	R <sub>g</sub> (Ω)	R <sub>f</sub> (Ω)	-3dB BANDWIDTH (MHz)
+1	Open	Short	300
+2	500	500	120
+5	125	500	25
+10	50	450	12
-1	300	300	114
-2	150	300	64
-5	100	500	42
-10	50	500	23

that the MAX477's voltage-feedback architecture provides a precision amplifier with significantly lower DC errors and lower noise compared to CMF amplifiers.

1) In Figure 3, total output offset error is given by:

$$V_{OUT} = \left[ 1 + \frac{R_f}{R_g} \right] \left[ V_{OS} + I_B R_S - I_B (R_f \parallel R_g) + I_{OS} (R_S + (R_f \parallel R_g)) \right]$$

For the special case in which  $R_S$  is arranged to be equal to  $R_f \parallel R_g$ , the  $I_B$  terms cancel out. Note also, for  $I_{OS} (R_S + (R_f \parallel R_g)) \ll V_{OS}$ , the  $I_{OS}$  term also drops out of the equation for total DC error. In practice, high-speed configurations for the MAX477 necessitate the use of low-value resistors for  $R_S$ ,  $R_f$ , and  $R_g$ . In this case, the  $V_{OS}$  term is the dominant DC error source.

2) The MAX477's total input-referred noise in a closed-loop feedback configuration can be calculated by:

$$e_T = \sqrt{e_n^2 + e_R^2 + (I_n R_{EQ})^2}$$

where  $e_n$  = input-referred noise voltage of the MAX477 ( $5nV\sqrt{Hz}$ )

$i_n$  = input-referred noise current of the MAX477 ( $2pA\sqrt{Hz}$ )

$R_{EQ}$  = total equivalent source resistance at the two inputs, i.e.,  $R_{EQ} = R_S + R_f \parallel R_g$

$e_R$  = resistor noise voltage due to  $R_{EQ}$ , i.e.,

$$e_R = \sqrt{4KT R_{EQ}}$$



# 300MHz High-Speed Op Amp

MAX477

As an example, consider  $R_S = 75\Omega$ ,  $R_f = R_g = 500\Omega$ .  
Then:

$$R_{EQ} = 75\Omega + (500\Omega \parallel 500\Omega) = 325\Omega$$

$$e_R = \sqrt{4KT} \times 325 = 2.3nV/\sqrt{\text{Hz}} \text{ at } 25^\circ\text{C}$$

$$e_T = \sqrt{(5nV)^2 + (2.3nV)^2 + (2pA \times 325)^2} = 5.5nV\sqrt{\text{Hz}}$$

3) The MAX477's output-referred noise is simply total input-referred noise,  $e_T$ , multiplied by the gain factor:

$$e_{OUT} = e_T \left[ 1 + \frac{R_f}{R_g} \right]$$

In the above example, with  $e_T = 5.5nV\sqrt{\text{Hz}}$ , and assuming a signal bandwidth of 300MHz (471MHz noise bandwidth), total output noise in this bandwidth is:

$$e_{OUT} = 5.5nV \times \left[ 1 + \frac{500}{500} \right] \times \sqrt{471\text{MHz}} = 239\mu\text{VRMS}$$

Note that for both DC and noise calculations, errors are dominated by offset voltage ( $V_{OS}$ ) and input noise voltage ( $e_n$ ). For a current-mode feedback amplifier with offset and noise errors significantly higher, the calculations are very different.

### Driving Capacitive Loads

The MAX477 provides maximum AC performance with no output load capacitance. This is the case when the MAX477 is driving a correctly terminated transmission line (i.e., a back-terminated  $75\Omega$  cable). However, the MAX477 is capable of driving capacitive loads up to 100pF without oscillations, but with reduced AC performance.

Driving large capacitive loads increases the chance of oscillations in most amplifier circuits. This is especially true for circuits with high loop gain, such as voltage followers. The amplifier's output resistance and the load capacitor combine to add a pole and excess phase to the loop response. If the frequency of this pole is low enough and phase margin is degraded sufficiently, oscillations may occur.

A second problem when driving capacitive loads results from the amplifier's output impedance, which looks inductive at high frequency. This inductance forms an L-C resonant circuit with the capacitive load, which causes peaking in the frequency response and degrades the amplifier's gain margin.

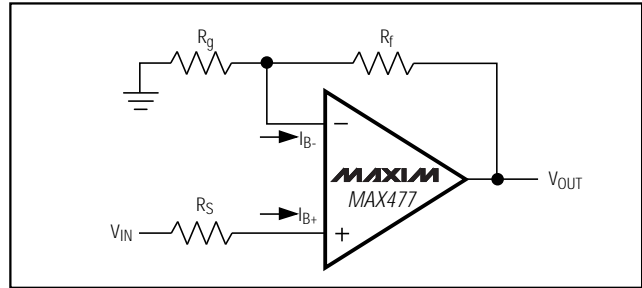

Figure 3. Output Offset Voltage

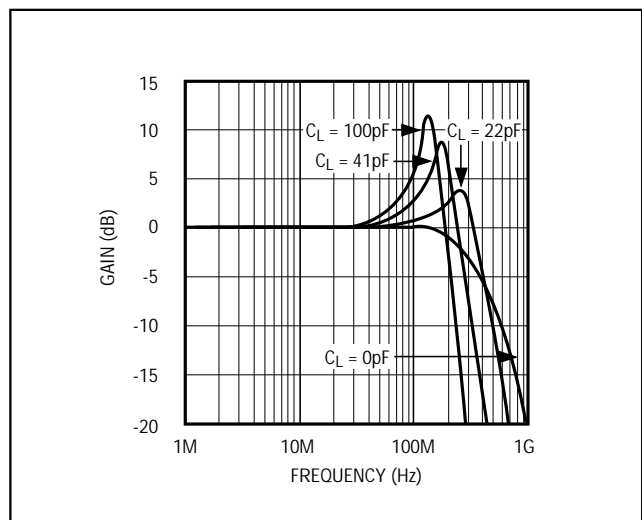

Figure 4. Effect of  $C_{LOAD}$  on Frequency Response ( $A_{VCL} = +1V/V$ )

The MAX477 drives capacitive loads up to 100pF without oscillation. However, some peaking (in the frequency domain) or ringing (in the time domain) may occur. This is shown in Figure 4 and the in the Small and Large-Signal Pulse Response graphs in the *Typical Operating Characteristics*.

To drive larger-capacitance loads or to reduce ringing, add an isolation resistor between the amplifier's output and the load, as shown in Figure 5.

The value of  $R_{ISO}$  depends on the circuit's gain and the capacitive load. Figure 6 shows the Bode plots that result when a  $20\Omega$  isolation resistor is used with a voltage follower driving a range of capacitive loads. At the higher capacitor values, the bandwidth is dominated by the RC network, formed by  $R_{ISO}$  and  $C_L$ ; the bandwidth of the amplifier itself is much higher. Note that adding an isolation resistor degrades gain accuracy. The load and isolation resistor form a divider that decreases the voltage delivered to the load.

# 300MHz High-Speed Op Amp

## Flash ADC Preamp

The MAX477's high output-drive capability and ability to drive capacitive loads make it well suited for buffering the low-impedance input of a high-speed flash ADC. With its low output impedance, the MAX477 can drive the inputs of the ADC while maintaining accuracy. Figure 7 shows a preamp for digitizing video, using the 250Msps MAX100 and the 500Msps MAX101 flash ADCs. Both of these ADCs have a 50Ω input resistance and a 1.2GHz input bandwidth.

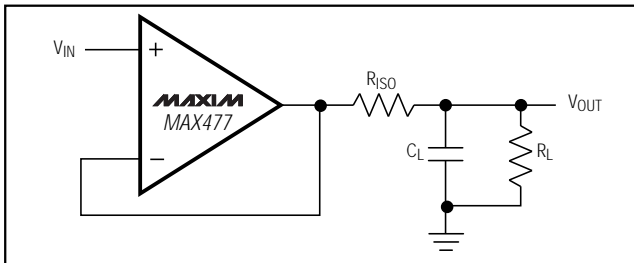

Figure 5. Capacitive-Load Driving Circuit

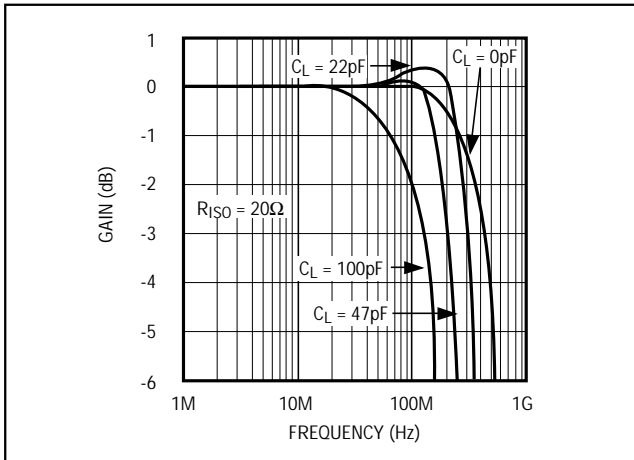

Figure 6. Effect of  $C_{LOAD}$  on Frequency Response With Isolation Resistor

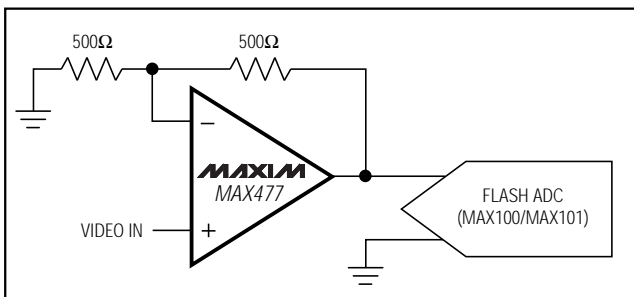

Figure 7. Preamp for Video Digitizer

## High-Performance Video Distribution Amplifier

In a gain of +2 configuration, the MAX477 makes an excellent driver for back-terminated 75Ω video coaxial cables (Figure 8). The high output-current drive allows the attachment of up to six ±2Vp-p, 150Ω loads to the MAX477 at +25°C. With the output limited to ±1Vp-p, the number of loads may double. The MAX4278 is a similar amplifier configured for a gain of +2 without the need for external gain-setting resistors. For multiple gain-of-2 video line drivers in a single package, see the MAX496/MAX497 data sheet.

## Wide-Bandwidth Bessel Filter

Two high-impedance inputs allow the MAX477 to be used in all standard active filter topologies. The filter design is straightforward because the component values can be chosen independently of op amp bias. Figure 9 shows a wide-bandwidth, second-order Bessel filter using a multiple feedback topology. The component values are chosen for a gain of +2, a -3dB bandwidth of 10MHz, and a 28ns delay. Figure 10a shows a square-wave pulse response, and Figure 10b shows the filter's frequency response and delay. Notice the flat delay in the passband, which is characteristic of the Bessel filter.

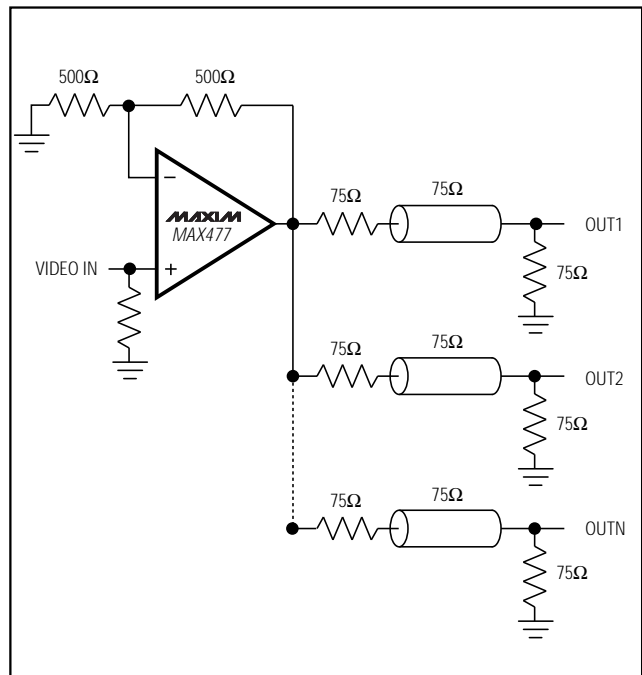

Figure 8. High-Performance Video Distribution Amplifier

# 300MHz High-Speed Op Amp

MAX477

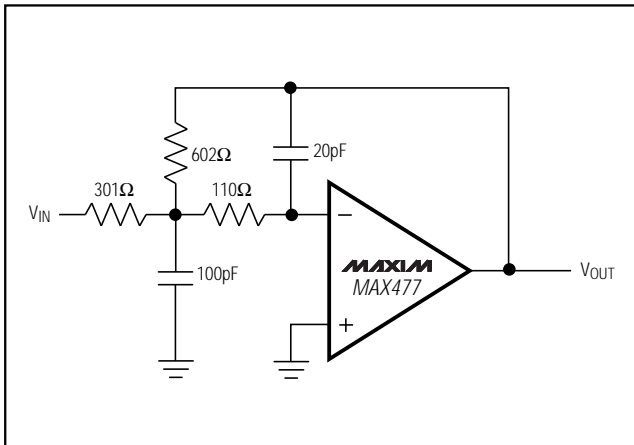

Figure 9. 8MHz Bessel Filter

## Chip Information

TRANSISTOR COUNT: 175  
SUBSTRATE CONNECTED TO VEE

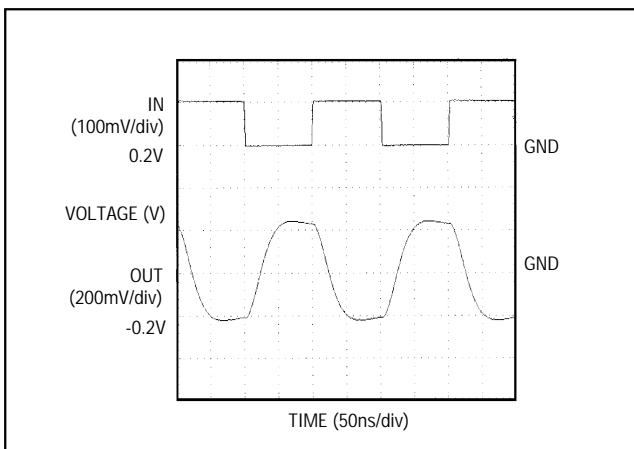

Figure 10a. 5MHz Square Wave Input

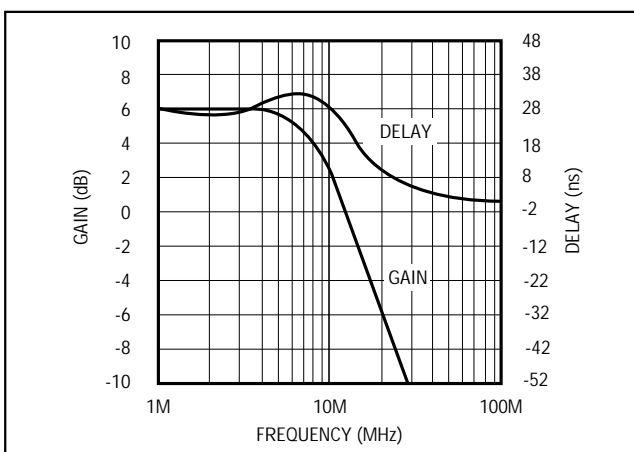

Figure 10b. Gain and Delay vs. Frequency

# 300MHz High-Speed Op Amp

MAX477

## Package Information

