



3.125Gbps XAUI Quad Cable Equalizer

General Description

The MAX3981 quad equalizer provides compensation for transmission medium losses for four “lanes” of digital NRZ data at a data rate of 3.125Gbps in one package. It is tailor-made for 10Gigabit Ethernet applications that require attenuation of noise and jitter that occur in communicating with chassis-to-chassis interconnect. In support of IEEE-802.3ae for the XAUI interface, the MAX3981 adaptively allows XAUI lanes to reach 10m (33ft) with inexpensive twin-axial cable for extended backplane applications.

The equalizer has 100Ω differential CML data inputs and outputs.

The MAX3981 is available in a 44-pin exposed-pad QFN package. The MAX3981 consumes only 700mW at 3.3V or 175mW per channel.

Applications

IEEE-802.3ae XAUI Interface (3.125Gbps)
InfiniBand (2.5Gbps)

Features

- ◆ Four Differential Digital Data “Lanes” at 3.125Gbps
- ◆ Span 10m (33ft) of Twin-Axial Cable
- ◆ Receiver Equalization Reduces Intersymbol Interference (ISI)
- ◆ Low Power, 175mW per Channel
- ◆ Standby Mode—Power-Down State
- ◆ Single 3.3V Supply
- ◆ Signal Detect

Ordering Information

PART	TEMP RANGE	PIN-PACKAGE	PACKAGE CODE
MAX3981UGH	0°C to +85°C	44 QFN	G4477-1

Pin Configuration appears at end of data sheet.

Typical Operating Circuit

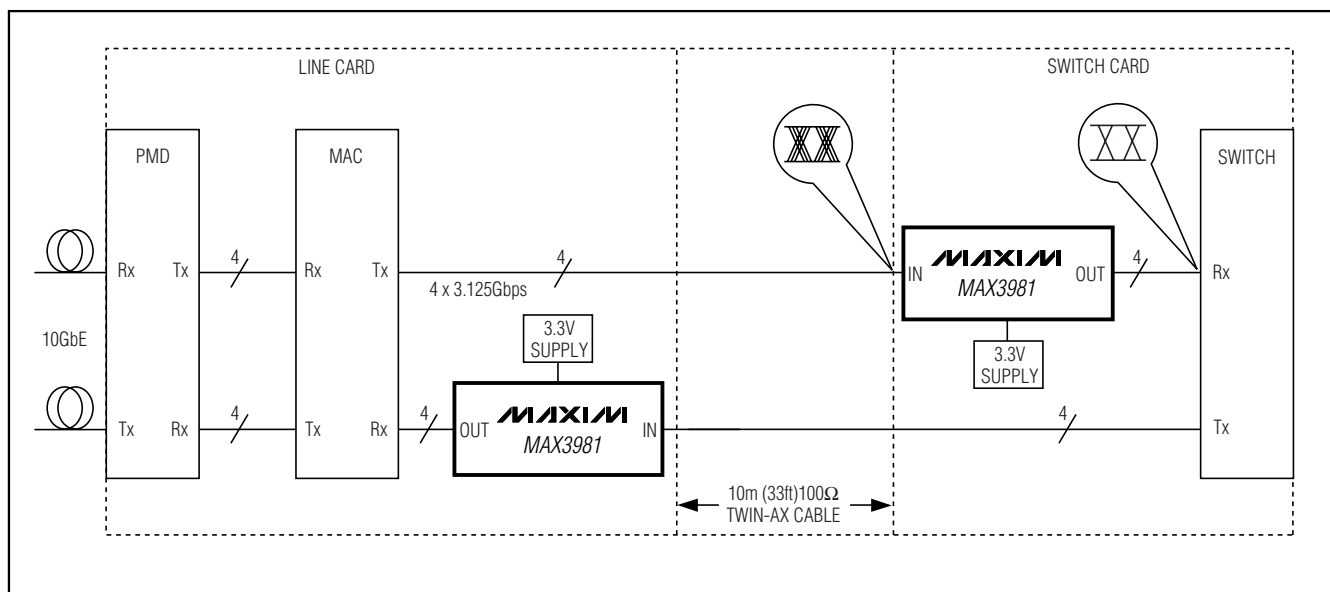

3.125Gbps XAUI Quad Cable Equalizer

ABSOLUTE MAXIMUM RATINGS

Supply Voltage, V_{CC}	-0.5V to +4.0V
Voltage at SDET	+0.5V to ($V_{CC} + 0.5V$)
Voltage at IN_{\pm}	+0.5V to ($V_{CC} + 0.5V$)
Current Out of OUT_{\pm}	-25mA to +25mA

Continuous Power Dissipation ($T_A = +85^{\circ}C$)	44-Pin QFN-EP (derate 26.3mW/ $^{\circ}C$ above +85 $^{\circ}C$)....	2105mW
Operating Ambient Temperature Range	0 $^{\circ}C$ to +85 $^{\circ}C$	
Storage Temperature Range	-55 $^{\circ}C$ to +150 $^{\circ}C$	
Lead Temperature (soldering, 10s).....	+300 $^{\circ}C$	

Stresses beyond those listed under "Absolute Maximum Ratings" may cause permanent damage to the device. These are stress ratings only, and functional operation of the device at these or any other conditions beyond those indicated in the operational sections of the specifications is not implied. Exposure to absolute maximum rating conditions for extended periods may affect device reliability.

ELECTRICAL CHARACTERISTICS

($V_{CC} = +3.0V$ to +3.6V, input data rate = 3.125Gbps, $T_A = 0^{\circ}C$ to +85 $^{\circ}C$. Typical values are at $V_{CC} = +3.3V$ and $T_A = +25^{\circ}C$, unless otherwise noted.)

PARAMETER	SYMBOL	CONDITIONS	MIN	TYP	MAX	UNITS
Supply Power		EN = TTL low			0.25	W
		EN = TTL high		0.7	0.9	
Supply Noise Tolerance		10Hz < f < 100Hz		100		mVp-p
		100Hz < f < 1MHz		40		
		1MHz < f < 2.5GHz		10		
Signal Detect Assert		Input signal level to assert SDET (Note 1)	100			mVp-p
Signal Detect Deassert		Input signal level to deassert SDET (Note 1)			30	mVp-p
Signal Detect Delay		Delay time in detecting a change in presence of a signal (Note 4)			10	μs
Latency		From input to output		0.32		ns
CML RECEIVER INPUT						
Input Voltage Swing		XAUI transmitter output measured differentially at point A, Figure 1, using K28.5 pattern (Note 4)	200		800	mVp-p
Return Loss		100MHz to 2.5GHz		12		dB
Input Resistance		Differential	80	100	120	Ω
EQUALIZATION						
Residual Jitter		Total jitter (Notes 2, 4)			0.3	UIp-p
		Deterministic jitter (Note 4)			0.2	
Random Jitter		(Note 2)		1.5		psRMS
CML TRANSMITTER OUTPUT (into 100$\Omega \pm 1\Omega$)						
Output Voltage Swing		Differential swing	550		850	mVp-p
Common-Mode Voltage				$V_{CC} - 0.3$		V
Transition Time	t_f, t_r	20% to 80% (Notes 3, 4)		60	130	ps
Differential Skew		Difference in 50% crossing between OUT_{+} and OUT_{-} (Note 4)			12	ps
Output Resistance		Single ended	40	50	60	Ω

3.125Gbps XAUI Quad Cable Equalizer

MAX3981

ELECTRICAL CHARACTERISTICS (continued)

($V_{CC} = +3.0V$ to $+3.6V$, input data rate = 3.125Gbps, $T_A = 0^{\circ}C$ to $+85^{\circ}C$. Typical values are at $V_{CC} = +3.3V$ and $T_A = +25^{\circ}C$, unless otherwise noted.)

PARAMETER	SYMBOL	CONDITIONS	MIN	TYP	MAX	UNITS
TTL CONTROL PINS						
Input High Voltage			2.0			V
Input Low Voltage					0.8	V
Input High Current					250	μA
Input Low Current					500	μA
Output High Voltage		Internal 10k Ω pullup	2.4			V
Output Low Voltage		Internal 10k Ω pullup			0.4	V

Note 1: K28.7 pattern is applied differentially at point A as shown in Figure 1.

Note 2: Total jitter does not include the signal source jitter. Total jitter (TJ) = $(14.1 \times RJ + DJ)$ where RJ is random RMS jitter and DJ is maximum deterministic jitter. Signal source is a K28.5 \pm pattern (00 1111 1010 11 0000 0101) for the deterministic jitter test and K28.7 (0011111000) or equivalent for the random jitter test. Residual jitter is that which remains after equalizing media-induced losses of the environment of Figure 1 or its equivalent. The deterministic jitter at point B must be from media-induced loss and not from clock source modulation. Jitter is measured at 0V at point C of Figure 1.

Note 3: Using K28.7 (0011111000) pattern.

Note 4: AC specifications are guaranteed by design and characterization.

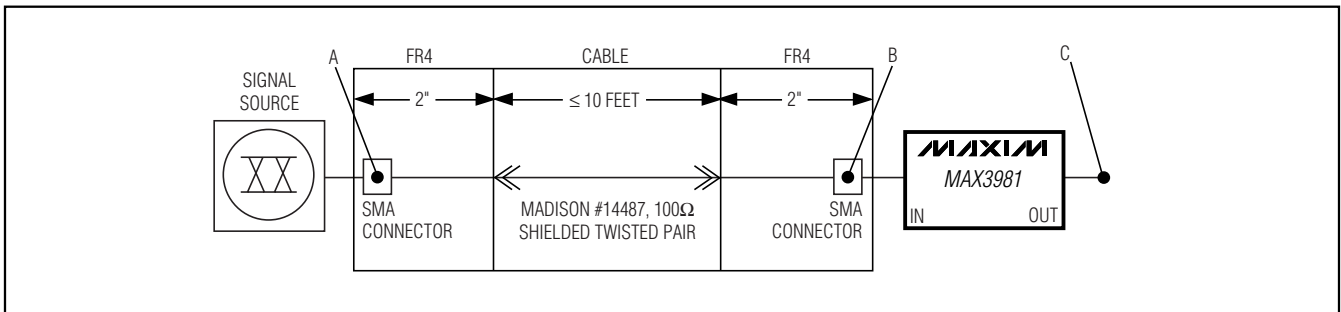

Figure 1. Test Conditions Referenced in the Electrical Characteristics Table

3.125Gbps XAUI Quad Cable Equalizer

Typical Operating Characteristics

($V_{CC} = +3.3V$, 3.125Gbps, 500mVp-p cable input with $2^7 - 1$ PRBS, $T_A = +25^\circ C$, unless otherwise noted. **Note:** Twin-axial cable used was Tensolite, Z-Skew, 100 Ω , 28AWG. Shielded twisted pair used was Madison 100 Ω , 30AWG, spec #14887.)

EQUALIZER INPUT EYE DIAGRAM AFTER 10m (33ft) OF TWIN-AXIAL CABLE

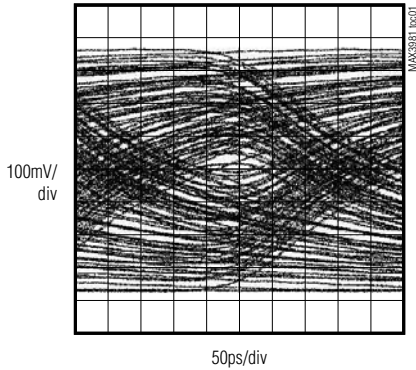

EQUALIZER OUTPUT EYE DIAGRAM AFTER 10m (33ft) OF TWIN-AXIAL CABLE

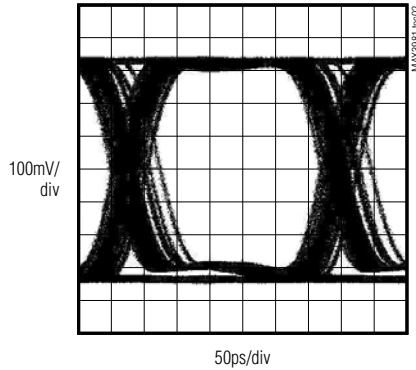

EQUALIZER OPERATING CURRENT vs. TEMPERATURE

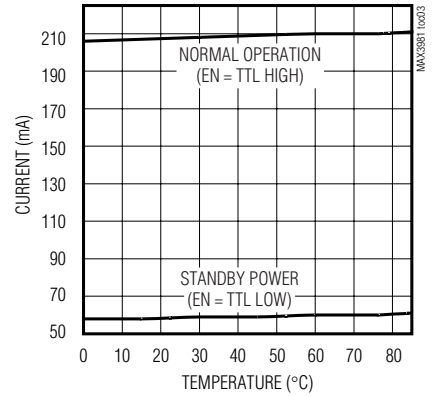

EQUALIZER INPUT EYE DIAGRAM AFTER 5m (16ft) OF SHIELDED TWISTED PAIR

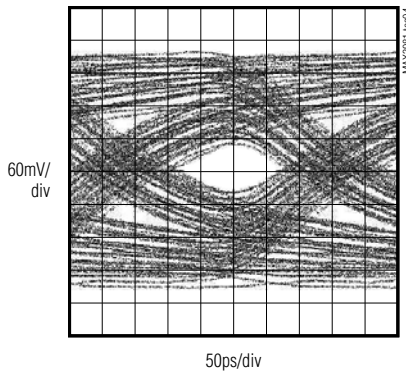

EQUALIZER OUTPUT EYE DIAGRAM AFTER 5m (16ft) OF SHIELDED TWISTED PAIR

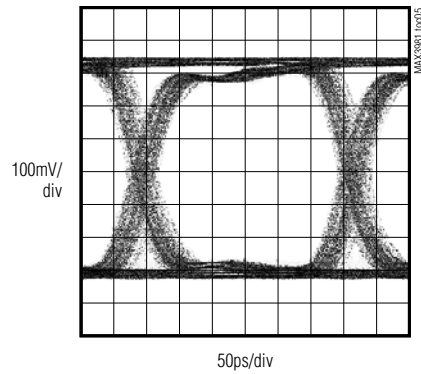

INPUT RETURN GAIN (S11, DIFFERENTIAL, INPUT SIGNAL = -60dBm, DEVICE POWERED OFF)

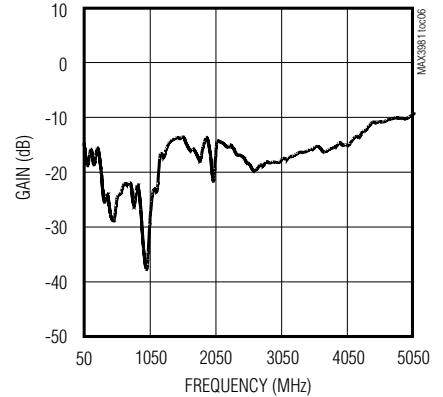

EQUALIZER DETERMINISTIC JITTER vs. CABLE LENGTH (K28.5 PATTERN, 3.125Gbps)

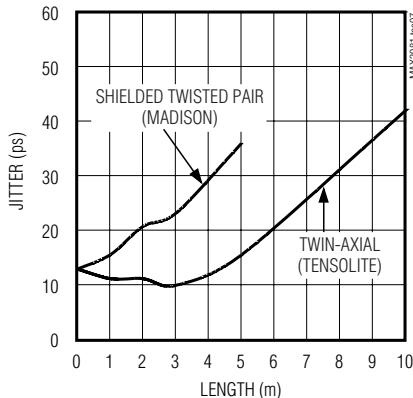

EQUALIZER DETERMINISTIC JITTER vs. CABLE LENGTH (K28.5 PATTERN, 2.5Gbps)

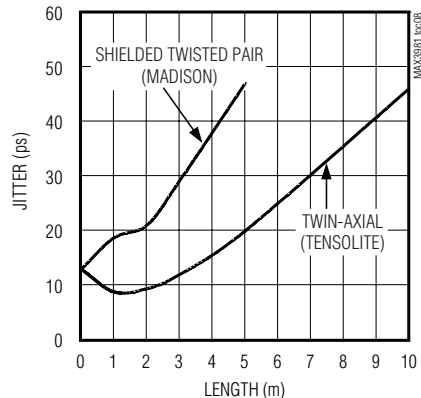

EQUALIZER LATENCY vs. TEMPERATURE

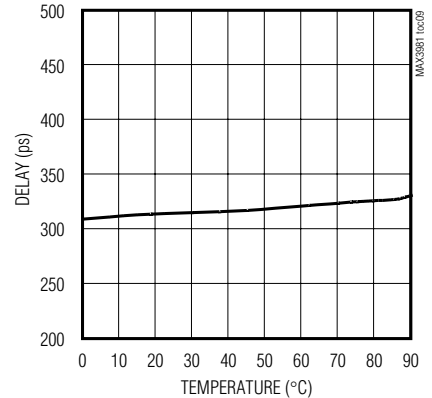

3.125Gbps XAUI Quad Cable Equalizer

Pin Description

MAX3981

PIN	NAME	FUNCTION
1, 5, 9, 13, 23, 27, 31, 35	VCC	+3.3V Supply Voltage
4, 8, 12, 16, 26, 30, 34, 38	GND	Supply Ground
2	IN1+	Positive Equalizer Input Channel 1, CML
3	IN1-	Negative Equalizer Input Channel 1, CML
6	IN2+	Positive Equalizer Input Channel 2, CML
7	IN2-	Negative Equalizer Input Channel 2, CML
10	IN3+	Positive Equalizer Input Channel 3, CML
11	IN3-	Negative Equalizer Input Channel 3, CML
14	IN4+	Positive Equalizer Input Channel 4, CML
15	IN4-	Negative Equalizer Input Channel 4, CML
17–22, 39–42	N.C.	No Connection. Leave unconnected.
24	OUT4-	Negative Equalizer Output Channel 4, CML
25	OUT4+	Positive Equalizer Output Channel 4, CML
28	OUT3-	Negative Equalizer Output Channel 3, CML
29	OUT3+	Positive Equalizer Output Channel 3, CML
32	OUT2-	Negative Equalizer Output Channel 2, CML
33	OUT2+	Positive Equalizer Output Channel 2, CML
36	OUT1-	Negative Equalizer Output Channel 1, CML
37	OUT1+	Positive Equalizer Output Channel 1, CML
43	EN	Enable Equalizer Input. A TTL high selects normal operation. A TTL low selects low-power standby mode.
44	SDET	Signal Detect Output for Channel 1. Produces a TTL high output when a signal is detected.
EP	Exposed Pad	Ground. The exposed pad must be soldered to the circuit board ground plane for proper thermal and electrical performance.

3.125Gbps XAUI Quad Cable Equalizer

Detailed Description

Receiver and Transmitter

The adaptive equalizer accepts four lanes of 3.125Gbps CML digital data signals and compensates each received signal for dielectric and skin losses. A limiting amp shapes the output of the equalizer and the output driver transmits the regenerated XAUI lanes as CML signals. The source impedance and termination impedance are 100Ω differential.

General Theory of Operation

Internally, the MAX3981 is comprised of signal-detect circuitry, four matched equalizers, and one equalizer control loop. The four equalizers are made up of a master equalizer and three slave equalizers. The adaptive control is generated from only channel 1. It is assumed that all channels have the same characterization in frequency content, coding, and transmission length.

The master equalizer consists of the following functions: signal detect, adaptive equalizer, equalizer control, limiting and output drivers. The signal detect indicates input signal power. When the input signal level is sufficiently high, the SDET output is asserted. This does not directly control the operation of the part.

The equalizer core reduces intersymbol interference (ISI), compensating for frequency-dependent, media-induced loss. The equalization control detects the spectral contents of the input signal and provides a control voltage to the equalizer core, adapting it to dif-

ferent media. The equalizer operation is optimized for short-run DC-balanced transmission codes such as 8b/10b codes.

CML Input and Output Buffers

The input and output buffers are implemented using current-mode logic (CML). Equivalent circuits are shown in Figures 2 and 3. For details on interfacing with CML, see Maxim application note HFAN-1.0, *Interfacing Between CML, PECL, and LVDS*. The common-mode voltages of the input and output are above 2.5V. AC-coupling capacitors are required when interfacing this part. Values of 0.10μF or greater are recommended.

Media Equalization

Equalization at the input port compensates for the high-frequency loss encountered with twin-axial cable or shielded twisted pair. This part is optimized for 10ft (3m) and 3.125Gbps; however, the part will reduce ISI for signals spanning longer distances and functions for data rates from 2Gbps to 4Gbps providing that short-length balanced codes, such as 8b/10b, are used.

Applications Information

Standby Mode

The standby state allows reduced-power operation. The TTL input, EN, must be set to TTL high for normal operation. A TTL low at EN forces the equalizer into the standby state. The signal EN does not affect the opera-

Functional Diagram

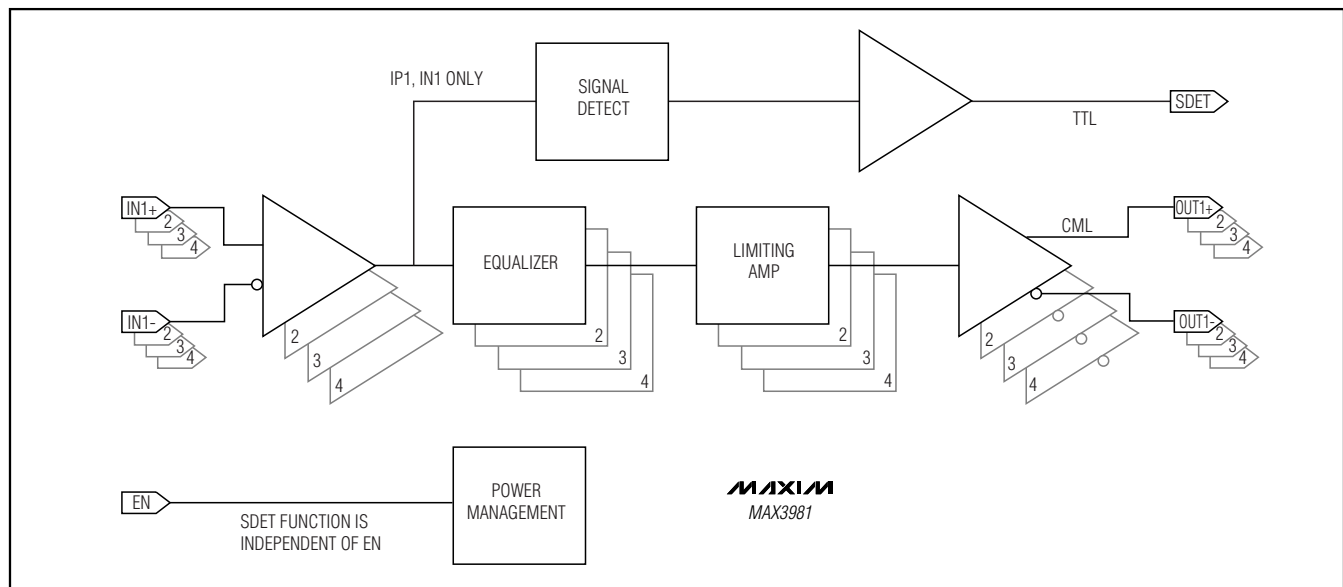

3.125Gbps XAUI Quad Cable Equalizer

MAX3981

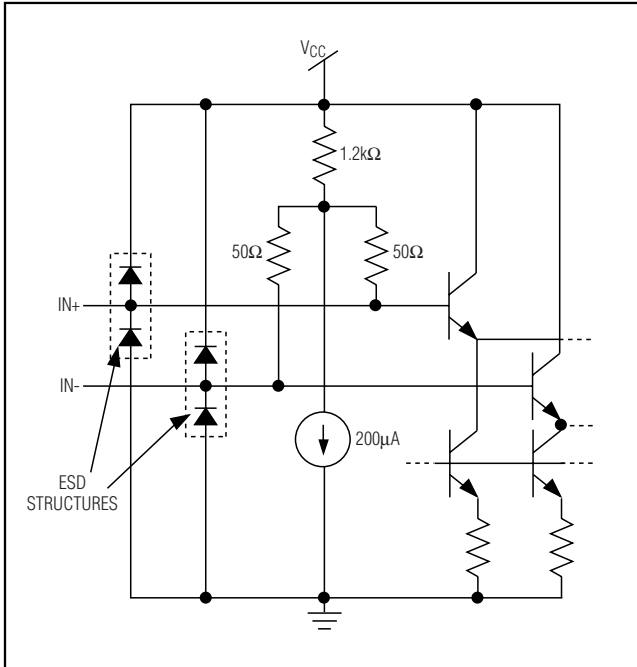

Figure 2. CML Input Buffer

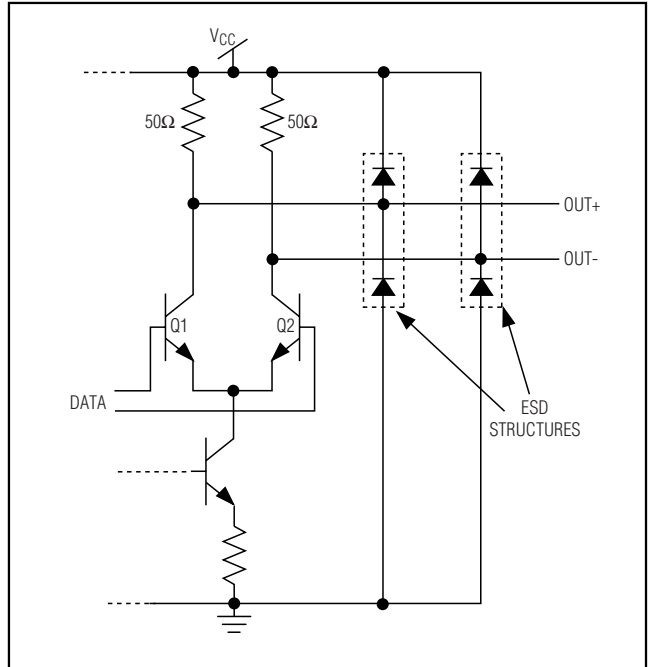

Figure 3. CML Output Buffer

tion of the signal detect (SDET) function. For constant operation, connect the EN signal directly to VCC.

Signal Detect with Standby Mode

Signal activity is detected on channel 1 only (IN1±). When the peak-to-peak differential voltage at IN1± is less than 30mVp-p, the TTL output SDET goes low. When the peak-to-peak differential voltage becomes greater than 100mVp-p, SDET is asserted high. SDET can be used to automatically force the equalizer into standby mode by connecting SDET directly to the EN input. When not used, SDET should not be connected.

The signal-detect function continues to operate while the part is in standby mode. While connected to the EN pin, the signal detect can “wake up” the part and resume normal operation.

Layout Considerations

Circuit board layout and design can significantly affect the MAX3981 performance. Use good high-frequency design techniques, including minimizing ground inductances and vias and using controlled-impedance transmission lines for the high-frequency data signals. Signals should be routed differentially to reduce EMI susceptibility and crosstalk. Power-supply decoupling capacitors should be placed as close as possible to the VCC pins.

Pin Configuration

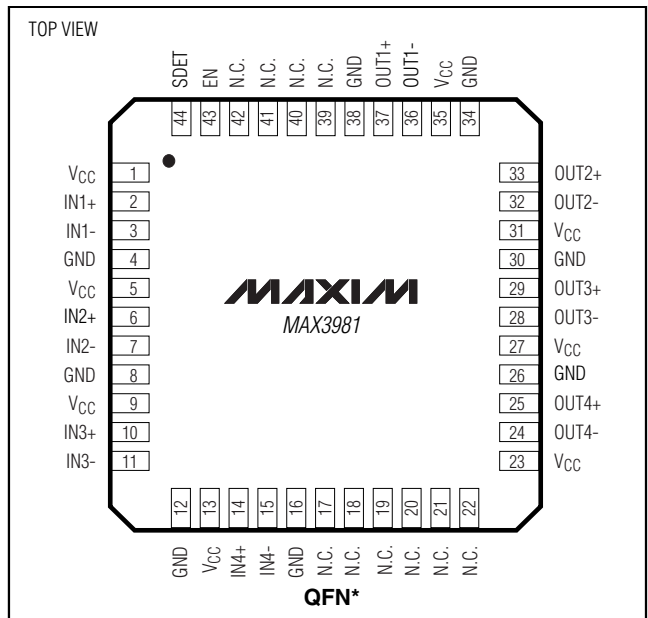

*Note: Exposed pad must be soldered to supply ground.

3.125Gbps XAUI Quad Cable Equalizer

Package Information

(The package drawing(s) in this data sheet may not reflect the most current specifications. For the latest package outline information go to www.maxim-ic.com/packages.)

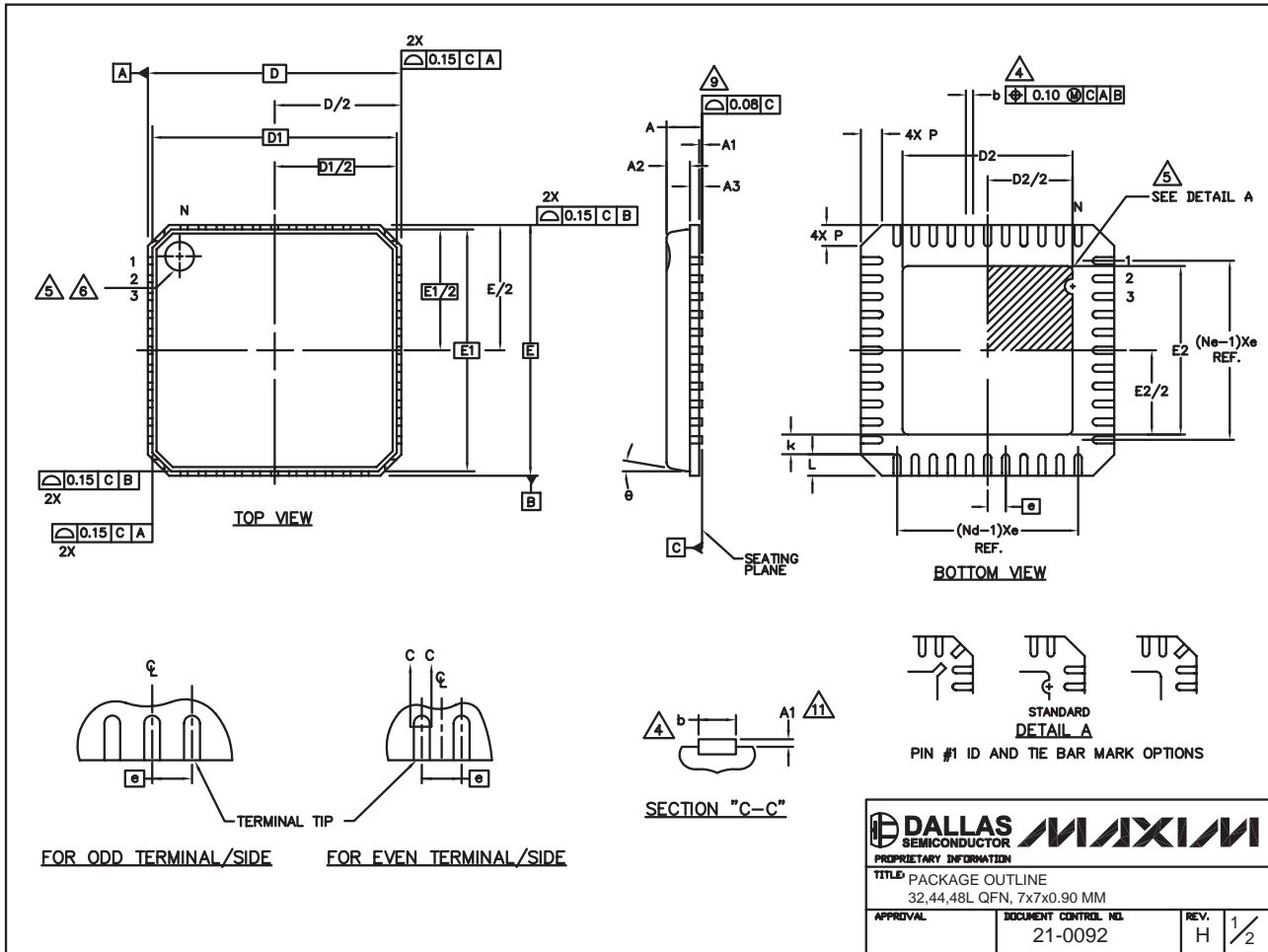

3.125Gbps XAUI Quad Cable Equalizer

MAX3981





Package Information (continued)

(The package drawing(s) in this data sheet may not reflect the most current specifications. For the latest package outline information go to www.maxim-ic.com/packages.)

COMMON DIMENSIONS									
PKG	32L 7x7			44L 7x7			48L 7x7		
SYMBOL	MIN.	NDM.	MAX.	MIN.	NDM.	MAX.	MIN.	NDM.	MAX.
A	0.80	0.90	1.00	0.80	0.90	1.00	0.80	0.90	1.00
A1	0.00	0.01	0.05	0.00	0.01	0.05	0.00	0.01	0.05
A2	0.00	0.65	1.00	0.00	0.65	1.00	0.00	0.65	1.00
A3	0.20 REF			0.20 REF			0.20 REF		
b	0.23	0.28	0.35	0.18	0.23	0.30	0.18	0.23	0.30
D	6.90	7.00	7.10	6.90	7.00	7.10	6.90	7.00	7.10
D1	6.75 BSC			6.75 BSC			6.75 BSC		
E	6.90	7.00	7.10	6.90	7.00	7.10	6.90	7.00	7.10
E1	6.75 BSC			6.75 BSC			6.75 BSC		
e	0.65 BSC			0.50 BSC			0.50 BSC		
k	0.25	-	-	0.25	-	-	0.25	-	-
L	0.35	0.55	0.75	0.35	0.55	0.75	0.30	0.40	0.50
N	32			44			48		
Nd	8			11			12		
Ne	8			11			12		
P	0.00	0.42	0.60	0.00	0.42	0.60	0.00	0.42	0.60
U	0°		12°	0°		12°	0°		12°

EXPOSED PAD VARIATIONS						
PKG. CODES	D2			E2		
	MIN.	NDM.	MAX.	MIN.	NDM.	MAX.
G3277-2	4.55	4.70	4.85	4.55	4.70	4.85
G4477-1	3.65	3.80	3.95	3.65	3.80	3.95
G4477-2	4.55	4.70	4.85	4.55	4.70	4.85
G4477-3	3.15	3.30	3.45	3.15	3.30	3.45
G4877-1	4.95	5.10	5.25	4.95	5.10	5.25
G4877-2	5.45	5.60	5.75	5.45	5.60	5.75

NOTES:

- DIE THICKNESS ALLOWABLE IS 0.305mm MAXIMUM (.012 INCHES MAXIMUM).
- DIMENSIONING & TOLERANCES CONFORM TO ASME Y14.5M. - 1994.
- N IS THE NUMBER OF TERMINALS.
Nd IS THE NUMBER OF TERMINALS IN X-DIRECTION & Ne IS THE NUMBER OF TERMINALS IN Y-DIRECTION.
-  DIMENSION b APPLIES TO PLATED TERMINAL AND IS MEASURED BETWEEN 0.20 AND 0.25mm FROM TERMINAL TIP.
-  THE PIN #1 IDENTIFIER MUST EXIST ON THE TOP SURFACE OF THE PACKAGE BY USING INDENTATION MARK OR INK/LASER MARKED. DETAILS OF PIN #1 IDENTIFIER IS OPTIONAL, BUT MUST BE LOCATED WITHIN ZONE INDICATED.
-  EXACT SHAPE AND SIZE OF THIS FEATURE IS OPTIONAL.
- ALL DIMENSIONS ARE IN MILLIMETERS.
- PACKAGE WARPAGE MAX 0.08mm.
-  APPLIED FOR EXPOSED PAD AND TERMINALS.
EXCLUDE EMBEDDED PART OF EXPOSED PAD FROM MEASURING.
- MEETS JEDEC MO220 EXCEPT DIMENSION "b" MINIMUM.
-  APPLY ONLY FOR TERMINAL.
- THIS PACKAGE OUTLINE APPLIES TO ANVIL SINGULATION(STEPED SIDES).

	
PROPRIETARY INFORMATION TITLE: PACKAGE OUTLINE, 32,44,48L QFN, 7x7x0.90 MM	
APPROVAL	DOCUMENT CONTROL NO. 21-0092
REV.	H 2/2

Maxim cannot assume responsibility for use of any circuitry other than circuitry entirely embodied in a Maxim product. No circuit patent licenses are implied. Maxim reserves the right to change the circuitry and specifications without notice at any time.

Maxim Integrated Products, 120 San Gabriel Drive, Sunnyvale, CA 94086 408-737-7600 9