

150Mbps Automotive Fiber Optic Receivers

General Description

The MAX3901/MAX3902 are optimized for low-cost polymer-clad silica (PCS) and plastic optical fiber (POF) automotive receivers. These parts operate over an extended -40°C to $+140^{\circ}\text{C}$ (junction) temperature range.

The MAX3901 features a $1.2\mu\text{A}$ to 1mA input range, a $+3.3\text{V}$ or $+5.0\text{V}$ supply voltage, operation from 8Mbps to 50Mbps , and a TTL output compatible with common automotive optical network interfaces.

The MAX3902 features a $1.2\mu\text{A}$ to 1mA input range, $+3.3\text{V}$ supply voltage, operation from 40Mbps to 150Mbps , and a differential output compatible with LVDS, PECL, and IEEE 1394b (S100 β).

Both circuits provide an input power detect and low-power standby mode with status output. No filter capacitors are required in the optical subassembly, thus enabling a low-cost receiver design. The circuits are available in die and wafer form.

Applications

Automotive Fiber Optic Receivers
IEEE 1394b (S100 β)

Features

- ◆ -40°C to $+140^{\circ}\text{C}$ Operating Junction Temperature
- ◆ Operation Up to 50Mbps (MAX3901)
- ◆ Operation Up to 150Mbps (MAX3902)
- ◆ $+3.3\text{V}$ or $+5.0\text{V}$ Power Supply (MAX3901)
- ◆ $1.2\mu\text{A}$ -p Input Sensitivity
- ◆ 1mA -p Input Overload
- ◆ Input Power Detect with Power-Reducing Standby Mode
- ◆ Active Output Pulldown During Standby Mode (MAX3901)
- ◆ Differential LVDS- or PECL-Compatible Output (MAX3902)
- ◆ TTL-Compatible Output (MAX3901)
- ◆ No Filter Capacitors Required in the Optical Subassembly

Ordering Information

PART	TEMP RANGE	PIN-PACKAGE
MAX3901E/D	-40°C to $+140^{\circ}\text{C}$	Dice*
MAX3902E/D	-40°C to $+140^{\circ}\text{C}$	Dice*

*Dice are designed to operate over a -40°C to $+140^{\circ}\text{C}$ junction temperature (T_j) range, but are tested and guaranteed at $T_A = +75^{\circ}\text{C}$.

Typical Operating Circuits

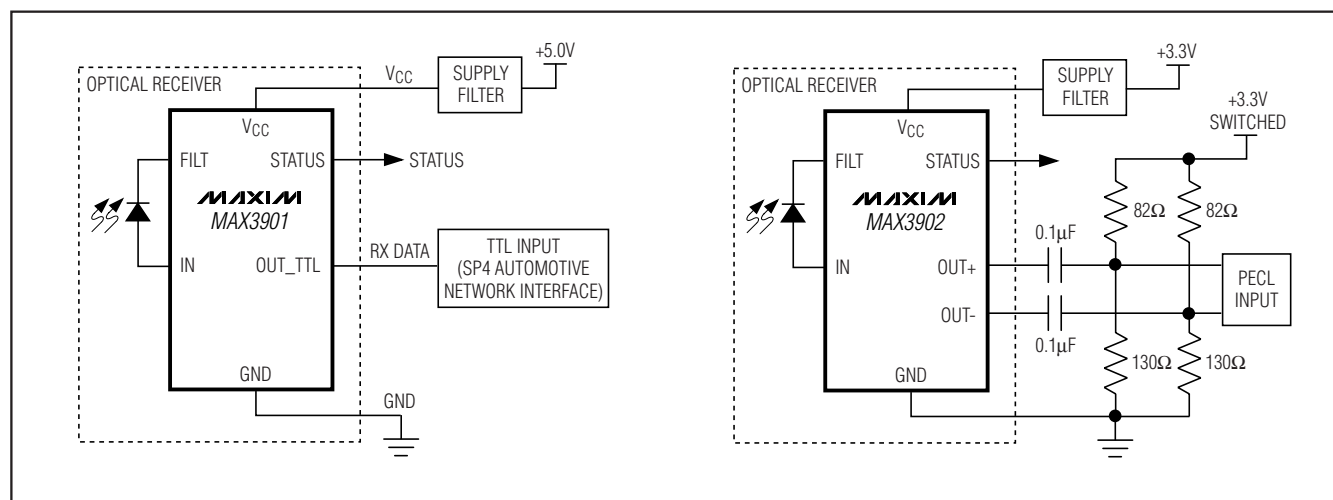

Typical Operating Circuits continued at end of data sheet.

150Mbps Automotive Fiber Optic Receiver

ABSOLUTE MAXIMUM RATINGS

Supply Voltage (V_{CC})-0.5V to +6V
 Current into IN±3mA
 Voltage at OUT+, OUT- (MAX3902)0V to +6V
 Current into OUT_TTL (MAX3901).....±10mA
 Current into FILT-3mA

Voltage at STATUS-0.5V to ($V_{CC} + 0.5$)
 Operating Junction Temperature-55°C to +150°C
 Storage Temperature Range-65°C to +175°C
 Die Attach Temperature.....+400°C

Stresses beyond those listed under "Absolute Maximum Ratings" may cause permanent damage to the device. These are stress ratings only, and functional operation of the device at these or any other conditions beyond those indicated in the operational sections of the specifications is not implied. Exposure to absolute maximum rating conditions for extended periods may affect device reliability.

ELECTRICAL CHARACTERISTICS—MAX3901

($V_{CC} = +3.135V$ to $+5.25V$, $C_{PD} = 2pF$; $T_J = -40°C$ to $+140°C$. Typical values are at $V_{CC} = +5.0V$ and $T_A = +25°C$, unless otherwise noted.)

PARAMETER	SYMBOL	CONDITION	MIN	TYP	MAX	UNIT
POWER SUPPLY						
Operating Power-Supply Current	I_{CC}	$T_J < +100°C$		14	22	mA
		$T_J < +140°C$			28	
Standby Current	I_{STBY}	$T_J < +85°C$		10	20	μA
		$T_J < +125°C$			80	
Power-Up Time	t_{PU}	From valid V_{CC} to STATUS low		0.06	1	ms
INPUT PARAMETERS						
Data Rate		Maximum 3 CIDs	8		50	Mbps
Input Extinction Ratio	E_r	$10\log(P_1 / P_0)$	3			dB
Input Sensitivity		(Notes 1, 2)		0.4	1.2	μA_{P-P}
Input Overload		$I_{IN} \leq 600\mu A$	1.0			$m A_{P-P}$
Input Bias Voltage	V_{IN}			0.8	1.0	V
FILT PIN						
Voltage at FILT	V_{FILT}	$I_{FILT} = -600\mu A$, referenced to V_{CC}		-0.35	-0.45	V
Filter Resistor	R_{FILT}			100		$k\Omega$
DATA OUTPUT (OUT_TTL) $R_{LOAD} = 50k\Omega$ to GND, $C_{OUT} = 15pF$						
Output High	V_{OH}		2.5	2.7		V
Output Low	V_{OL}			0.3	0.4	V
Output Voltage During Standby		STATUS = high, $I_{OUT} = 30\mu A$		0.06	0.4	V
Output Switching Time	t_r, t_f	10% to 90%, data rate $\leq 45Mbps$		5	8.5	ns
Pulse-Width Variation	PWV	45Mbps (Notes 1, 3), $1.2\mu A_{P-P} \leq I_{IN} \leq 1mA_{P-P}$	0.86		1.14	UI
Average Pulse-Width Distortion	PWD	45Mbps (Notes 1, 3)	-0.07		+0.07	UI
Data-Dependent Jitter	DDJ	(Notes 1, 4)		0.035	0.082	UI
Uncorrelated Jitter (Random Jitter)	RJ	$I_{IN} \geq 1.2\mu A_{P-P}$ (Note 1)		0.007	0.015	UI _{RMS}
POWER DETECT (STATUS)						
Input for STATUS High	I_{STH}	Standby mode	50	160		nA
Input for STATUS Low	I_{STL}	Operating mode		210	630	nA
STATUS Low Voltage	$V_{STATUS-L}$	$I_{STATUS} < 1mA$			0.4	V
STATUS High Voltage	$V_{STATUS-H}$	$I_{STATUS} > -25\mu A$	2.4			V
		$I_{STATUS} > -20\mu A, V_{CC} \geq 4.75V$	4			

150Mbps Automotive Fiber Optic Receiver

MAX3901/MAX3902

ELECTRICAL CHARACTERISTICS—MAX3901 (continued)

($V_{CC} = +3.135V$ to $+5.25V$, $C_{PD} = 2pF$; $T_j = -40^{\circ}C$ to $+140^{\circ}C$. Typical values are at $V_{CC} = +5.0V$ and $T_A = +25^{\circ}C$, unless otherwise noted.)

PARAMETER	SYMBOL	CONDITION	MIN	TYP	MAX	UNIT
STATUS Resistance	R _{STATUS}		10	16	24	k Ω
Power-Detect Time	t _{OP}	Transition to operating mode (Note 5)		0.2	0.5	ms
	t _{STBY}	Transition to standby mode (Note 6)		16	100	μ s

Note 1: Guaranteed by design and characterization.

Note 2: BER = 1E-9, biphas-coded data containing three consecutive, identical digits. Waveform shaped by 39MHz four-pole filter.

Note 3: See Figure 1. V_{TH} is 1.5V for the MAX3901, 0V for (AC-coupled) differential output from the MAX3902. Data is biphas-coded with three consecutive, identical digits added. Data input to the MAX3901 is shaped by a 39MHz four-pole filter. Data input to the MAX3902 is shaped by a 117MHz four-pole filter.

Maximum PWV = MAX [t_{1max}, t_{2max} - 1UI, t_{3max} - 2UI].

Minimum PWV = MIN [t_{1min}, t_{2min} - 1UI, t_{3min} - 2UI].

Minimum PWD = MIN [(t_{n-max} + t_{n-min} - 2 x n x UI)/2], where n = 1, 2, 3.

Maximum PWD = MAX [(t_{n-max} + t_{n-min} - 2 x n x UI)/2], where n = 1, 2, 3.

Note 4: Data-dependent jitter is measured as shown in *MOST Specification of Physical Layer*, Version 1.1, data rate = 45Mbps.

Note 5: Time from I_{IN} > I_{STL} to STATUS = low, C_{STATUS} < 10pF.

Note 6: Time from I_{IN} < I_{STH} to STATUS = high, C_{STATUS} < 10pF.

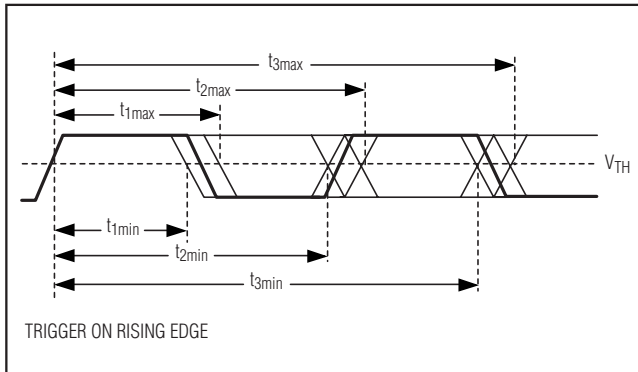

Figure 1. PWV and PWD Timing Diagrams

150Mbps Automotive Fiber Optic Receiver

ELECTRICAL CHARACTERISTICS—MAX3902

($V_{CC} = +3.0V$ to $+3.6V$, $C_{PD} = 2pF$; $T_j = -40^{\circ}C$ to $+140^{\circ}C$. Typical values are at $V_{CC} = +3.3V$ and $T_A = +25^{\circ}C$, unless otherwise noted.)

PARAMETER	SYMBOL	CONDITION	MIN	TYP	MAX	UNIT
POWER SUPPLY						
Operating Power-Supply Current	I_{CC}			26	35	mA
Standby Current	I_{STBY}	$T_J < +85^{\circ}C$		9	18	μA
		$T_J < +125^{\circ}C$			80	
Power-Up Time	t_{PU}	From valid V_{CC} to STATUS low		0.06	1	ms
INPUT PARAMETERS						
Data Rate		Maximum 5 CIDs	40		150	Mbps
Input Extinction Ratio	E_r	$10\log(P_1 / P_0)$	3			dB
Input Sensitivity		(Notes 1, 7)			1.2	μA_{P-P}
Input Overload		$I_{IN} \leq 600\mu A$	1.0			$m A_{P-P}$
Input Bias Voltage	V_{IN}			0.75	1.0	V
FILT PIN PARAMETERS						
Voltage at FILT	V_{FILT}	$I_{FILT} = -600\mu A$, referenced to V_{CC}		-0.35	-0.45	V
Filter Resistor	R_{FILT}			100		$k\Omega$
DIFFERENTIAL OUTPUT						
Differential Signal Output	V_{OUT}	Total signal measured between the two outputs	600	800	1000	mV_{P-P}
Output Resistance	R_{OUT}	Single ended	85	100	115	Ω
Output Switching Time	t_r, t_f	10% to 90%, $i_{IN} \geq 2\mu A_{P-P}$		1.5	2.5	ns
Deterministic Jitter	DJ	(Notes 1, 8)		0.03	0.10	UI
Random Jitter	RJ	$i_{IN} = 2.0\mu A_{P-P}$, $E_r = 3dB$, input filter 117MHz (Note 1)		135	215	μs_{RMS}
		$i_{IN} = 2\mu A_{P-P}$, $E_r = 10dB$, input filter = 117MHz		122		
Pulse-Width Variation	PWV	(Notes 1, 3) $2\mu A_{P-P} \leq i_{IN} \leq 1mA_{P-P}$	0.88		1.12	UI
Average Pulse-Width Distortion	PWD	(Notes 1, 3)	-0.045		+0.042	UI
Data-Dependent Jitter	DDJ	(Notes 1, 4)		0.01	0.071	UI
POWER DETECT (STATUS)						
Input for STATUS High	I_{STH}	Standby mode	50	160		nA
Input for STATUS Low	I_{STL}	Operating mode		210	630	nA
STATUS Low Voltage	$V_{STATUS-L}$	$I_{STATUS} < 1mA$			0.4	V
STATUS High Voltage	$V_{STATUS-H}$	$I_{STATUS} > -25\mu A$	2.4			V
STATUS Resistance	R_{STATUS}		10	16	24	$k\Omega$
Power-Detect Time	t_{OP}	Transition to operating mode (Note 5)		0.2	0.5	ms
	t_{STBY}	Transition to standby mode (Note 6)		16	100	μs

Note 7: BER = $1E-9$, test pattern is K28.5 (00111110101100000101), waveform shaped by a 117MHz four-pole filter.

Note 8: Tested with K28.5 pattern at 45Mbps and 150Mbps, $2.0\mu A_{P-P} < i_{IN} < 1mA_{P-P}$, waveform shaped by 117MHz four-pole filter. Deterministic jitter (DJ) is the peak-to-peak deviation from ideal time crossings, measured at the zero-level crossings of the differential output.

150Mbps Automotive Fiber Optic Receiver

MAX3901 Typical Operating Characteristics

($V_{CC} = +5.0V$, $C_{PD} = 2pF$, test pattern is biphase-coded data with 3 CIDs at 50Mbps, $T_A = +25^\circ C$, unless otherwise noted.)

MAX3901/MAX3902

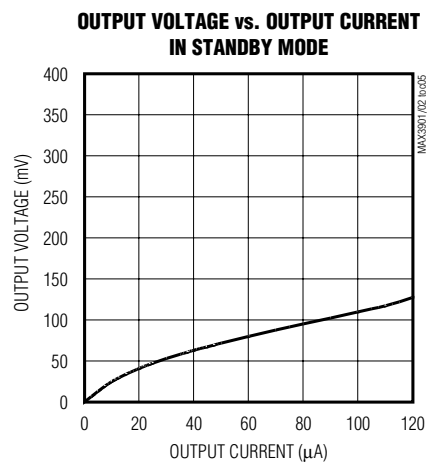
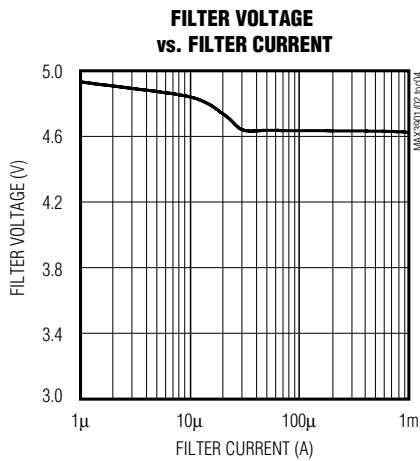
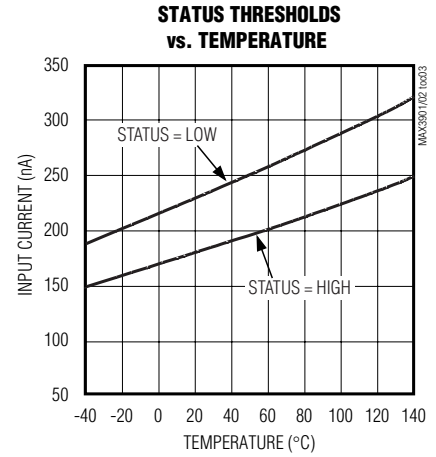
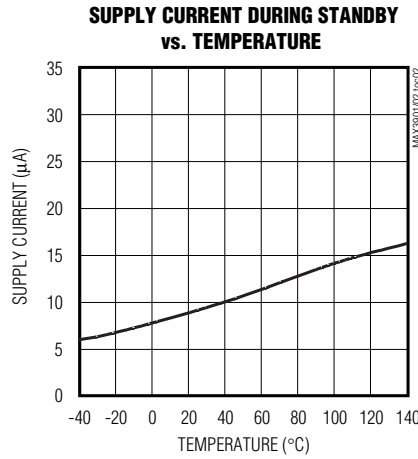
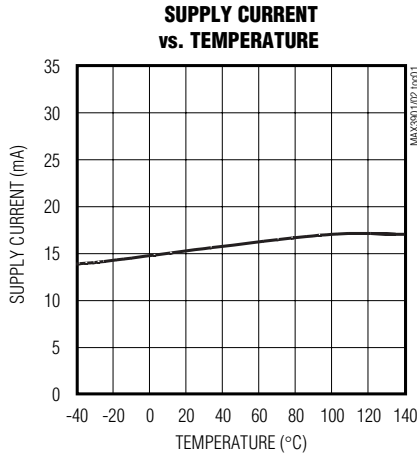

150Mbps Automotive Fiber Optic Receiver

MAX3901 Typical Operating Characteristics (continued)

(V_{CC} = +5.0V, C_{PD} = 2pF, test pattern is biphase-coded data with 3 CIDs at 50Mbps, T_A = +25°C, unless otherwise noted.)

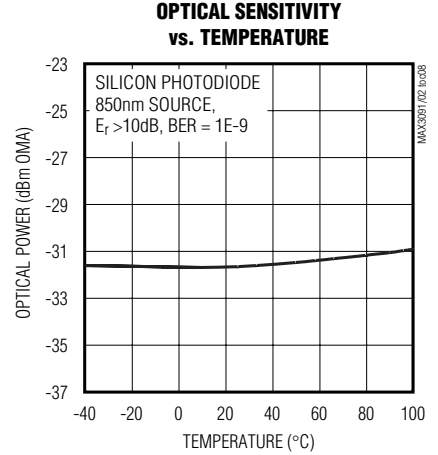
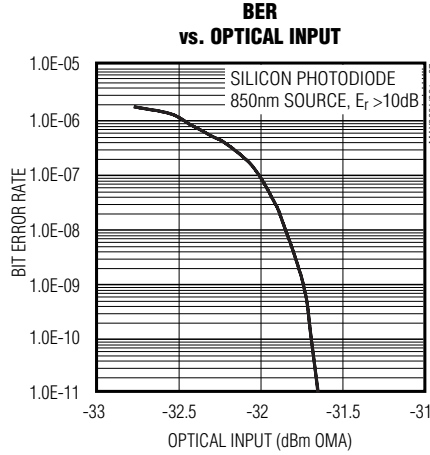
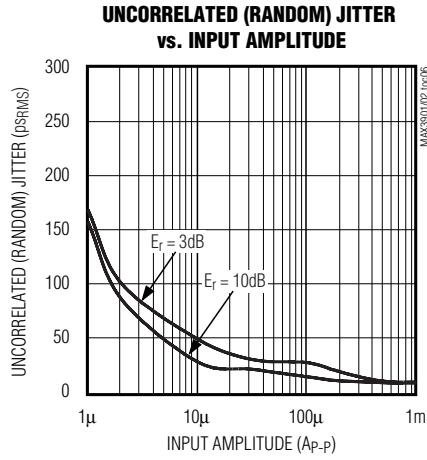

**OUTPUT EYE DIAGRAM
(+3dBm OMA OPTICAL INPUT AT +25°C
SILICON PHOTODIODE WITH 850nm SOURCE)**

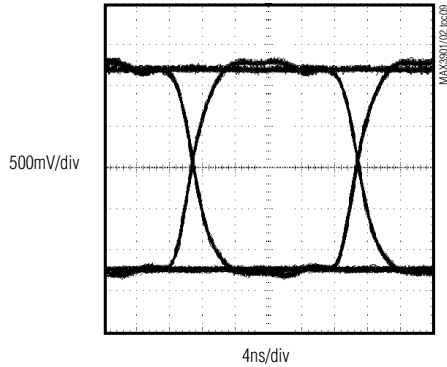

**OUTPUT EYE DIAGRAM
(-27dBm OMA OPTICAL INPUT AT +25°C
SILICON PHOTODIODE WITH 850nm SOURCE)**

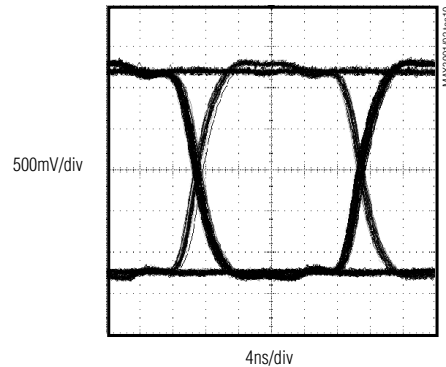

150Mbps Automotive Fiber Optic Receiver

MAX3902 Typical Operating Characteristics

($V_{CC} = +5.0V$, $C_{PD} = 2pF$, test pattern is K28.5 at 150Mbps, $T_A = +25^\circ C$, unless otherwise noted.)

MAX3901/MAX3902

SUPPLY CURRENT vs. TEMPERATURE

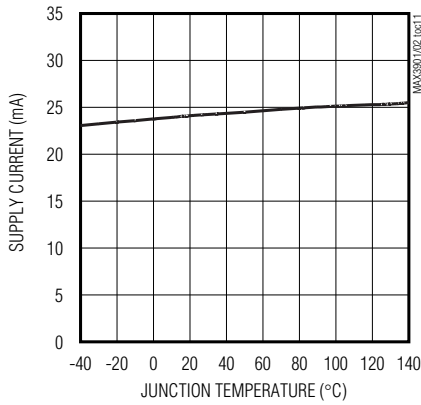

DETERMINISTIC JITTER vs. INPUT AMPLITUDE

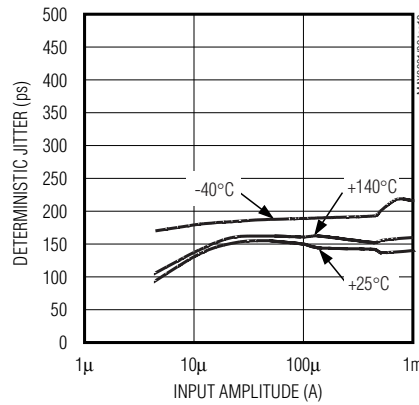

OPTICAL SENSITIVITY vs. TEMPERATURE

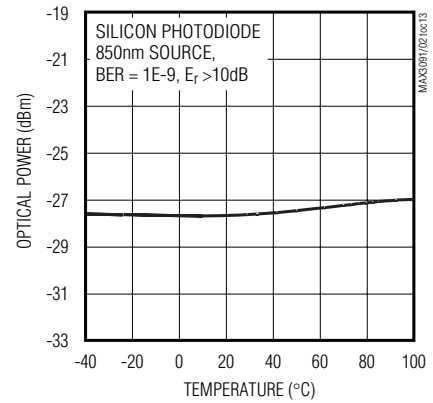

BER vs. OPTICAL INPUT

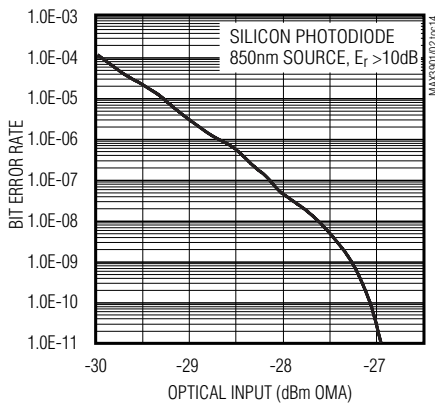

OUTPUT EYE DIAGRAM (2µAp-p ELECTRICAL INPUT AT $T_J = -40^\circ C$)

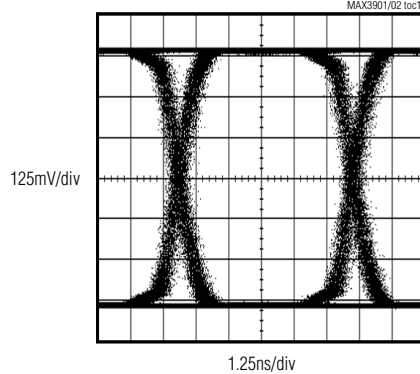

OUTPUT EYE DIAGRAM (2µAp-p ELECTRICAL INPUT AT $T_J = +140^\circ C$)

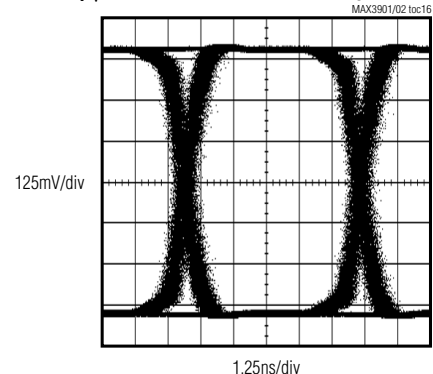

OUTPUT EYE DIAGRAM (1mAp-p ELECTRICAL INPUT AT $T_J = +25^\circ C$)

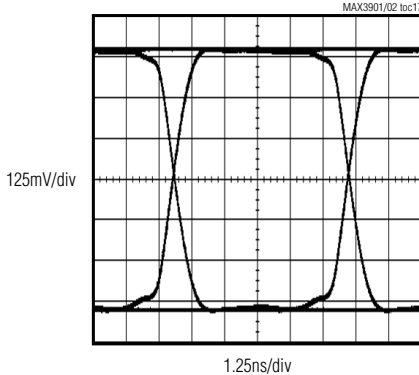

OUTPUT EYE DIAGRAM (-27.7dBm OMA OPTICAL INPUT AT $T_J = +25^\circ C$) SILICON PHOTODIODE WITH 850nm SOURCE

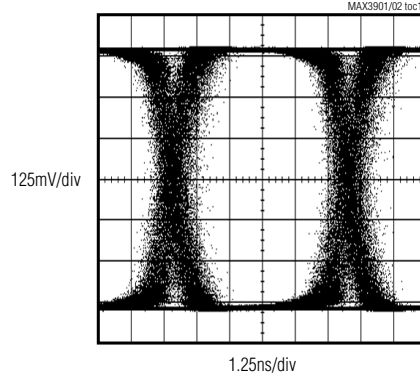

OUTPUT EYE DIAGRAM (+3dBm OMA OPTICAL INPUT AT $T_J = +25^\circ C$) SILICON PHOTODIODE WITH 850nm SOURCE

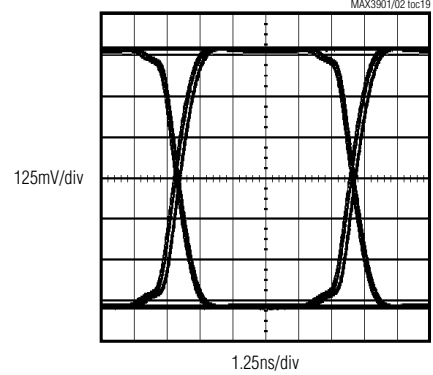

150Mbps Automotive Fiber Optic Receiver

Pad Description

BOND PAD	MAX3901 NAME	MAX3902 NAME	FUNCTION
1	FILT	FILT	Filter Pin. Must be connected to photodiode cathode for the IC to operate. This pin provides connection to an integrated photodiode filter.
2	IN	IN	Data Input. Connect photodiode anode to this pin.
3, 4, 13, 14, 15	N.C.	N.C.	No Connection
5, 6, 7	V _{CC}	V _{CC}	Supply Voltage
8, 16, 17	GND	GND	Circuit Ground
9	N.C.	OUT+	Noninverting Data Output. Current flowing into IN causes the voltage at OUT+ to increase.
10	N.C.	OUT-	Inverting Data Output. Current flowing into IN causes the voltage at OUT- to decrease.
11	STATUS	STATUS	Status Monitor. STATUS is TTL low when the receiver is in operating mode. STATUS is TTL high when the receiver is in standby mode.
12	OUT_TTL	N.C.	TTL Data Output. Current flowing into IN causes the voltage at OUT_TTL to increase.

Detailed Description

The MAX3901/MAX3902 receivers are optimized for automotive fiber optic applications. The MAX3901 is a single-ended TTL output receiver. The MAX3902 is a differential CML output receiver. The MAX3901/MAX3902 are both comprised of a transimpedance amplifier, a voltage-gain amplifier, an output buffer, a DC cancellation circuit, and a power detector with status monitor, as shown in Figure 2.

Signal Path

The signal path consists of a transimpedance amplifier, a voltage-gain amplifier, and a DC cancellation circuit. The transimpedance amplifier converts input current to voltage. The voltage-gain amplifier converts single-ended to differential voltage. The DC cancellation circuit uses low-frequency feedback to remove the DC component of the input signal. This feature centers the input signal within the transimpedance amplifier's linear range, thereby reducing pulse-width distortion. The highpass response of the DC cancellation circuit limits the number of consecutive identical digits that can be tolerated.

TTL Output Buffer

The output buffer for the MAX3901 is a single-ended TTL output designed to drive a high-impedance load. Output capacitance should be less than 15pF to ensure stable operation. The TTL output is not compatible with 50Ω test equipment. Use a high-impedance probe to monitor the output.

During standby mode, the TTL output is actively pulled to a low state.

CML Output Buffer

The output buffer for the MAX3902 is a differential CML output designed to drive a 100Ω differential load between OUT+ and OUT- (Figure 3). For optimum supply noise rejection, the MAX3902 should be terminated with a differential load. If a single-ended output is required, both the used and the unused outputs should be terminated in a similar manner.

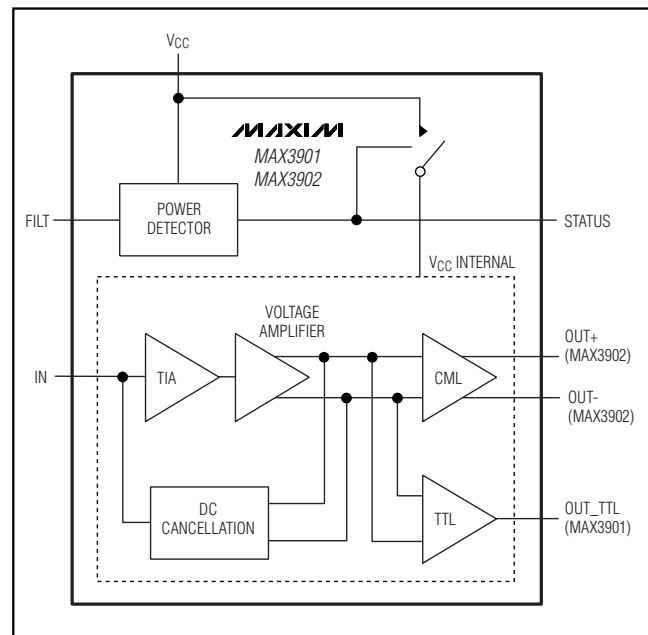

Figure 2. Functional Diagram

150Mbps Automotive Fiber Optic Receiver

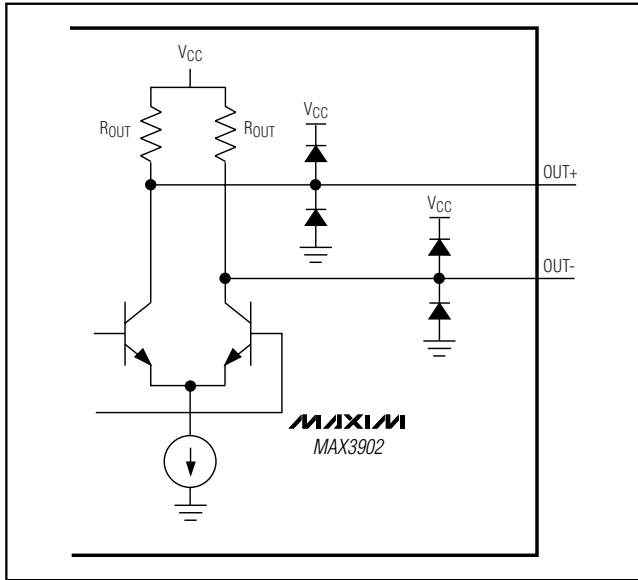

Figure 3. MAX3902 CML Output

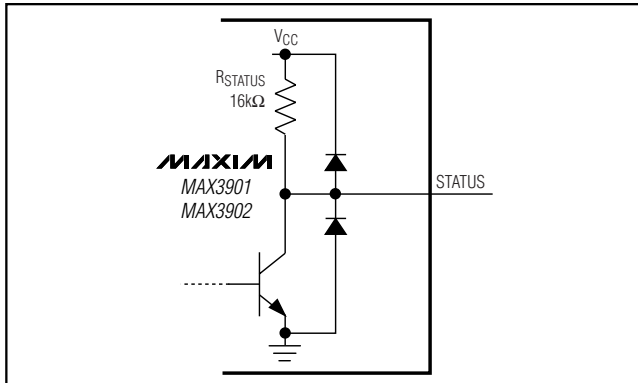

Figure 4. STATUS Monitor Output

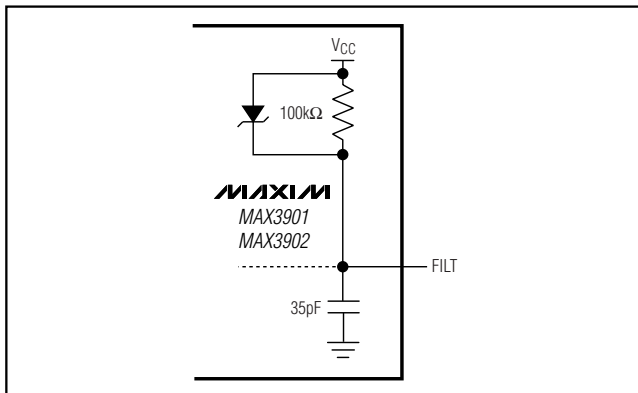

Figure 5. FILT pad

The coupling capacitor should be 0.1μF or larger. Refer to Application Note HFAN-1.1: *Choosing AC-Coupling Capacitors* for a more detailed discussion.

Status Monitor

The MAX3901/MAX3902 include a status monitor (Figure 4). The average current at the FILT (Figure 5) pad determines whether the MAX3901/MAX3902 are in operating or standby mode. STATUS is TTL low when the receiver is in operating mode. STATUS is TTL high when the receiver is in standby mode.

Applications Information

Optical Power Relations

Many of the MAX3901/MAX3902 specifications relate to the input signal amplitude. Figure 6 and Table 1 show relations that are helpful for converting optical power to input signal when designing with the MAX3901/MAX3902.

Wire Bonding

For high-current density and reliable operation, the MAX3901 and MAX3902 use gold metalization. For best results, use gold-wire ball-bonding techniques. Use caution if attempting wedge bonding. Bond-pad size is 94.4μm x 94.4μm, and bond-pad metal thickness is 1.2μm. Refer to Maxim Application Note, HFAN-08.0.1: *Understanding Bonding Coordinates and Physical Die Size* for additional information.

Table 1. Optical Power Relations*

PARAMETER	SYMBOL	RELATION
Average Power	P_{AVE}	$P_{AVE} = (P_0 + P_1) / 2$
Extinction Ratio	E_r	$E_r = P_1 / P_0$
		$\frac{2P_{AVE} + OMA}{2P_{AVE} - OMA}$
Optical Power of a "1"	P_1	$P_1 = 2P_{AVE} \frac{E_r}{E_r + 1}$
Optical Power of a "0"	P_0	$P_0 = 2P_{AVE} / E_r + 1$
Optical Modulation Amplitude	OMA	$OMA = P_1 - P_0 = 2P_{AVE} \frac{E_r - 1}{E_r + 1}$

* Assuming a 50% average mark density.

150Mbps Automotive Fiber Optic Receiver

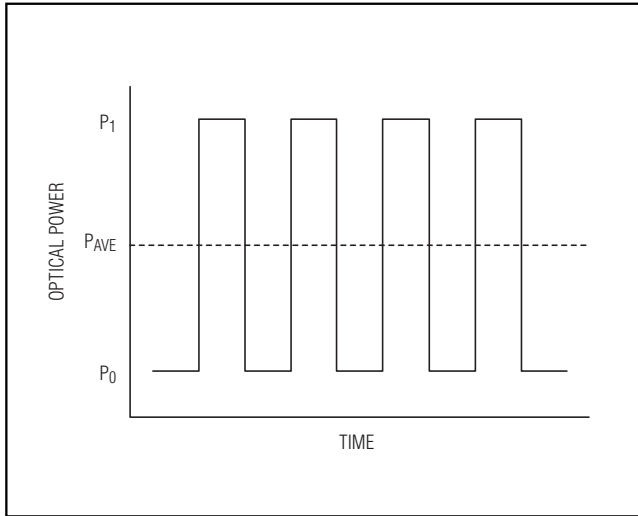

Figure 6. Optical Power Relations

Chip Information

TRANSISTOR COUNT: 1175

PROCESS: Silicon Bipolar, CB30HM

Die Thickness: 12 mils (300 μ m)

Table 2 gives center pad coordinates for the MAX3901 and MAX3902 bond pads.

Table 2. Bond-Pad Information

PAD	NAME		COORDINATES (μ m)	
	MAX3901	MAX3902	X	Y
BP1	FILT	FILT	51.0	1302.0
BP2	IN	IN	51.0	1128.0
BP3	N.C.	N.C.	51.0	825.0
BP4	N.C.	N.C.	51.0	399.0
BP5	VCC	VCC	51.0	225.0
BP6	VCC	VCC	51.0	51.0
BP7	VCC	VCC	291.0	-30.0
BP8	GND	GND	918.0	-30.0
BP9	N.C.	OUT+	1140.0	-30.0
BP10	N.C.	OUT-	1359.0	-30.0
BP11	STATUS	STATUS	1548.0	-30.0
BP12	OUT_TTL	N.C.	1581.0	279.0
BP13	N.C.	N.C.	936.0	1338.0
BP14	N.C.	N.C.	762.0	1338.0
BP15	N.C.	N.C.	585.0	1338.0
BP16	GND	GND	408.0	1338.0
BP17	GND	GND	231.0	1338.0

Coordinate 0,0 is the lower left corner of the passivation opening for pad 6.

Table 3. Typical Optical Receiver Performance

RECEIVER CONFIGURATION OPTICAL PARAMETER	PCS 850nm $\rho = 0.5A/W$ MAX3901 Receiver	POF 650nm $\rho = 0.3A/W$ MAX3901 Receiver	PCS 850nm $\rho = 0.5A/W$ MAX3902 Receiver
Worst-Case Sensitivity BER = $1E - 9$ and STATUS = Low	-26.2dBm OMA	-27dBm	-26.2dBm OMA
Expected Typical Sensitivity	-31.5dBm OMA	-29dBm	-30.5dBm OMA
Optical Overload	+3dBm OMA	+5dBm	+3dBm OMA
Typical Input for Standby Mode	-35dBm	-37dBm	-35dBm
Typical Input for Operating Mode	-32.5dBm	-34.5dBm	-32.5dBm

150Mbps Automotive Fiber Optic Receiver

Typical Operating Circuits (continued)

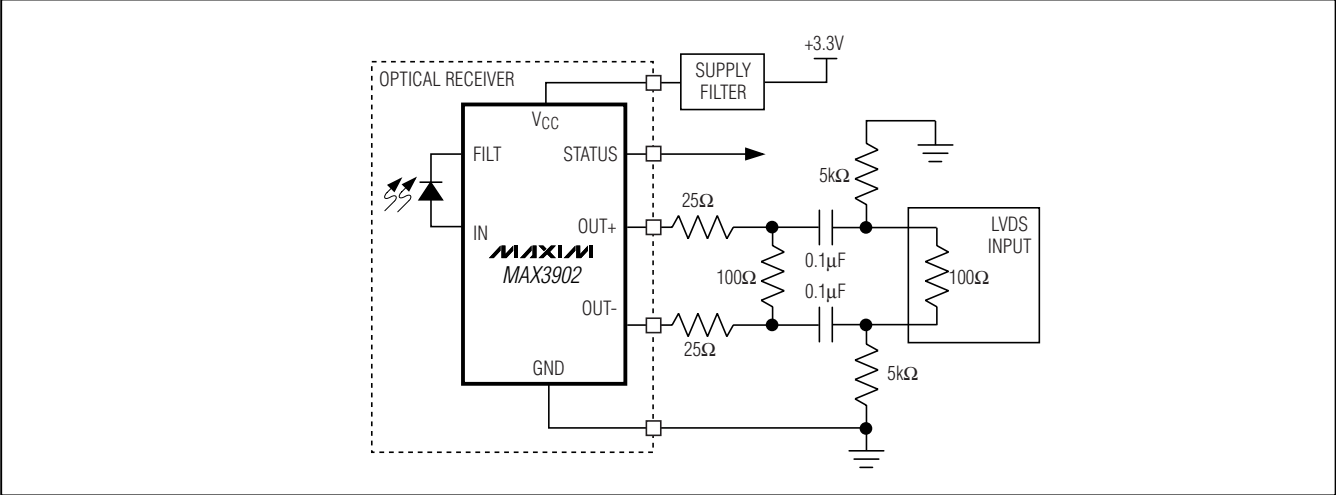

MAX3901/MAX3902

150Mbps Automotive Fiber Optic Receiver

MAX3901/MAX3902

MAX3901 Chip Topography

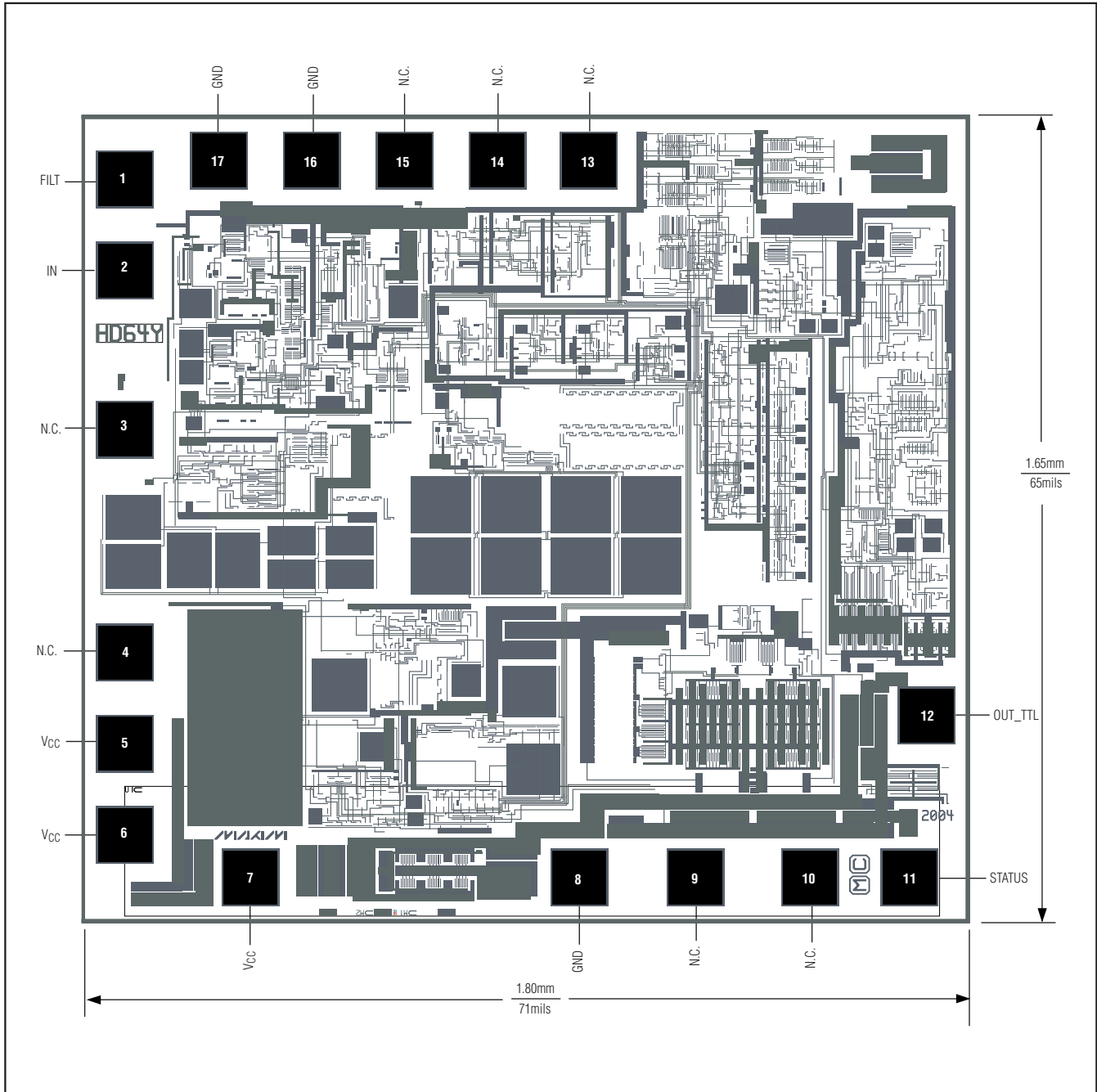

150Mbps Automotive Fiber Optic Receiver

MAX3902 Chip Topography

MAX3901/MAX3902

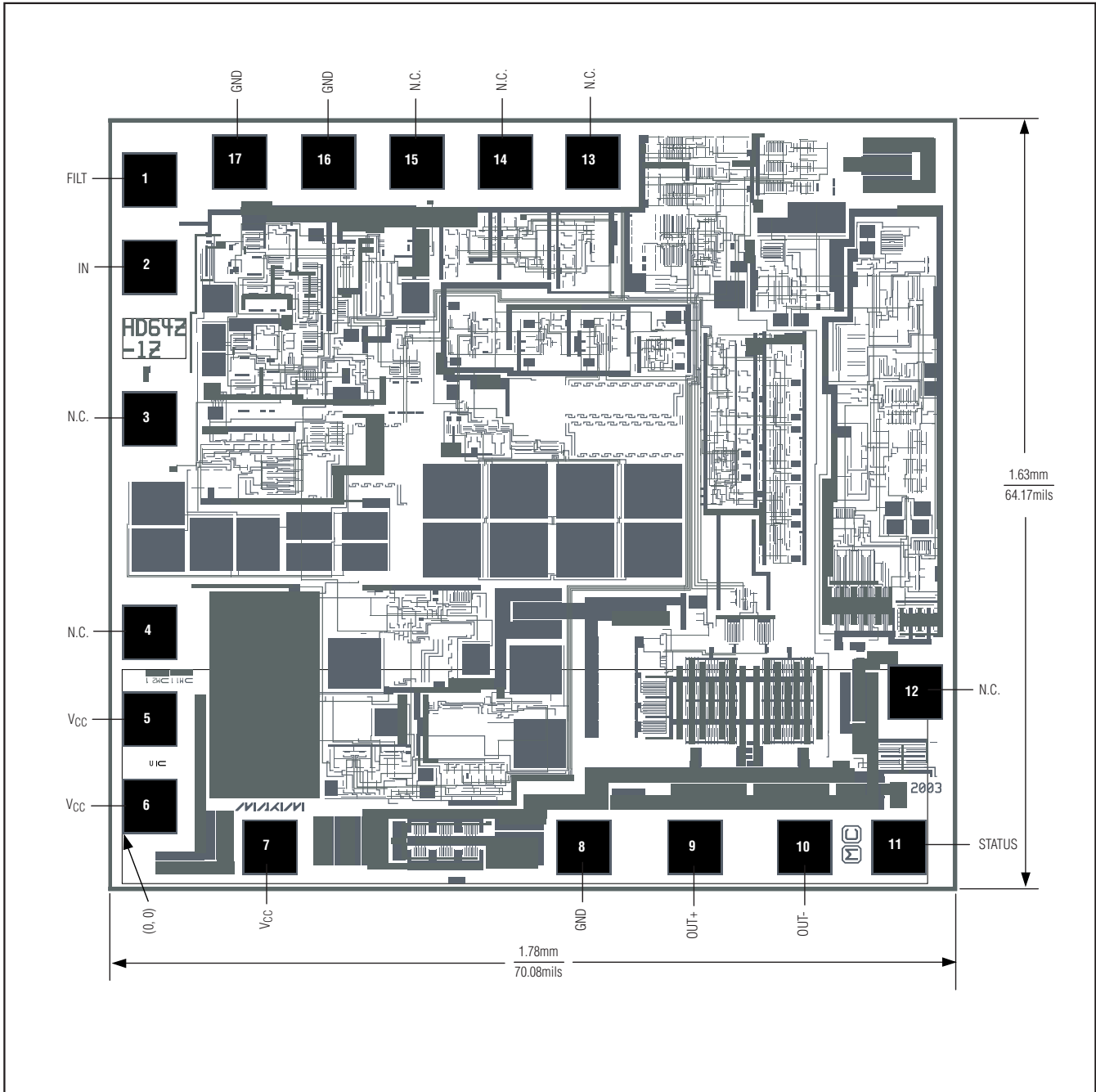

Maxim cannot assume responsibility for use of any circuitry other than circuitry entirely embodied in a Maxim product. No circuit patent licenses are implied. Maxim reserves the right to change the circuitry and specifications without notice at any time.

Maxim Integrated Products, 120 San Gabriel Drive, Sunnyvale, CA 94086 408-737-7600 _____ **13**