

# MAXIM

## Upstream CATV Amplifier with On-Chip Anti-Alias Filter

**MAX3507**

### General Description

The MAX3507 is a variable-gain power amplifier for use in CATV upstream transmitters. The variable-gain feature has 55dB of dynamic range and is controlled by a 3-wire SPI™ bus. The device is capable of generating +64dBmV output (16QAM/QPSK) when driven with a +34dBmV nominal input signal. The on-chip anti-alias lowpass filter with 75MHz cutoff frequency saves system design cost and space. The optional positive slope generator provides system design flexibility.

The device operates from a single +5V supply and draws 220mA nominal during transmit at max gain (100% duty cycle). For burst-type transmissions, the device is shut off between bursts to minimize noise and save power while still maintaining a match at the output. The device is optimized for high linearity with harmonic levels below -55dBc.

The MAX3507 is available in a 28-pin QFN package and operates over the extended industrial temperature range (-40°C to +85°C).

### Applications

- Cable Modem Upstream Transmitter
- Set-Top Box Upstream Transmitter
- Telephony Over Cable

### Features

- ◆ Built-In 5th-Order Elliptic Anti-Aliasing Filter
- ◆ 5MHz to 65MHz Operation
- ◆ 55dB Gain Control Range
- ◆ Optional Positive Slope Generator
- ◆ 55dB Spurious-Free Dynamic Range Over Transmit Band

### Ordering Information

PART	TEMP. RANGE	PIN-PACKAGE
MAX3507EGI	-40°C to +85°C	28 QFN

*Pin Configuration appears at end of data sheet.*

### Typical Operating Circuit

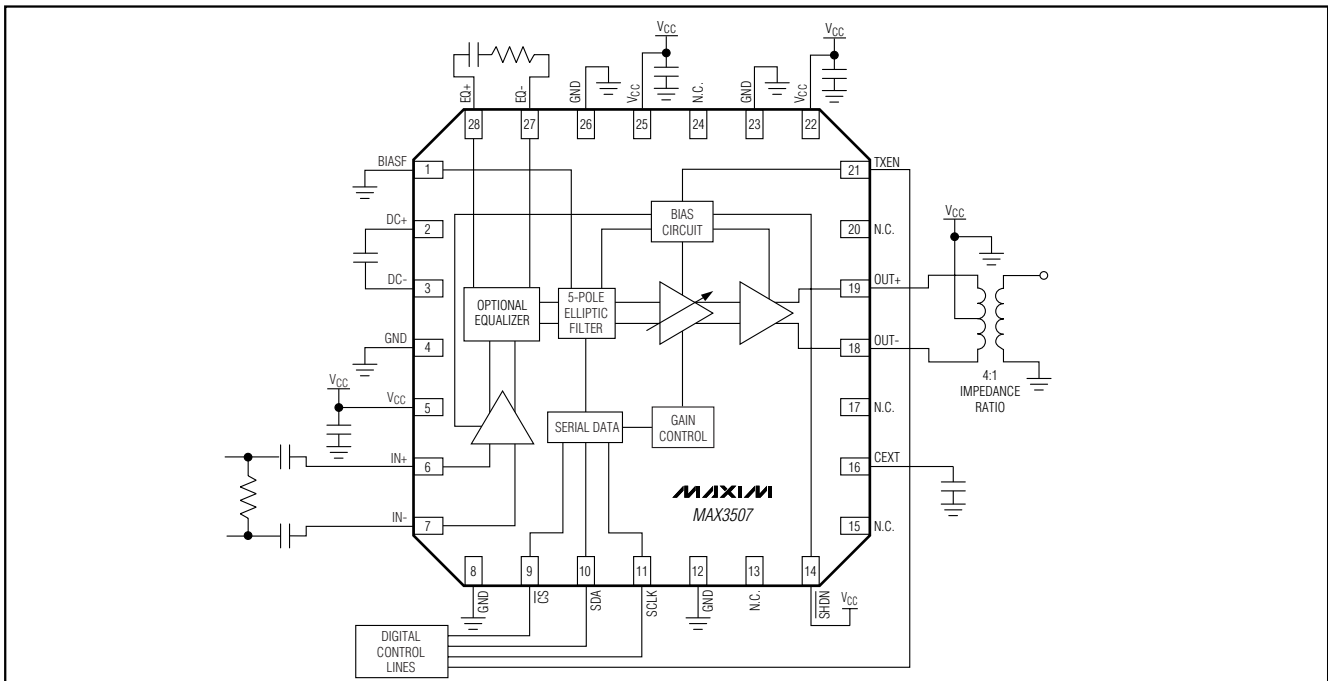

*SPI is a trademark of Motorola, Inc.*

**MAXIM**

Maxim Integrated Products 1

**For pricing, delivery, and ordering information, please contact Maxim/Dallas Direct! at 1-888-629-4642, or visit Maxim's website at [www.maxim-ic.com](http://www.maxim-ic.com).**

# Upstream CATV Amplifier with On-Chip Anti-Alias Filter

## ABSOLUTE MAXIMUM RATINGS

V <sub>CC</sub> , OUT+, OUT- to GND.....	-0.5V to +8.0V	Operating Temperature Range .....	-40°C to +85°C
Input Voltage Levels (all inputs), C <sub>EXT</sub> to GND .....	-0.3V to (V <sub>CC</sub> + 0.3V)	Junction Temperature .....	+150°C
Continuous Input Voltage (IN+, IN-) .....	2Vp-p	Storage Temperature Range .....	-65°C to +125°C
Continuous Current (OUT+, OUT-) .....	120mA	Bump Reflow Temperature .....	+300°C
Continuous Power Dissipation (T <sub>A</sub> = +70°C) 28-Pin QFN (derate 20.8mW/°C above +70°C) .....	1.67W		

Stresses beyond those listed under "Absolute Maximum Ratings" may cause permanent damage to the device. These are stress ratings only, and functional operation of the device at these or any other conditions beyond those indicated in the operational sections of the specifications is not implied. Exposure to absolute maximum rating conditions for extended periods may affect device reliability.

## DC ELECTRICAL CHARACTERISTICS

(MAX3507 EV Kit, V<sub>CC</sub> = +4.75V to +5.25V, V<sub>GND</sub> = 0, V<sub>TXEN</sub> = V<sub>SHDN</sub> = V<sub>CC</sub>, D7 = 1, T<sub>A</sub> = -40°C to +85°C, unless otherwise specified. No input signal applied. A 4:1 (300Ω to 75Ω) impedance ratio balun is connected to differential output ports and balun output is terminated into a 75Ω load. Typical parameters are at V<sub>CC</sub> = +5.0V, T<sub>A</sub> = +25°C.) (Note 1)

PARAMETER	CONDITIONS	MIN	TYP	MAX	UNITS
Supply Voltage		4.75		5.25	V
Supply Current Transmit Mode	D7 = 1, gain code = 127 (max gain)		218	280	mA
	D7 = 1, gain code = 119 (gain of 28dB)		164		
	D7 = 1, gain code = 64 (gain of 0dB)		82		
	D7 = 0, gain code = 94 (gain of 0dB)		74		
Supply Current Transmit Disable Mode	V <sub>TXEN</sub> = V <sub>EE</sub> , V <sub>SHDN</sub> = V <sub>CC</sub>		45	59	mA
Shutdown Supply Current	V <sub>TXEN</sub> = X, V <sub>SHDN</sub> = V <sub>EE</sub>		1		μA
<b>LOGIC INPUTS</b>					
Input HIGH Voltage Threshold		2.0			V
Input LOW Voltage Threshold				0.8	V
Input HIGH Current				100	μA
Input LOW Current		-100			μA

# Upstream CATV Amplifier with On-Chip Anti-Alias Filter

MAX3507

## AC ELECTRICAL CHARACTERISTICS

(MAX3507 EV Kit,  $V_{CC} = +4.75V$  to  $+5.25V$ ,  $V_{GND} = 0$ ,  $V_{TXEN} = \overline{VSHDN} = V_{CC}$ ,  $V_{IN} = +34dBmV$  differential,  $T_A = -40^{\circ}C$  to  $+85^{\circ}C$ , unless otherwise specified. A 4:1 impedance ratio ( $300\Omega$  to  $75\Omega$ ) balun is connected to differential output ports and balun output is terminated into a  $75\Omega$  load. Typical parameters are at  $V_{CC} = +5.0V$ ,  $T_A = +25^{\circ}C$ .) (Note 1)

PARAMETER	CONDITIONS	MIN	TYP	MAX	UNITS	
Voltage Gain ( $A_V$ )	$f_{IN} = 5MHz$ , $T_A = 0^{\circ}C$ to $+85^{\circ}C$ (Note 2)	D7 = 1, gain code = 125	29.6	31.1	32.6	dB
		D7 = 1, gain code = 119	26.8	28.3	29.8	
		D7 = 1, gain code = 104	19.5	20.9	22.3	
		D7 = 1, gain code = 84	9.7	10.9	12.1	
		D7 = 1, gain code = 64	-0.7	0.5	1.7	
		D7 = 0, gain code = 74	-10.5	-9.3	-8.1	
		D7 = 0, gain code = 54	-20.4	-19.1	-17.8	
	$f_{IN} = 65MHz$ , $T_A = 0^{\circ}C$ to $+85^{\circ}C$ (Note 3)	D7 = 1, gain code = 127	29.0			
Gain Flatness	$V_{OUT} = 61dBmV$ , $f_{IN} = 42MHz$ , equalizer disabled (Note 3)	-1.1	-0.5	+0.2	dB	
	$V_{OUT} = 61dBmV$ , $f_{IN} = 65MHz$ , equalizer disabled (Note 3)	-2.1	-0.7	+0.3		
Gain Step Size	$f_{IN} = 5MHz$ to $65MHz$ , $A_V = -26dB$ to $+30dB$		0.5		dB	
	$f_{IN} = 5MHz$ to $65MHz$ , $A_V = -26dB$ to $+30dB$ , any 2-bit transition of D0, D1	0.7	1.0	1.3		
	$f_{IN} = 5MHz$ to $42MHz$ , D7 = 0, gain code = 109; D7 = 1, gain code = 81, $T_A = 0^{\circ}C$ to $+85^{\circ}C$	0.6	1.0	1.4		
Transmit-Disable Mode Noise	Any BW = 160kHz from 5MHz to 65MHz, $TXEN = V_{EE}$ (Note 3)			-64	dBmV	
Isolation in Transmit Disable Mode	$TXEN = V_{EE}$ , $f_{IN} = 5MHz$ to $65MHz$		70		dB	
Transmit Mode Noise	Any BW = 160kHz from 5MHz to 65MHz, gain = $-26dB$ to $+30dB$ (Note 3)			-54.5	dBc	
Transmit Enable Transient Duration	$TXEN$ input rise/fall time $< 0.1\mu s$ , $T_A = +25^{\circ}C$ (Notes 3, 4)			2	$\mu s$	
Transmit Disable Transient Duration	$TXEN$ input rise/fall time $< 0.1\mu s$ , $T_A = +25^{\circ}C$ (Notes 3, 4)			2	$\mu s$	
Transmit Disable/Transmit Enable Transient Step Size	D7 = 1, gain code = 119 ( $A_V = >27dB$ ), $T_A = +25^{\circ}C$			100	mVp-p	
	D7 = 0, gain code = 94 ( $A_V = 0$ ), $T_A = +25^{\circ}C$ (Note 3)		1.5	5.2		
Input Impedance	$f_{IN} = 5MHz$ to $65MHz$ , single ended (Note 3)	0.8			k $\Omega$	
Output Return Loss	$f_{IN} = 5MHz$ to $42MHz$ in $75\Omega$ system, D7 = 1, gain code = 125 ( $A_V = 30dB$ ) (Note 5)		10		dB	
Output Return Loss in Transmit Disable Mode	$f_{IN} = 5MHz$ to $42MHz$ in $75\Omega$ system, $TXEN = V_{EE}$ (Note 5)		10		dB	

# Upstream CATV Amplifier with On-Chip Anti-Alias Filter

## AC ELECTRICAL CHARACTERISTICS (continued)

(MAX3507 EV Kit,  $V_{CC} = +4.75V$  to  $+5.25V$ ,  $V_{GND} = 0$ ,  $V_{TXEN} = \overline{V_{SHDN}} = V_{CC}$ ,  $V_{IN} = +34dBmV$  differential,  $T_A = -40^{\circ}C$  to  $+85^{\circ}C$ , unless otherwise specified. A 4:1 impedance ratio ( $300\Omega$  to  $75\Omega$ ) balun is connected to differential output ports and balun output is terminated into a  $75\Omega$  load. Typical parameters are at  $V_{CC} = +5.0V$ ,  $T_A = +25^{\circ}C$ .) (Note 1)

PARAMETER	CONDITIONS	MIN	TYP	MAX	UNITS
Two-Tone Third-Order Distortion	Input tones at 42MHz and 42.2MHz, both at +31dBmV, $V_{OUT} = +58dBmV$ /tone		-55.4		dBc
	Input tones at 65MHz and 65.2MHz, both at +31dBmV, $V_{OUT} = +58dBmV$ /tone		-47.6		
2 <sup>ND</sup> Harmonic Distortion	$f_{IN} = 33MHz$ , $V_{OUT} = +63dBmV$		-58		dBc
	$f_{IN} = 33MHz$ , $V_{OUT} = +60dBmV$ , $T_A = 0^{\circ}C$ to $+85^{\circ}C$		-56	-50	
	$f_{IN} = 65MHz$ , $V_{OUT} = +60dBmV$		-61		
3 <sup>RD</sup> Harmonic Distortion	$f_{IN} = 22MHz$ , $V_{OUT} = +63dBmV$		-53		dBc
	$f_{IN} = 22MHz$ , $V_{OUT} = +60dBmV$		-58	-51	
	$f_{IN} = 65MHz$ , $V_{OUT} = +60dBmV$		-57		
1dB Compression Point	Gain = 26dB, $f_{IN} = 65MHz$		22		dBm
AM to AM	Gain = 28dB, $V_{IN} = +34dBmV$ to $+38dBmV$ , $f_{IN} = 65MHz$		-0.1		dB
AM to PM	Gain = 28dB, $V_{IN} = +34dBmV$ to $+38dBmV$ , $f_{IN} = 65MHz$		-1.3		degrees
Rejection at 135MHz	Referenced to 65MHz	36	47		dBc

## TIMING CHARACTERISTICS

(MAX3507 EV Kit,  $V_{CC} = +4.75V$  to  $+5.25V$ ,  $V_{GND} = 0$ ,  $V_{TXEN} = \overline{V_{SHDN}} = V_{CC}$ ,  $T_A = +25^{\circ}C$ , unless otherwise specified.) (Note 3)

PARAMETER	SYMBOL	CONDITIONS	MIN	TYP	MAX	UNITS
SEN to SCLK Rise Set Time	$t_{SENS}$		20			ns
SEN to SCLK Rise Hold Time	$t_{SENH}$		10			ns
SDA to SCLK Setup Time	$t_{SDAS}$		10			ns
SDA to SCLK Hold Time	$t_{SDAH}$		20			ns
SDA Pulse-Width High	$t_{DATAH}$		50			ns
SDA Pulse-Width Low	$t_{DATA L}$		50			ns
SCLK Pulse-Width High	$t_{SCLKH}$		50			ns
SCLK Pulse-Width Low	$t_{SCLKL}$		50			ns

**Note 1:** Guaranteed by design and characterization to  $\pm 3$  sigma for  $T_A < +25^{\circ}C$ , unless otherwise specified.

**Note 2:** AC gain correlated to DC gain measurements to  $\pm 3$  sigma.

**Note 3:** Guaranteed by design and characterization to  $\pm 6$  sigma.

**Note 4:** All transients comply with DOCSIS 1.1 limits for transmit power ripple of  $\pm 0.1dB$ .

**Note 5:** Does not include output matching; see *Output Match* in the *Applications* section.

# Upstream CATV Amplifier with On-Chip Anti-Alias Filter

## Typical Operating Characteristics

(MAX3507 EV Kit,  $V_{CC} = +5.0V$ ,  $V_{IN} = +34dBmV$ ,  $TXEN = \overline{SHDN} = V_{CC}$ ,  $f_{IN} = 20MHz$ ,  $T_A = +25^\circ C$ , unless otherwise noted.)

MAX3507

**SUPPLY CURRENT vs. TEMPERATURE**

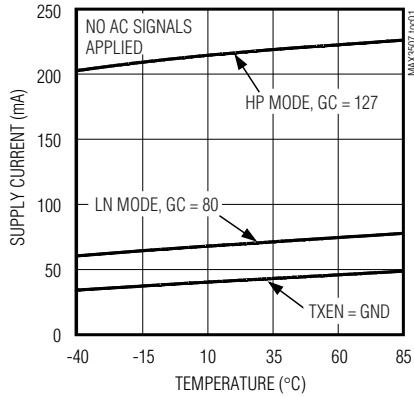

**SUPPLY CURRENT IN HIGH-POWER MODE vs. OUTPUT POWER**

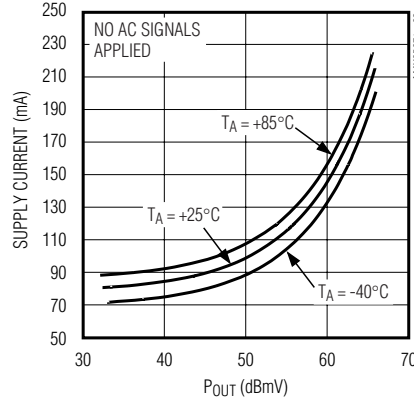

**SUPPLY CURRENT IN LOW-NOISE MODE vs. OUTPUT POWER**

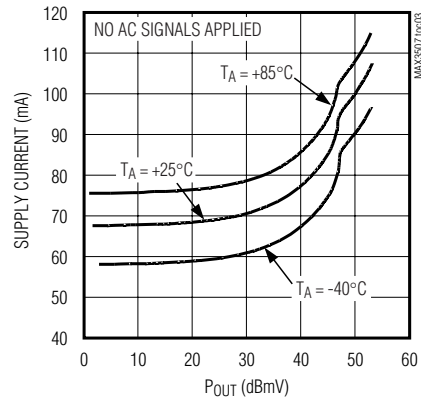

**VOLTAGE GAIN IN HIGH-POWER MODE vs. TEMPERATURE**

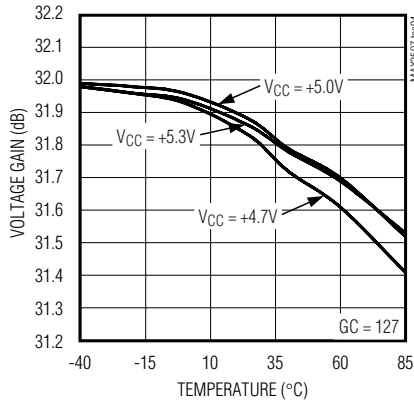

**VOLTAGE GAIN IN LOW-NOISE MODE vs. TEMPERATURE**

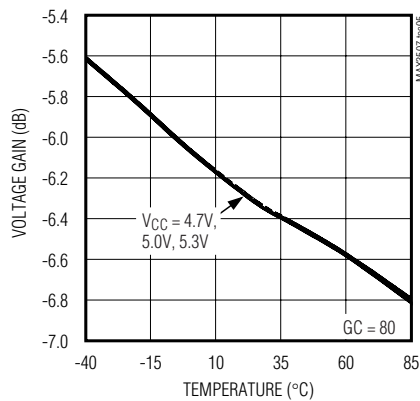

**VOLTAGE GAIN IN HIGH-POWER MODE vs. FREQUENCY**

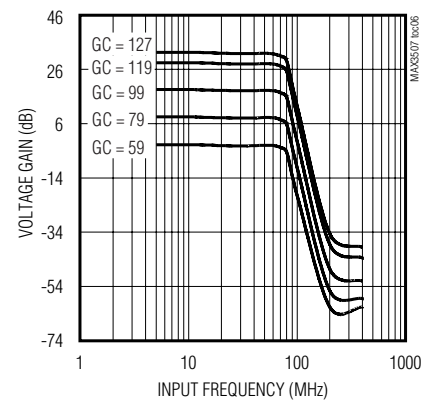

**VOLTAGE GAIN IN LOW-NOISE MODE vs. FREQUENCY**

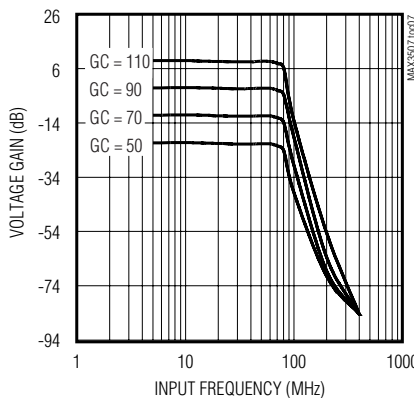

**VOLTAGE GAIN vs. GAIN CODE**

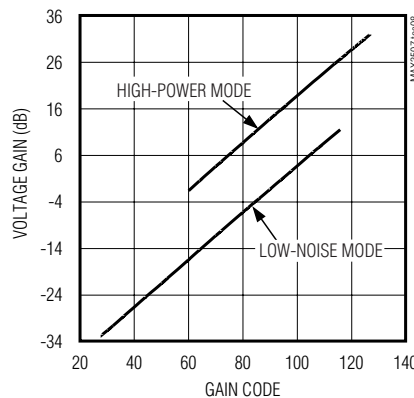

**GAIN STEP IN HIGH-POWER MODE vs. GAIN CODE**

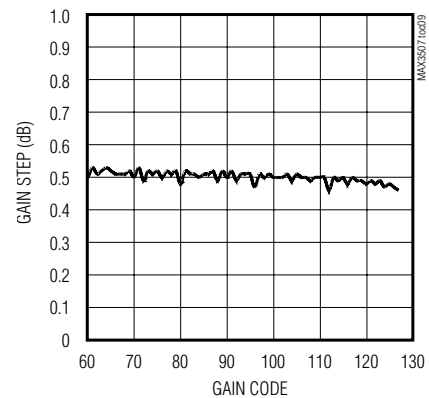

# Upstream CATV Amplifier with On-Chip Anti-Alias Filter

## Typical Operating Characteristics (continued)

(MAX3507 EV Kit,  $V_{CC} = +5.0V$ ,  $V_{IN} = +34dBmV$ ,  $TXEN = SHDN = V_{CC}$ ,  $f_{IN} = 20MHz$ ,  $T_A = +25^\circ C$ , unless otherwise noted.)

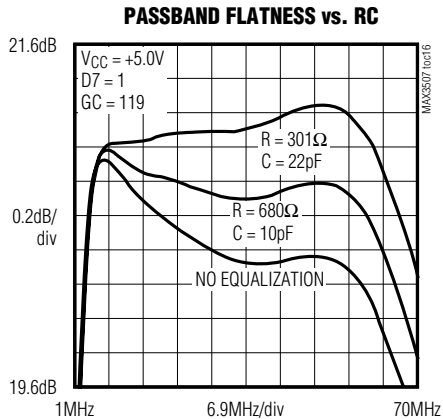
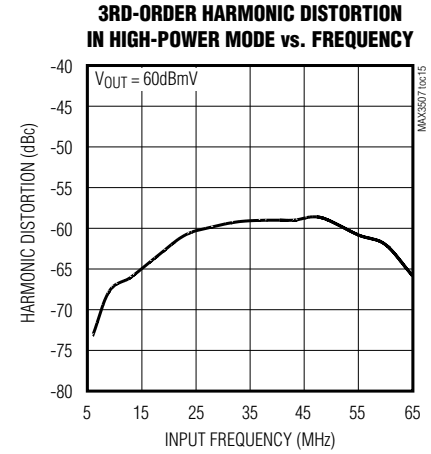
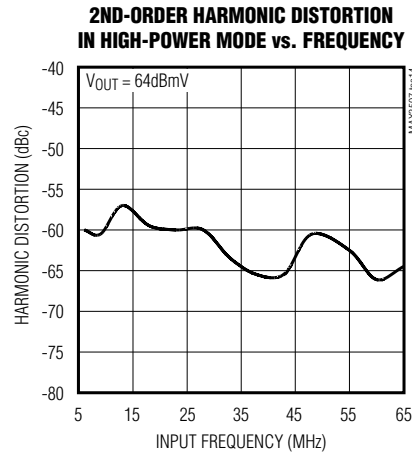
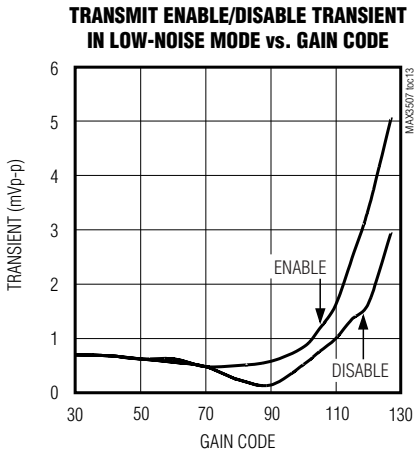
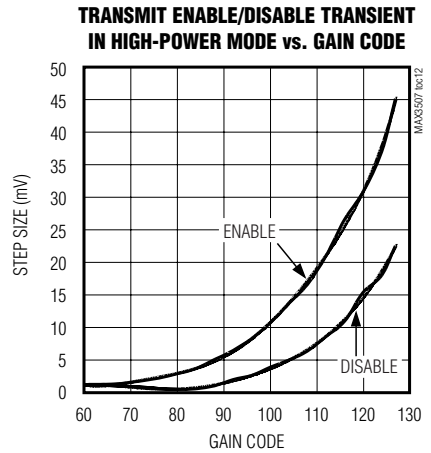
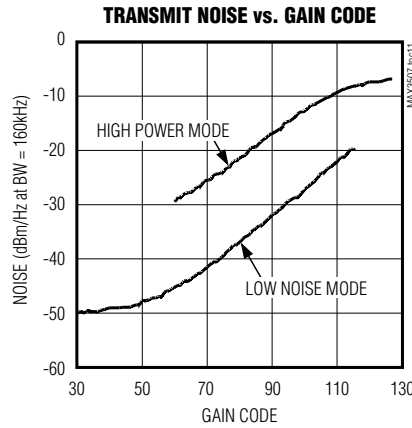
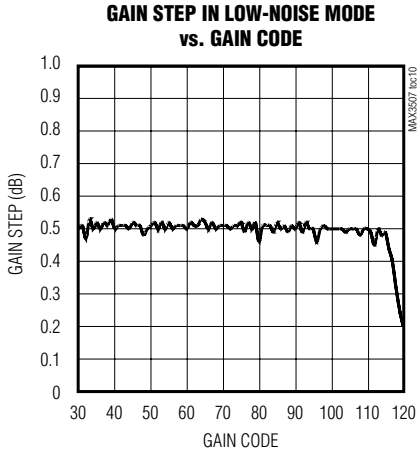

# Upstream CATV Amplifier with On-Chip Anti-Alias Filter

MAX3507

## Pin Description

PIN	NAME	DESCRIPTION
1	BIASF	Filter Bias. Connect to GND.
2	DC+	Filter Offset Correction. Connect 0.1μF capacitor between this pin and DC-.
3	DC-	Filter Offset Correction. Connect 0.1μF capacitor between this pin and DC+.
4, 8, 12, 23, 26	GND	Ground
5, 22, 25	VCC	+5V Supply. Bypass this pin to GND with a 0.1μF capacitor as close to the part as possible.
6	IN+	Positive Input. Along with IN-, this port forms a high-impedance differential input to the filter.
7	IN-	Negative Input. When not used, this port must be AC-coupled to ground. See IN+.
9	$\overline{\text{CS}}$	Serial Interface Enable (Chip Select). TTL-compatible input. See <i>Serial Interface</i> section.
10	SDA	Serial Interface Data (Serial Data). TTL-compatible input. See <i>Serial Interface</i> section.
11	SCLK	Serial Interface Clock (Serial Clock). TTL-compatible input. See <i>Serial Interface</i> section.
13, 15, 17, 20, 24	N.C.	No Connection. Not internally connected.
14	$\overline{\text{SHDN}}$	Shutdown. When $\overline{\text{SHDN}}$ is set low, all functions (including the serial interface) are disabled.
16	CEXT	RF Output Bypass. Bypass to ground with a 0.1μF capacitor.
18	OUT-	Negative Output. Along with OUT+, this port forms a 300Ω impedance output. This port is matched to a 75Ω load using a 2:1 (voltage ratio) transformer.
19	OUT+	Positive Output. See OUT-.
21	TXEN	Signal Path Enable. Setting this pin low turns off the PGA and power amplifier, leaving the filter and serial interface enabled to save the last gain setting.
27	EQ+	Positive Equalizer. Connect an RC network if equalization of the filter passband is desired; leave open otherwise. See <i>Typical Operating Characteristics</i> .
28	EQ-	Negative Equalizer. Connect an RC network if equalization of the filter passband is desired; leave open otherwise. See <i>Typical Operating Characteristics</i> .

## Detailed Description

### Internal Filter

The internal filter consists of an input transconductance amplifier, a balanced fifth-order elliptic active lowpass filter, and an offset-correction feedback network. The signal at the output of the filter is level-shifted into the programmable-gain amplifier.

The transconductance amplifier provides a high input impedance to the user, and current drives the filter to minimize insertion loss. The filter is a Gm-C topology to provide sufficient bandwidth and linearity. The cutoff frequency of the filter is fixed at 75MHz, while the specified stopband attenuation is met at 120MHz.

The internal offset-correction feedback network removes any DC offset at the output of the filter. An offset voltage at this node would generate a transient during a TX-enable or -disable transition, which would not be acceptable. The offset-correction loop effectively AC-couples the filter output to the programmable-gain

amplifier input. The network generates a highpass corner frequency at:

$$f_{-3\text{dB}}(\text{kHz}) = 12.5/C(\mu\text{F})$$

Specified performance is achieved when the input is driven differentially. The MAX3507 may be driven single-ended. To drive the device in this manner, one of the input pins must be capacitively coupled to ground. Use a capacitor whose value is large enough to allow for a low-impedance path to ground at the lowest frequency of operation. For operation down to 5MHz, a 0.001μF capacitor is suggested.

### Programmable-Gain Amplifier

The programmable-gain amplifier (PGA) consists of the variable-gain amplifier (VGA) and the digital-to-analog converter (DAC), which provide better than 55dB of output-level control in 0.5dB steps. The PGA is implemented as a programmable Gilbert-cell attenuator. It uses a differential architecture to achieve maximum linearity. The gain of the PGA is determined by a 7-bit



# Upstream CATV Amplifier with On-Chip Anti-Alias Filter

word (D6–D0) programmed through the serial data interface (Tables 1 and 2).

## Equalizer Function

It is possible to add passband amplitude equalization to the MAX3507. This is accomplished by adding pole-zero peaking to the Gm stage of the PGA. Placing a series RC network between pins EQ+ and EQ- realizes the peaking function. Refer to *Typical Operating Characteristics* for typical values and the associated degree of equalization.

## Power Amplifier

The power amplifier is a Class A differential amplifier capable of driving +64dBmV (QPSK) differentially. This architecture provides superior even-order distortion performance but requires that a transformer be used to convert to a single-ended output. In transmit-disable mode, the output amplifier is shut off. Disabling the output devices also allows the lowest standby noise.

To achieve the proper load line, the output impedance of the power amplifier is 300Ω differential. To match the output impedance to a 75Ω load, the transformer must have a turns ratio (voltage ratio) of 2:1 (4:1 impedance ratio). The differential amplifier is biased directly from the +5V supply using the center tap of the output transformer. This provides a significant benefit when switching between transmit mode and transmit disable mode. Stored energy due to bias currents will cancel within the transformer and prevent switching transients from reaching the load.

## Serial Interface

The serial interface has an active-low enable ( $\overline{CS}$ ) to bracket the data, with data clocked in MSB first on the rising edge of SCLK. Data is stored in the storage latch on the rising edge of  $\overline{CS}$ . The serial interface controls the gain state of the PGA and the output amplifier. Tables 1 and 2 show the register format. Serial interface timing is shown in Figure 1.

## Applications Information

### Transmit High-Power and Low-Noise Modes

The MAX3507 has two transmit modes, high-power (HP) mode and low-noise (LN) mode. Each of these modes is controlled by D7 (MSB) of the 8-bit programming word. When D7 is a logical 1, HP mode is enabled. When D7 is a logical 0, LN mode is enabled.

Each of these modes is characterized by the activation of a distinct output stage. In HP mode, the output stage exhibits a gain that is 15dB higher than gain in LN mode. In LN mode, the lower gain output stage allows

**Table 1. Serial-Interface Control Word**

BIT	MNEMONIC	DESCRIPTION
7 (MSB)	D7	High-Power/Low-Noise Mode Select
6	D6	Gain Code, Bit 6
5	D5	Gain Code, Bit 5
4	D4	Gain Code, Bit 4
3	D3	Gain Code, Bit 3
2	D2	Gain Code, Bit 2
1	D1	Gain Code, Bit 1
0 (LSB)	D0	Gain Code, Bit 0

for significantly lower output noise and lower transmit/transmit disable transients.

The full range of gain codes (D6–D0) may be used in either mode. For DOCSIS applications, HP mode is recommended for output levels at or above +42dBmV, and LN mode is recommended for output levels below +42dBmV.

## Shutdown Mode

In normal operation, the shutdown pin (SHDN) is held high. When  $\overline{SHDN}$  is set low, all circuits within the device are disabled. Only leakage currents flow in this state. Data stored within the serial data interface latches will be lost upon entering this mode. Current consumption is reduced to 1μA (typ) in shutdown mode.

## Output Match

The MAX3507 output impedance is internally matched to 300Ω. This 300Ω internal resistor is placed across the OUT+ and OUT- terminals. When used in conjunction with a 2:1 (voltage ratio) transformer, the MAX3507 output impedance is matched to 75Ω.

To improve the output impedance matching for the high-end frequency range (65MHz), a reactive match may be employed as part of the ensuing diplex filter. The reactive match normally consists of a series inductor (180nH typ) followed by a shunt capacitor (33pF typ), and is placed directly after the output transformer. This match will also improve the gain flatness substantially.

As mentioned above, the matching components may be incorporated into the diplex filter design. Optimize the input impedance of the diplex filter to be 35 + j35 (typ) at 65MHz when using the specified output transformer.

## Transformer

To match the output of the MAX3507 to a 75Ω load, a 2:1 (voltage ratio) transformer is required. This trans-



# Upstream CATV Amplifier with On-Chip Anti-Alias Filter

MAX3507

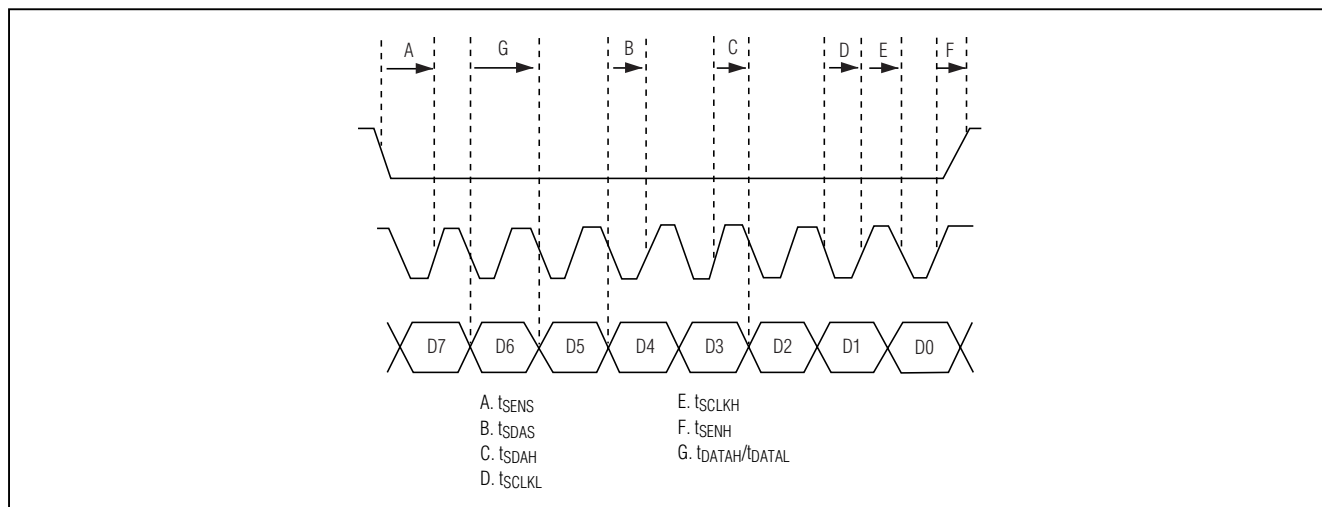

Figure 1. Serial Interface Timing Diagram

Table 2. Chip-State Control Bits

$\overline{\text{SHDN}}$	TXEN	D7	D6	D5	D4	D3	D2	D1	D0	GAIN STATE (DECIMAL)	GAIN (dB)	STATES
0	X	X	X	X	X	X	X	X	X	—	—	Shutdown
1	0	X	X	X	X	X	X	X	X	—	—	Transmit Disable Mode
1	1	1	X	X	X	X	X	X	X	—	—	Transmit Enable Mode, High Power
1	1	0	X	X	X	X	X	X	X	—	—	Transmit Enable Mode, Low Noise
1	1	0	0	1	1	0	0	0	0	48	-22.6	—
1	1	0	1	0	1	0	0	0	0	80	-6.29	—
1	1	0	1	1	0	1	1	1	0	110	8.68	—
1	1	1	1	0	1	0	1	1	0	86	11.69	—
1	1	1	1	1	0	1	1	1	0	110	23.7	—
1	1	1	1	1	1	1	1	0	1	125	31.0	—

Typical gain at  $T_A = +25^\circ\text{C}$  and  $V_{CC} = +5\text{V}$ .

former must have adequate bandwidth to cover the intended application. Note that most RF transformers specify bandwidth with a  $50\Omega$  source on the primary and a matching resistance on the secondary winding. Operating in a  $75\Omega$  system will tend to shift the low-frequency edge of the transformer bandwidth specification up by a factor of 1.5, due to primary inductance. Keep this in mind when specifying a transformer.

Bias to the output stage is provided through the center tap on the transformer primary. This greatly diminishes

the on/off transients present at the output when switching between transmit and transmit disable modes. Commercially available transformers typically have adequate balance between half-windings to achieve substantial transient cancellation.

Finally, keep in mind that transformer core inductance varies proportionally with temperature. If the application requires low temperature extremes (less than  $0^\circ\text{C}$ ), adequate primary inductance must be present to sustain low-frequency output capability as temperatures





# Upstream CATV Amplifier with On-Chip Anti-Alias Filter

## Package Information (continued)

### NOTES:

1. DIE THICKNESS ALLOWABLE IS 0.305mm MAXIMUM (.012 INCHES MAXIMUM)
2. DIMENSIONING & TOLERANCES CONFORM TO ASME Y14.5M. - 1994.
3. N IS THE NUMBER OF TERMINALS.  
Nd IS THE NUMBER OF TERMINALS IN X-DIRECTION &  
Ne IS THE NUMBER OF TERMINALS IN Y-DIRECTION.
4. DIMENSION b APPLIES TO PLATED TERMINAL AND IS MEASURED BETWEEN 0.20 AND 0.25mm FROM TERMINAL TIP.
5. THE PIN #1 IDENTIFIER MUST BE EXISTED ON THE TOP SURFACE OF THE PACKAGE BY USING INDENTATION MARK OR INK/ LASER MARKED.
6. EXACT SHAPE AND SIZE OF THIS FEATURE IS OPTIONAL.
7. ALL DIMENSIONS ARE IN MILLIMETERS.
8. PACKAGE WARPAGE MAX 0.05mm.
9. APPLIED FOR EXPOSED PAD AND TERMINALS.  
EXCLUDE EMBEDDED PART OF EXPOSED PAD FROM MEASURING.
10. MEETS JEDEC MO220.
11. THIS PACKAGE OUTLINE APPLIES TO ANVIL SINGULATION (STEPPED SIDES) AND TO SAW SINGULATION (STRAIGHT SIDES) QFN STYLES.

SYMBOL	COMMON DIMENSIONS			NOTE
	MIN.	NOM.	MAX.	
A	0.80	0.90	1.00	
A1	0.00	0.01	0.05	
A2	0.00	0.65	1.00	
A3	0.20 REF.			
D	5.00 BSC			
D1	4.75 BSC			
E	5.00 BSC			
E1	4.75 BSC			
θ	0°	-	12°	
P	0	-	0.60	
D2	1.25	-	3.25	
E2	1.25	-	3.25	

SYMBOL	PITCH VARIATION B			NOTE	SYMBOL	PITCH VARIATION B			NOTE	SYMBOL	PITCH VARIATION C			NOTE	SYMBOL	PITCH VARIATION D			NOTE
	MIN.	NOM.	MAX.			MIN.	NOM.	MAX.			MIN.	NOM.	MAX.			MIN.	NOM.	MAX.	
	0.80 BSC					0.65 BSC					0.50 BSC					0.50 BSC			
N	16			3	N	20			3	N	28			3	N	32			3
Nd	4			3	Nd	5			3	Nd	7			3	Nd	8			3
Ne	4			3	Ne	5			3	Ne	7			3	Ne	8			3
L	0.35	0.55	0.75		L	0.35	0.55	0.75		L	0.35	0.55	0.75		L	0.30	0.40	0.50	
b	0.28	0.33	0.40	4	b	0.23	0.28	0.35	4	b	0.18	0.23	0.30	4	b	0.18	0.23	0.30	4

<b>MAXIM</b>			
PROPRIETARY INFORMATION			
TITLE: PACKAGE OUTLINE, 16,20,28,32L QFN, 5x5x0.90 MM			
APPROVAL	DOCUMENT CONTROL NO.	REV	
	21-0091	G	2/2

Maxim cannot assume responsibility for use of any circuitry other than circuitry entirely embodied in a Maxim product. No circuit patent licenses are implied. Maxim reserves the right to change the circuitry and specifications without notice at any time.

12 \_\_\_\_\_ **Maxim Integrated Products, 120 San Gabriel Drive, Sunnyvale, CA 94086 408-737-7600**