

Dual P-Channel 20-V (D-S) MOSFET

PRODUCT SUMMARY		
V_{DS} (V)	$r_{DS(on)}$ (Ω)	I_D (A)
-20	0.051 @ $V_{GS} = -4.5$ V	-5.7
	0.067 @ $V_{GS} = -2.5$ V	-5.0
	0.094 @ $V_{GS} = -1.8$ V	-4.2

FEATURES

- TrenchFET® Power MOSFETS: 1.8-V Rated
- New Low Thermal Resistance PowerPAK® Package

APPLICATIONS

- Portable
 - PA Switch
 - Battery Switch
 - Load Switch

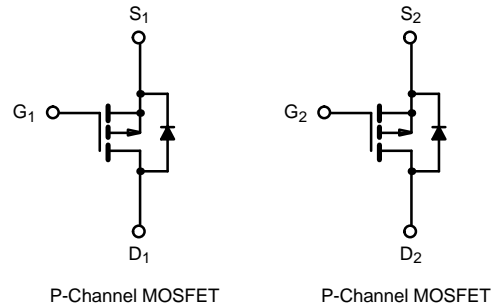
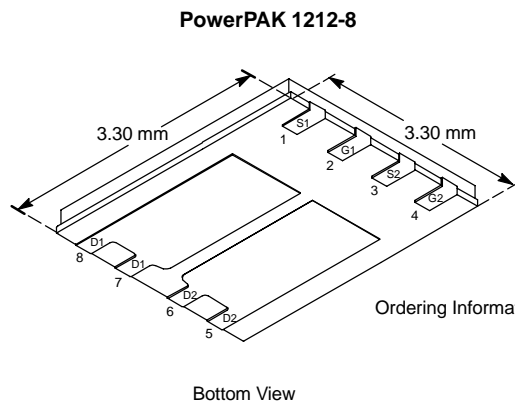

ABSOLUTE MAXIMUM RATINGS ($T_A = 25^\circ\text{C}$ UNLESS OTHERWISE NOTED)					
Parameter	Symbol	10 secs	Steady State	Unit	
Drain-Source Voltage	V_{DS}	-20		V	
Gate-Source Voltage	V_{GS}	± 8			
Continuous Drain Current ($T_J = 150^\circ\text{C}$) ^a	I_D	$T_A = 25^\circ\text{C}$	-5.7	-4.2	A
		$T_A = 85^\circ\text{C}$	-4.1	-3.0	
Pulsed Drain Current	I_{DM}	-20			
continuous Source Current (Diode Conduction) ^a	I_S	-2.1	-1.1		
Maximum Power Dissipation ^a	P_D	$T_A = 25^\circ\text{C}$	2.5	1.3	W
		$T_A = 85^\circ\text{C}$	1.3	0.85	
Operating Junction and Storage Temperature Range	T_J, T_{stg}	-55 to 150		$^\circ\text{C}$	

THERMAL RESISTANCE RATINGS					
Parameter	Symbol	Typical	Maximum	Unit	
Maximum Junction-to-Ambient ^a	R_{thJA}	$t \leq 10$ sec	40	50	$^\circ\text{C/W}$
		Steady State	75	94	
Maximum Junction-to-Case	R_{thJC}	5.6	7		

Notes

a. Surface Mounted on 1" x 1" FR4 Board.

SPECIFICATIONS (T_J = 25 °C UNLESS OTHERWISE NOTED)

Parameter	Symbol	Test Condition	Min	Typ	Max	Unit
Static						
Gate Threshold Voltage	V _{GS(th)}	V _{DS} = V _{GS} , I _D = -250 μA	-0.40		-1.0	V
Gate-Body Leakage	I _{GSS}	V _{DS} = 0 V, V _{GS} = ±8 V			±100	nA
Zero Gate Voltage Drain Current	I _{DSS}	V _{DS} = -16 V, V _{GS} = 0 V			-1	μA
		V _{DS} = -16 V, V _{GS} = 0 V, T _J = 85 °C			-5	
On-State Drain Current ^a	I _{D(on)}	V _{DS} ≤ -5 V, V _{GS} = -4.5 V	-20			A
Drain-Source On-State Resistance ^a	r _{DS(on)}	V _{GS} = -4.5 V, I _D = -5.7 A		0.040	0.051	Ω
		V _{GS} = -2.5 V, I _D = -5.0 A		0.054	0.067	
		V _{GS} = -1.8 V, I _D = -1.1 A		0.075	0.094	
Forward Transconductance ^a	g _{fs}	V _{DS} = -6 V, I _D = -5.7 A		14		S
Diode Forward Voltage ^a	V _{SD}	I _S = -2.3 A, V _{GS} = 0 V		-0.8	-1.2	V
Dynamic^b						
Total Gate Charge	Q _g	V _{DS} = -6 V, V _{GS} = -4.5 V, I _D = -5.7 A		9.5	15	nC
Gate-Source Charge	Q _{gs}			1.6		
Gate-Drain Charge	Q _{gd}			2.5		
Gate Resistance	R _g			7.2		Ω
Turn-On Delay Time	t _{d(on)}	V _{DD} = -10 V, R _L = 10 Ω I _D ≅ -1 A, V _{GEN} = -4.5 V, R _G = 6 Ω		20	30	ns
Rise Time	t _r			35	55	
Turn-Off Delay Time	t _{d(off)}			70	105	
Fall Time	t _f			40	60	
Source-Drain Reverse Recovery Time	t _{rr}		I _F = -2.1 A, di/dt = 100 A/μs		25	

Notes

- a. Pulse test; pulse width ≤ 300 μs, duty cycle ≤ 2%.
b. Guaranteed by design, not subject to production testing.

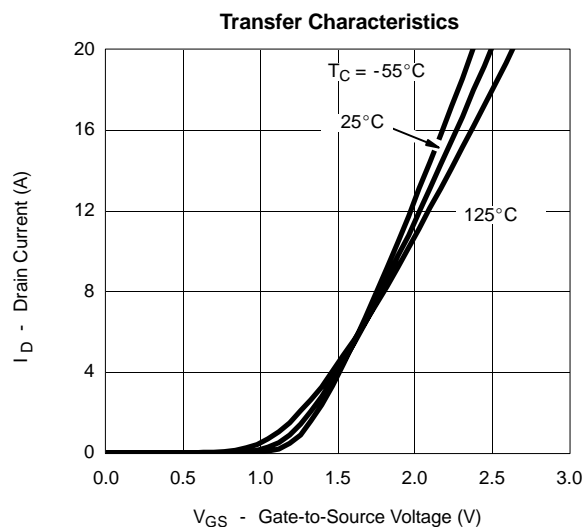
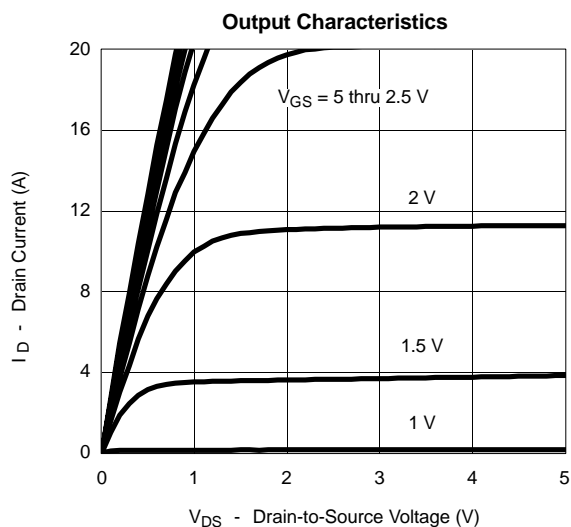
TYPICAL CHARACTERISTICS (25 °C UNLESS NOTED)

TYPICAL CHARACTERISTICS (25 °C UNLESS NOTED)

On-Resistance vs. Drain Current

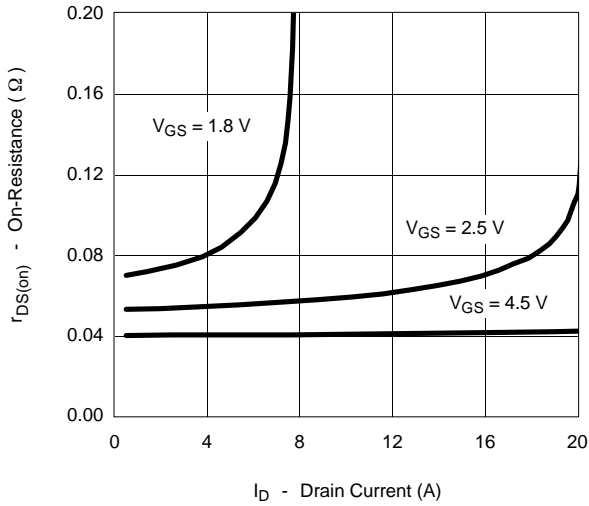

Capacitance

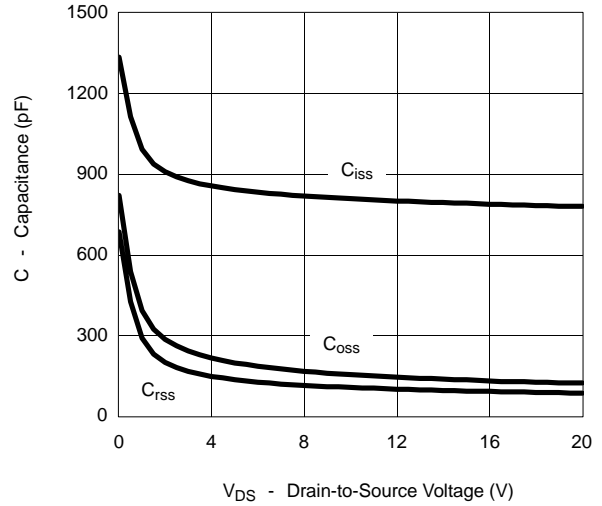

Gate Charge

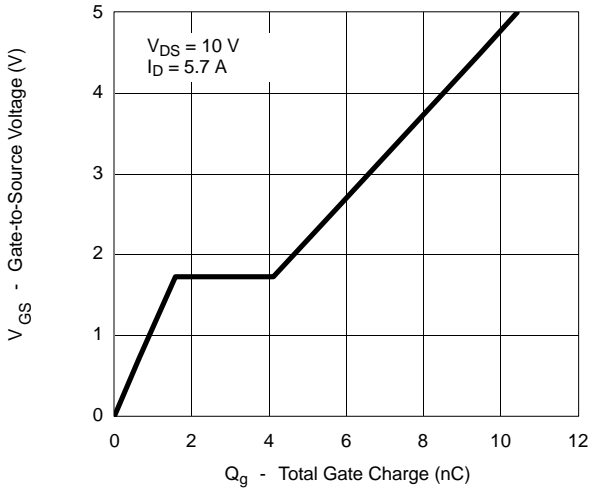

On-Resistance vs. Junction Temperature

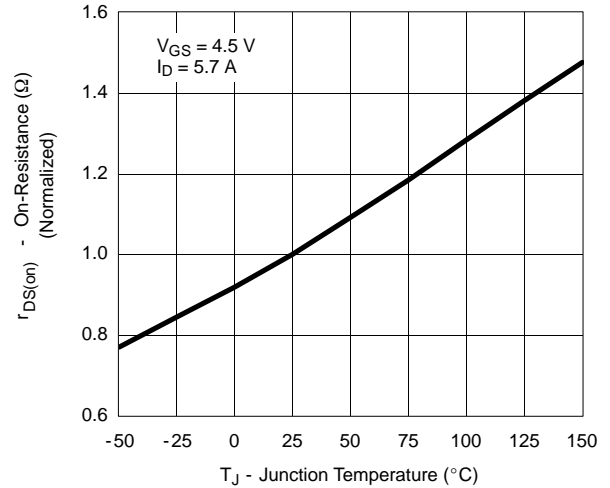

Source-Drain Diode Forward Voltage

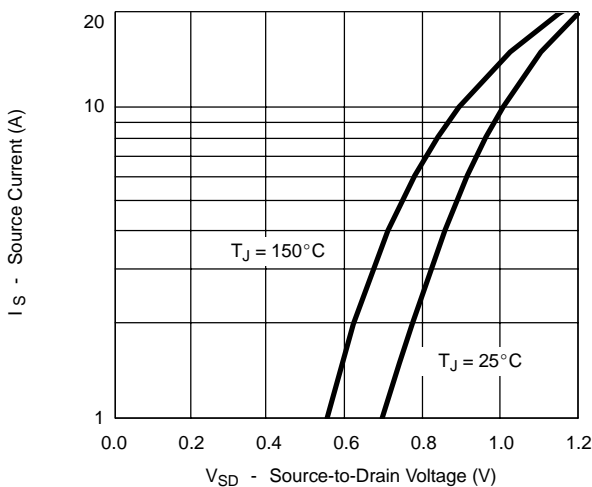

On-Resistance vs. Gate-to-Source Voltage

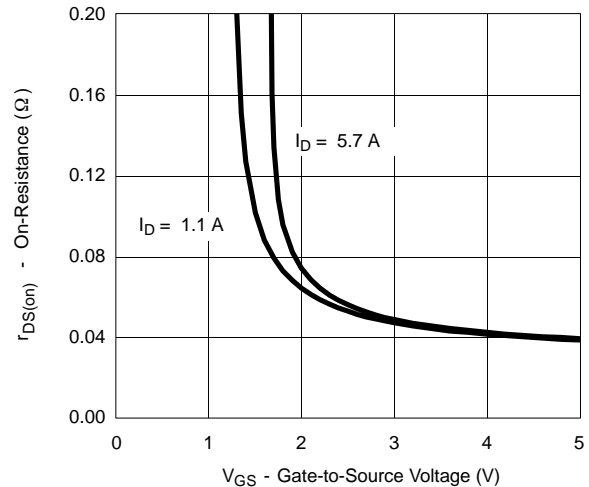

TYPICAL CHARACTERISTICS (25 °C UNLESS NOTED)

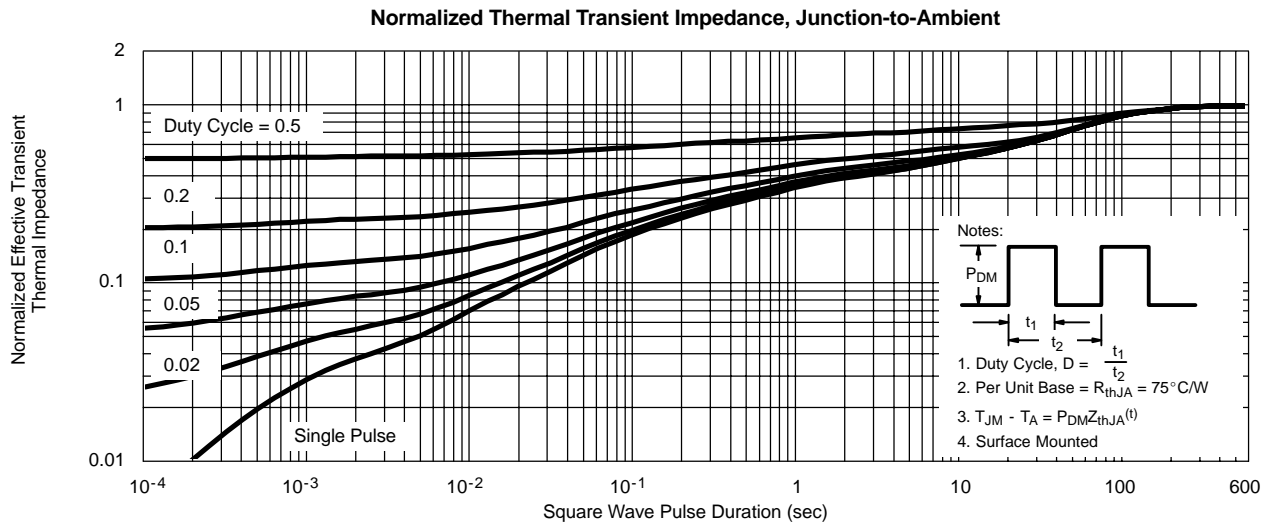
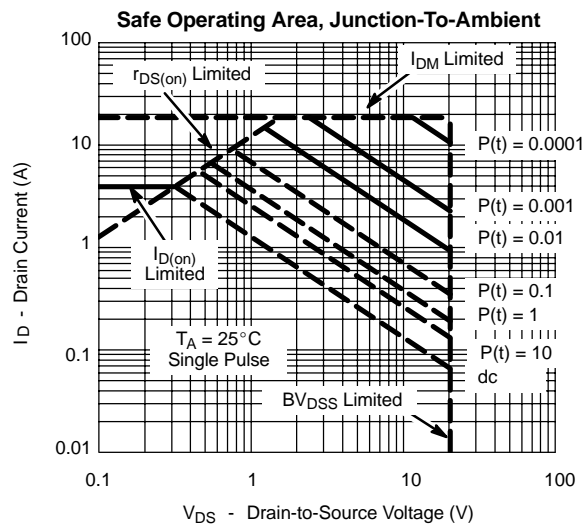
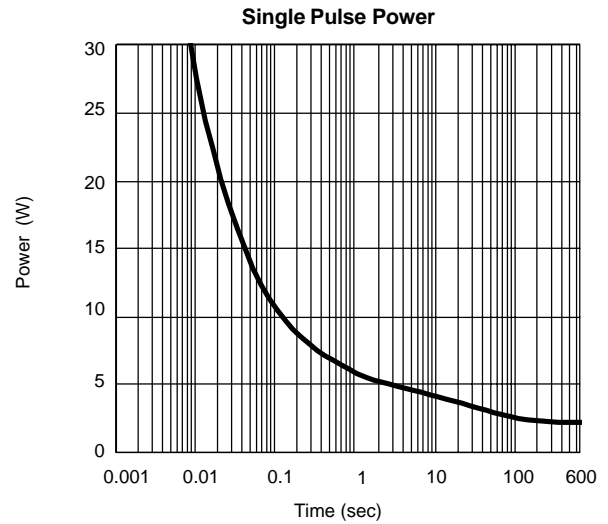
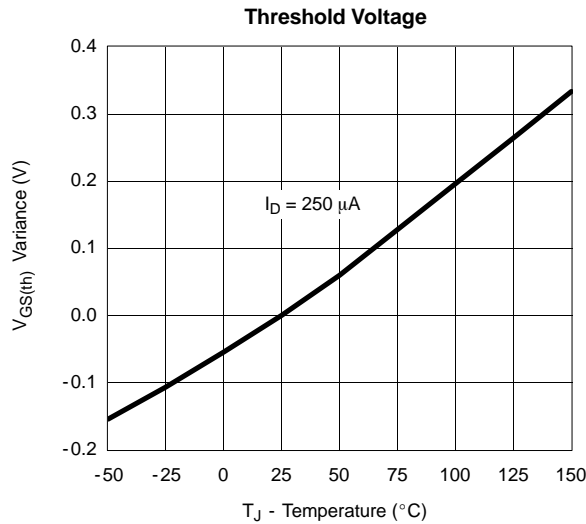



TYPICAL CHARACTERISTICS (25 °C UNLESS NOTED)

