

P-Channel 12-V (D-S) MOSFET

PRODUCT SUMMARY		
V_{DS} (V)	$r_{DS(on)}$ (Ω)	I_D (A)
-12	0.0065 @ $V_{GS} = -4.5$ V	-21
	0.008 @ $V_{GS} = -2.5$ V	-19
	0.011 @ $V_{GS} = -1.8$ V	-16

FEATURES

- TrenchFET® Power MOSFET
- New Low Thermal Resistance PowerPAK® Package with Low 1.07-mm Profile

APPLICATIONS

- Load Switch

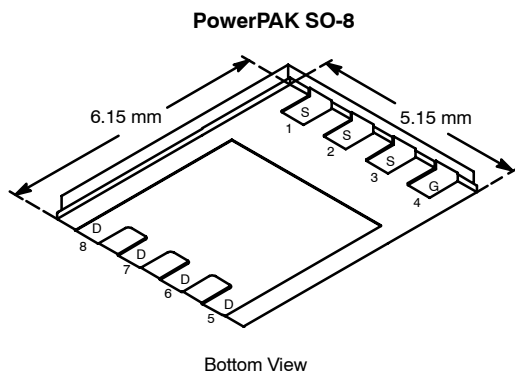

Ordering Information: Si7495DP-T1

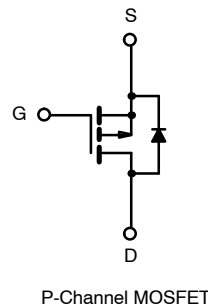

ABSOLUTE MAXIMUM RATINGS ($T_A = 25^\circ\text{C}$ UNLESS OTHERWISE NOTED)					
Parameter	Symbol	10 secs	Steady State	Unit	
Drain-Source Voltage	V_{DS}	-12		V	
Gate-Source Voltage	V_{GS}	± 8			
Continuous Drain Current ($T_J = 150^\circ\text{C}$) ^a	I_D	$T_A = 25^\circ\text{C}$	-21	-13	A
		$T_A = 70^\circ\text{C}$	-17	-10	
Pulsed Drain Current	I_{DM}	-50			
continuous Source Current (Diode Conduction) ^a	I_S	-4.5	-1.6		
Maximum Power Dissipation ^a	P_D	$T_A = 25^\circ\text{C}$	5	1.8	W
		$T_A = 70^\circ\text{C}$	3.2	1.1	
Operating Junction and Storage Temperature Range	T_J, T_{stg}	-55 to 150		$^\circ\text{C}$	

THERMAL RESISTANCE RATINGS					
Parameter	Symbol	Typical	Maximum	Unit	
Maximum Junction-to-Ambient ^a	R_{thJA}	$t \leq 10$ sec	20	25	$^\circ\text{C/W}$
		Steady State	54	68	
Maximum Junction-to-Case (Drain)	R_{thJC}	1.7	2.2		

Notes

a. Surface Mounted on 1" x 1" FR4 Board.

SPECIFICATIONS (T_J = 25 °C UNLESS OTHERWISE NOTED)

Parameter	Symbol	Test Condition	Min	Typ	Max	Unit
Static						
Gate Threshold Voltage	V _{GS(th)}	V _{DS} = V _{GS} , I _D = -1 mA	-0.4		-0.9	V
Gate-Body Leakage	I _{GSS}	V _{DS} = 0 V, V _{GS} = ±8 V			±100	nA
Zero Gate Voltage Drain Current	I _{DSS}	V _{DS} = -9.6 V, V _{GS} = 0 V			-1	μA
		V _{DS} = -9.6 V, V _{GS} = 0 V, T _J = 70 °C			-10	
On-State Drain Current ^a	I _{D(on)}	V _{DS} ≤ -5 V, V _{GS} = -4.5 V	-40			A
Drain-Source On-State Resistance ^a	r _{DS(on)}	V _{GS} = -4.5 V, I _D = -21 A		0.0054	0.0065	Ω
		V _{GS} = -2.5 V, I _D = -19 A		0.0065	0.008	
		V _{GS} = -1.8 V, I _D = -16 A		0.0088	0.011	
Forward Transconductance ^a	g _{fs}	V _{DS} = -15 V, I _D = -21 A		80		S
Diode Forward Voltage ^a	V _{SD}	I _S = -4.5 A, V _{GS} = 0 V		-0.65	-1.1	V
Dynamic^b						
Total Gate Charge	Q _g	V _{DS} = -6 V, V _{GS} = -5 V, I _D = -21 A		93	140	nC
Gate-Source Charge	Q _{gs}			10.5		
Gate-Drain Charge	Q _{gd}			22		
Gate-Resistance	R _G			2.7		Ω
Turn-On Delay Time	t _{d(on)}	V _{DD} = -6 V, R _L = 6 Ω I _D ≅ -1 A, V _{GEN} = -4.5 V, R _G = 6 Ω		100	150	ns
Rise Time	t _r			200	300	
Turn-Off Delay Time	t _{d(off)}			350	530	
Fall Time	t _f			230	350	
Source-Drain Reverse Recovery Time	t _{rr}		I _F = -2.9 A, di/dt = 100 A/μs		110	

Notes

- a. Pulse test; pulse width ≤ 300 μs, duty cycle ≤ 2%.
- b. Guaranteed by design, not subject to production testing.

TYPICAL CHARACTERISTICS (25 °C UNLESS NOTED)

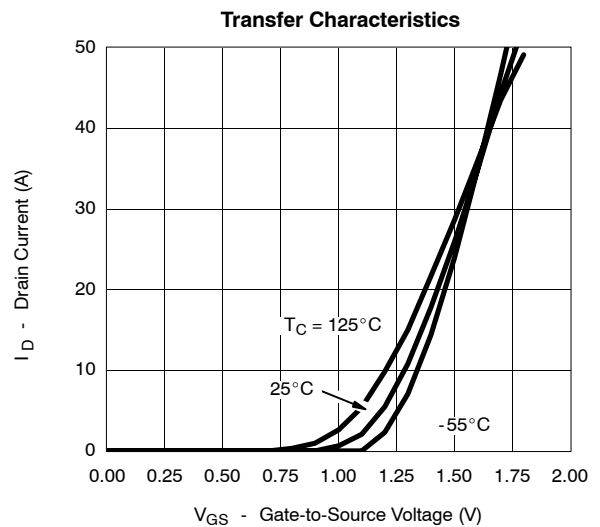
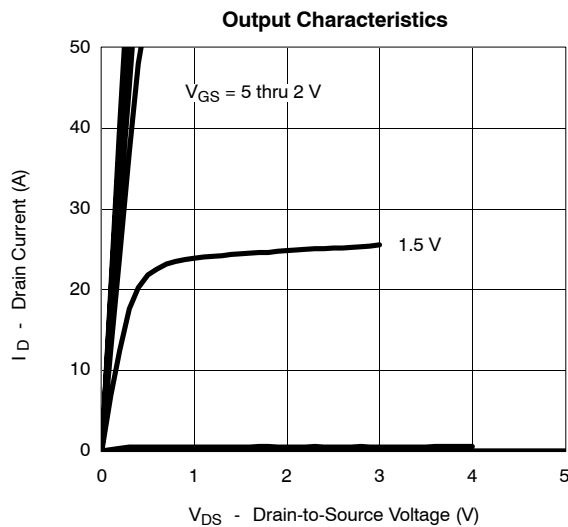



TYPICAL CHARACTERISTICS (25 °C UNLESS NOTED)

On-Resistance vs. Drain Current

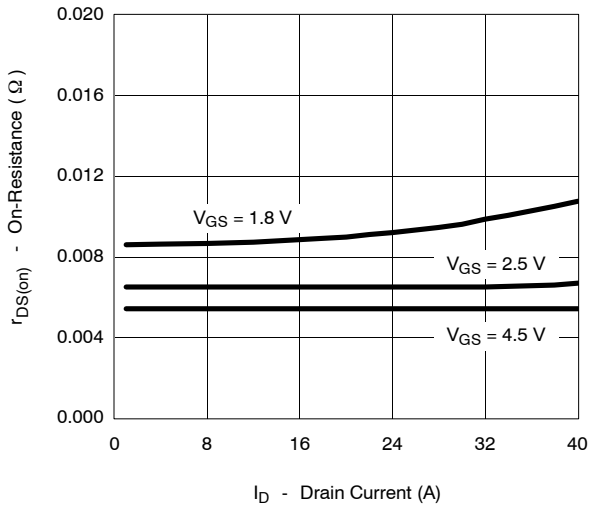

Capacitance

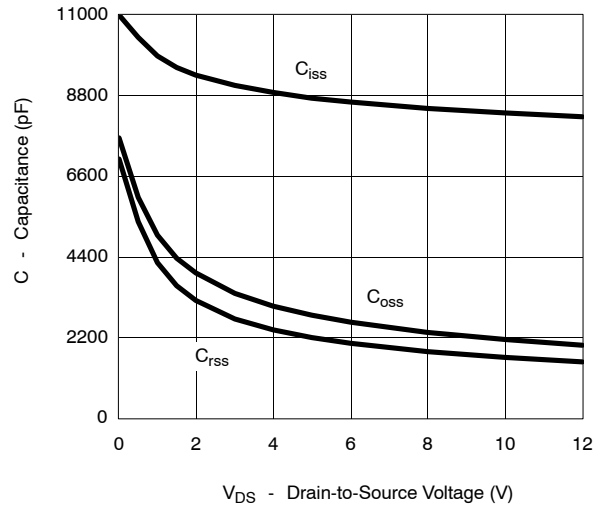

Gate Charge

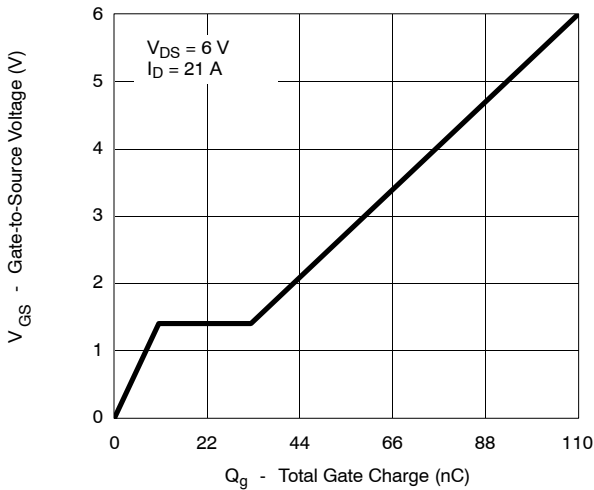

On-Resistance vs. Junction Temperature

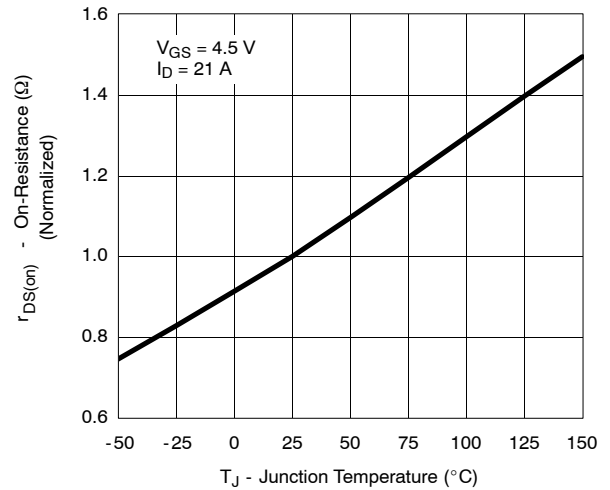

Source-Drain Diode Forward Voltage

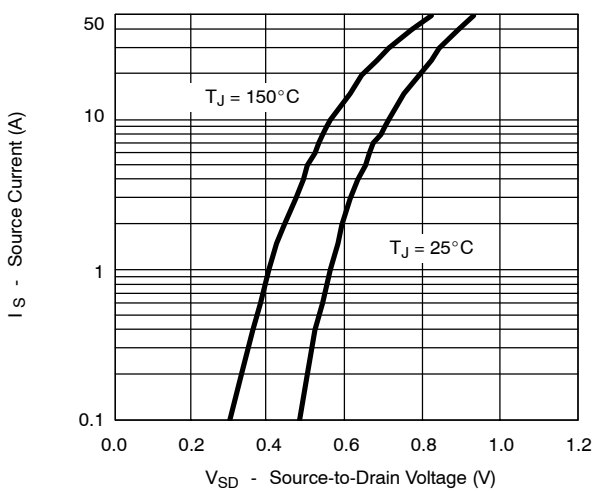

On-Resistance vs. Gate-to-Source Voltage

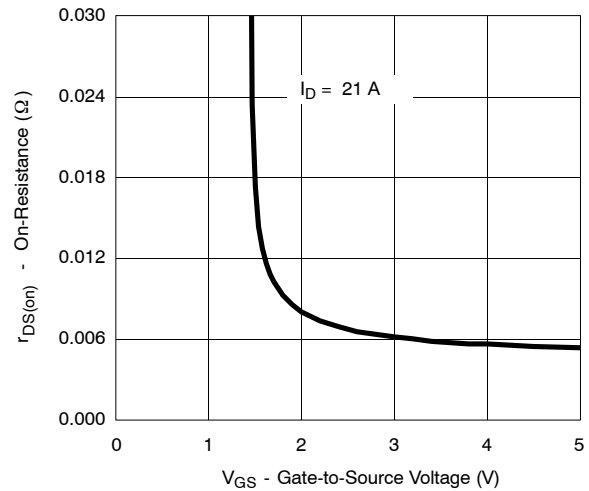

TYPICAL CHARACTERISTICS (25 °C UNLESS NOTED)

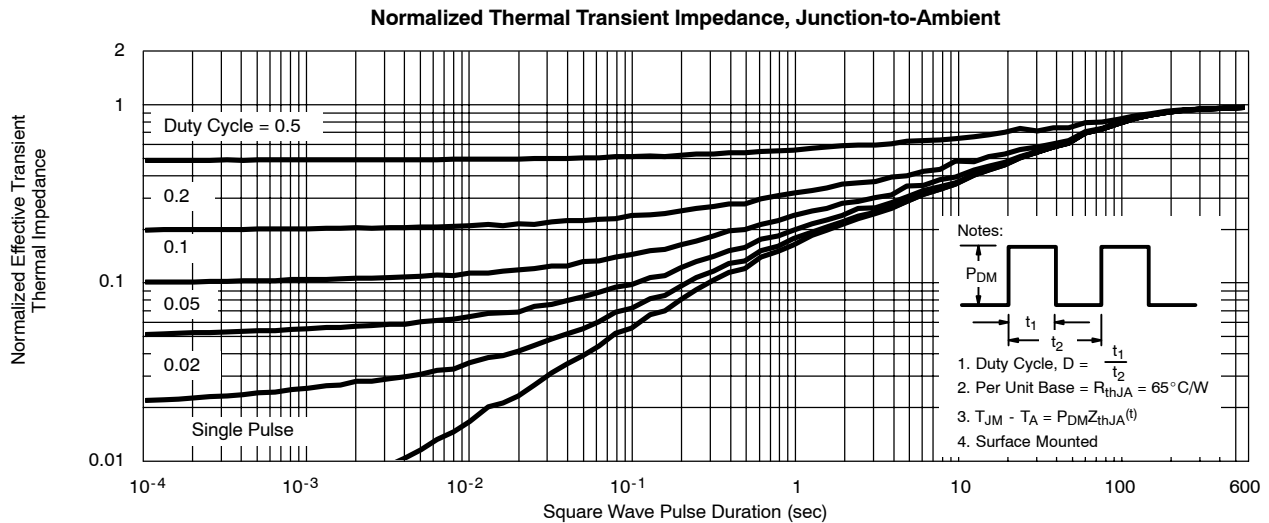
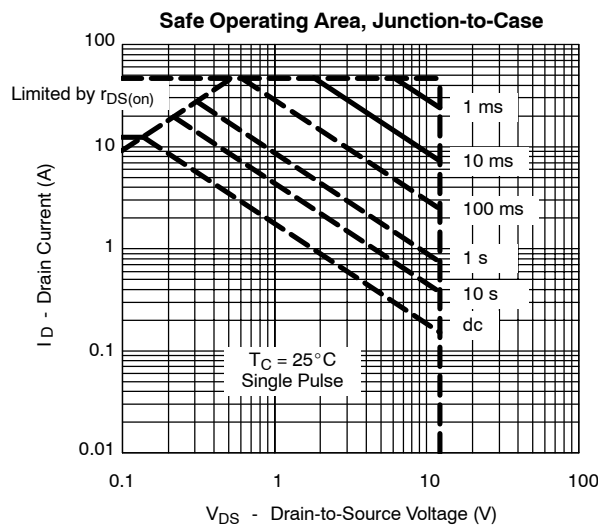
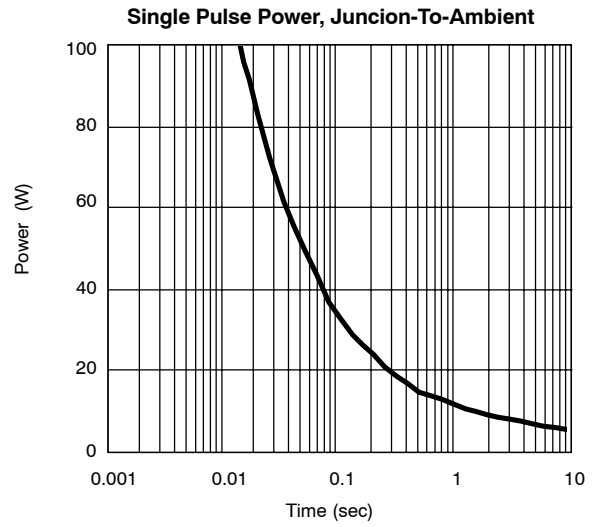
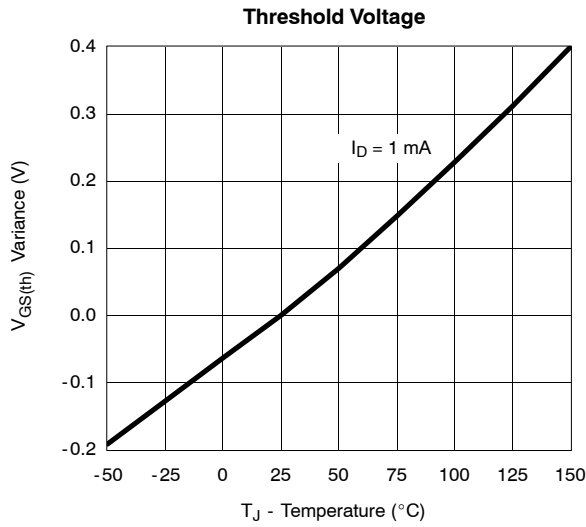



TYPICAL CHARACTERISTICS (25 °C UNLESS NOTED)

