

P-Channel 30-V (D-S) MOSFET

PRODUCT SUMMARY		
V_{DS} (V)	$r_{DS(on)}$ (Ω)	I_D (A)
-30	0.019 @ $V_{GS} = -4.5$ V	-11
	0.031 @ $V_{GS} = -2.5$ V	-8.5

FEATURES

- TrenchFET® Power MOSFET
- New Low Thermal Resistance PowerPAK™ Package with Low 1.07-mm Profile
- V_{DS} Optimized for Load Switch

APPLICATIONS

- Load Switch

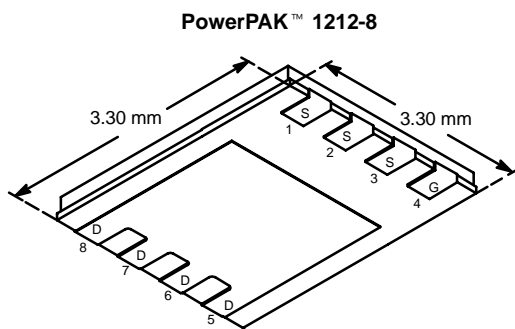

Bottom View

Ordering Information: Si7409DN-T1

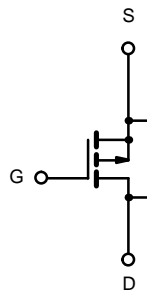

P-Channel MOSFET

ABSOLUTE MAXIMUM RATINGS ($T_A = 25^\circ\text{C}$ UNLESS OTHERWISE NOTED)					
Parameter	Symbol	10 secs	Steady State	Unit	
Drain-Source Voltage	V_{DS}	-30		V	
Gate-Source Voltage	V_{GS}	± 12			
Continuous Drain Current ($T_J = 150^\circ\text{C}$) ^a	I_D	$T_A = 25^\circ\text{C}$	-11	-7	A
		$T_A = 85^\circ\text{C}$	-7.9	-5	
Pulsed Drain Current	I_{DM}	-30			
continuous Source Current (Diode Conduction) ^a	I_S	-3.2	-1.3		
Maximum Power Dissipation ^a	P_D	$T_A = 25^\circ\text{C}$	3.8	1.5	W
		$T_A = 85^\circ\text{C}$	2.0	0.8	
Operating Junction and Storage Temperature Range	T_J, T_{stg}	-55 to 150		$^\circ\text{C}$	

THERMAL RESISTANCE RATINGS					
Parameter	Symbol	Typical	Maximum	Unit	
Maximum Junction-to-Ambient ^a	R_{thJA}	$t \leq 10$ sec	26	33	$^\circ\text{C/W}$
		Steady State	65	81	
Maximum Junction-to-Case	R_{thJC}	1.9	2.4		

Notes

a. Surface Mounted on 1" x 1" FR4 Board.

SPECIFICATIONS (T_J = 25 °C UNLESS OTHERWISE NOTED)

Parameter	Symbol	Test Condition	Min	Typ	Max	Unit
Static						
Gate Threshold Voltage	V _{GS(th)}	V _{DS} = V _{GS} , I _D = -250 μA	-0.6		-1.5	V
Gate-Body Leakage	I _{GSS}	V _{DS} = 0 V, V _{GS} = ±12 V			±100	nA
Zero Gate Voltage Drain Current	I _{DSS}	V _{DS} = -24 V, V _{GS} = 0 V			-1	μA
		V _{DS} = -24 V, V _{GS} = 0 V, T _J = 85 °C			-5	
On-State Drain Current ^a	I _{D(on)}	V _{DS} ≤ -5 V, V _{GS} = -4.5 V	-30			A
Drain-Source On-State Resistance ^a	r _{DS(on)}	V _{GS} = -4.5 V, I _D = -11 A		0.0015	0.019	Ω
		V _{GS} = -2.5 V, I _D = -8.5 A		0.025	0.031	
Forward Transconductance ^a	g _{fs}	V _{DS} = -15 V, I _D = -11 A		40		S
Diode Forward Voltage ^a	V _{SD}	I _S = -3.2 A, V _{GS} = 0 V		-0.7	-1.2	V
Dynamic^b						
Total Gate Charge	Q _g	V _{DS} = -15 V, V _{GS} = -4.5 V, I _D = -11 A		25	40	nC
Gate-Source Charge	Q _{gs}			5		
Gate-Drain Charge	Q _{gd}			9		
Turn-On Delay Time	t _{d(on)}	V _{DD} = -15 V, R _L = 15 Ω I _D ≅ -1 A, V _{GEN} = -4.5 V, R _G = 6 Ω		30	45	ns
Rise Time	t _r			50	75	
Turn-Off Delay Time	t _{d(off)}			115	175	
Fall Time	t _f			75	115	
Source-Drain Reverse Recovery Time	t _{rr}	I _F = -3.2 A, di/dt = 100 A/μs		60	90	

Notes

- a. Pulse test; pulse width ≤ 300 μs, duty cycle ≤ 2%.
b. Guaranteed by design, not subject to production testing.

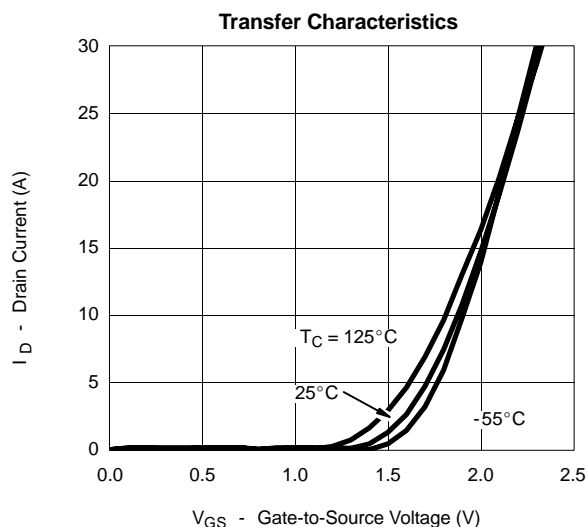
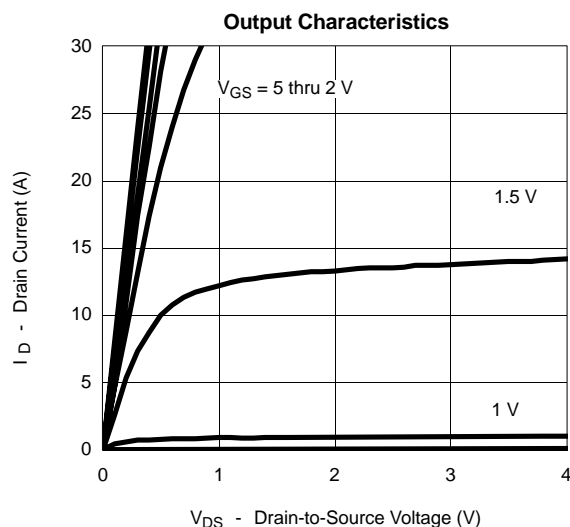
TYPICAL CHARACTERISTICS (25 °C UNLESS NOTED)



TYPICAL CHARACTERISTICS (25 °C UNLESS NOTED)

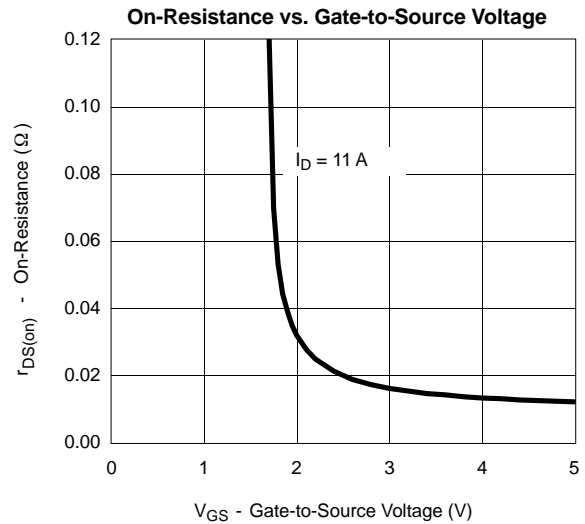
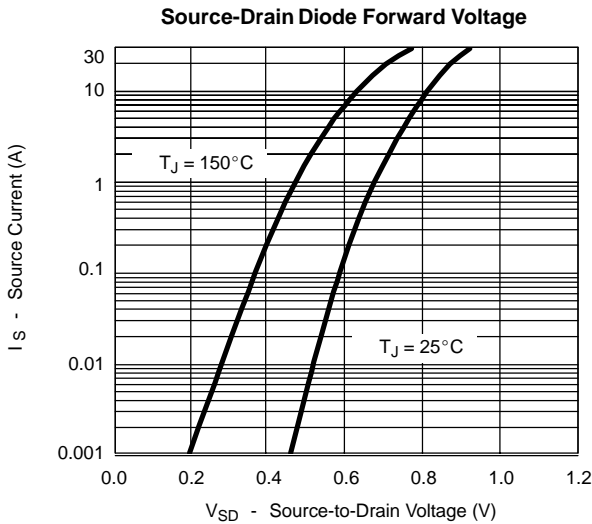
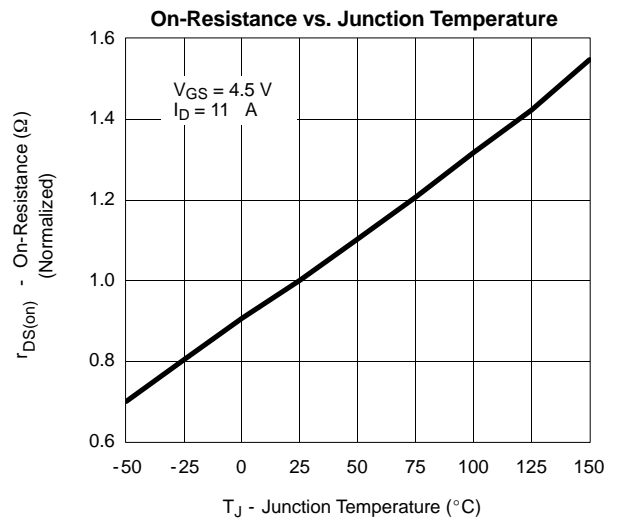
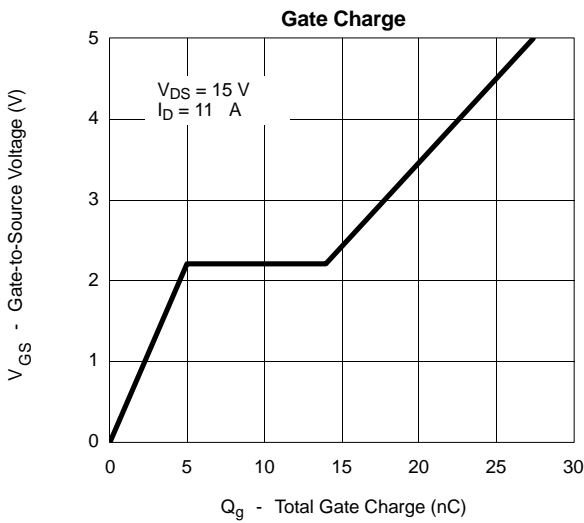
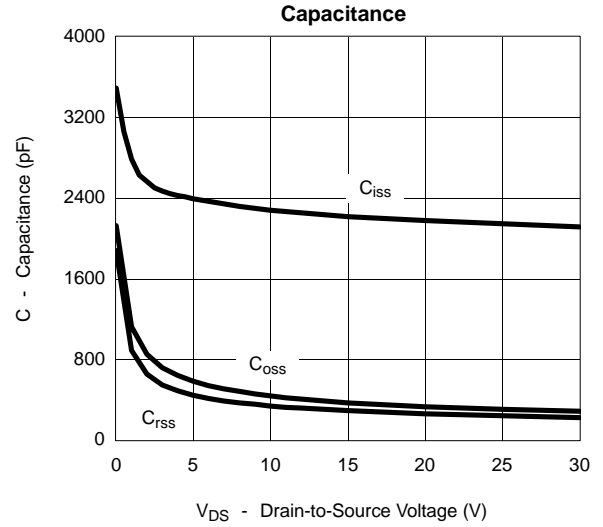
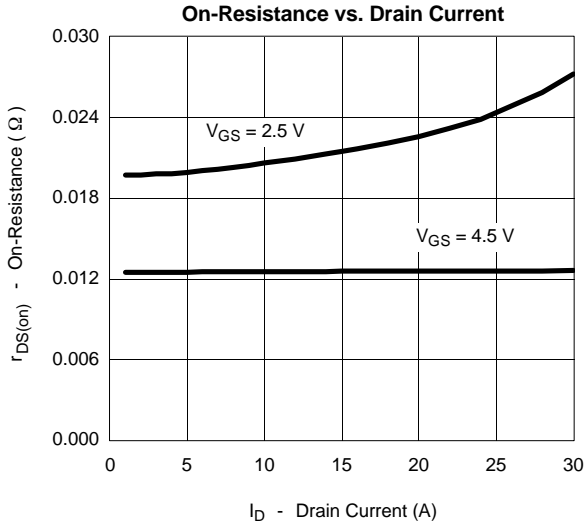

TYPICAL CHARACTERISTICS (25 °C UNLESS NOTED)

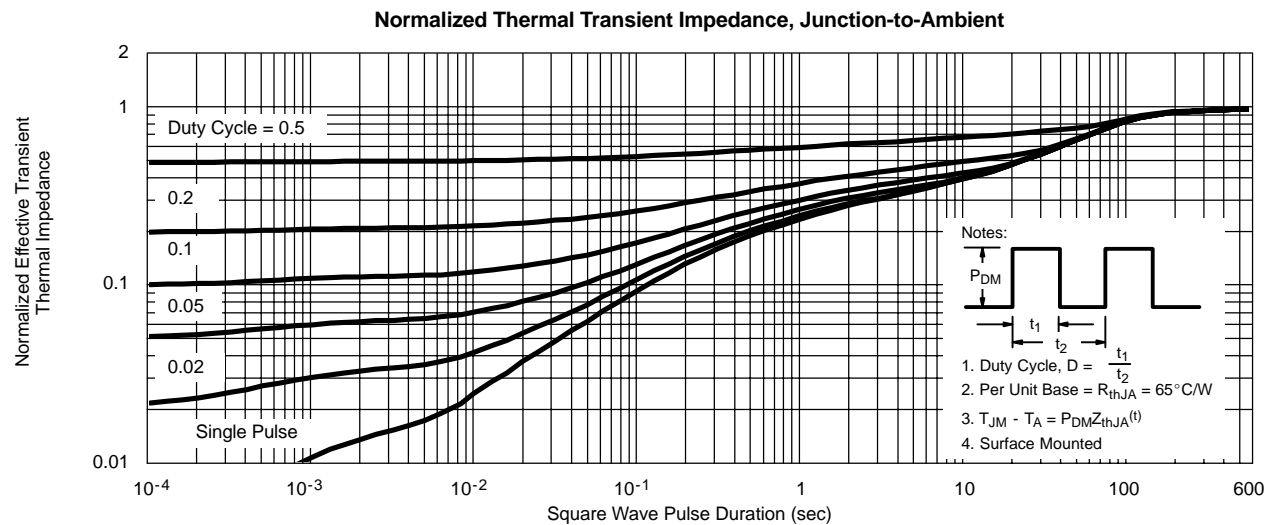
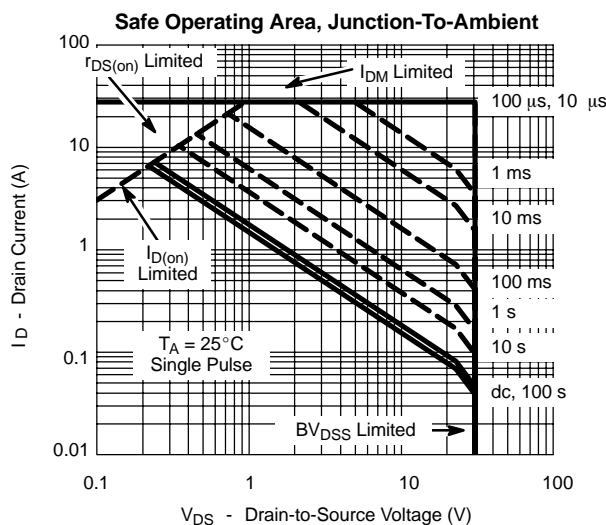
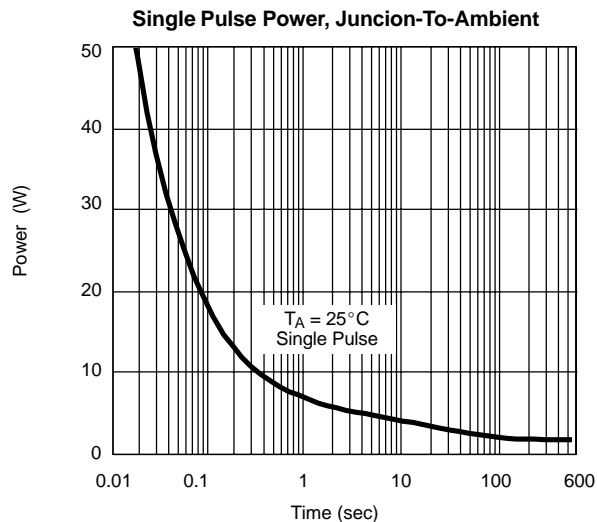
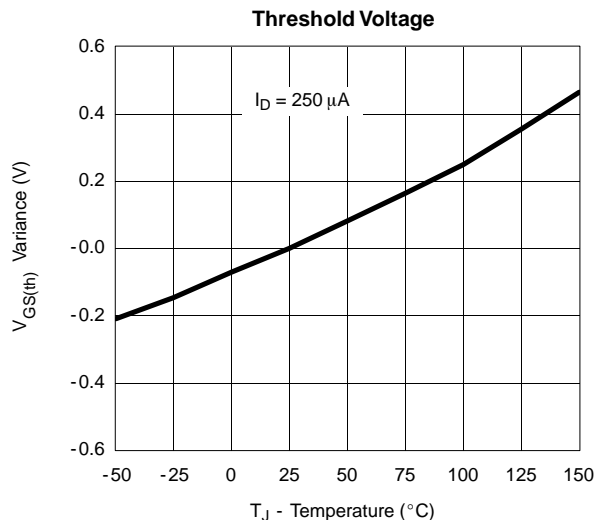



TYPICAL CHARACTERISTICS (25 °C UNLESS NOTED)

