



N-Channel 60-V (D-S) Fast Switching MOSFET

PRODUCT SUMMARY		
V_{DS} (V)	$r_{DS(on)}$ (Ω)	I_D (A)
60	0.0096 @ $V_{GS} = 10$ V	18
	0.012 @ $V_{GS} = 4.5$ V	16

FEATURES

- TrenchFET® Power MOSFET
- New Low Thermal Resistance PowerPAK® Package with Low 1.07-mm Profile

APPLICATIONS

- Automotive 12/24-V Battery
 - ABS
 - ECU
 - Motor Drives

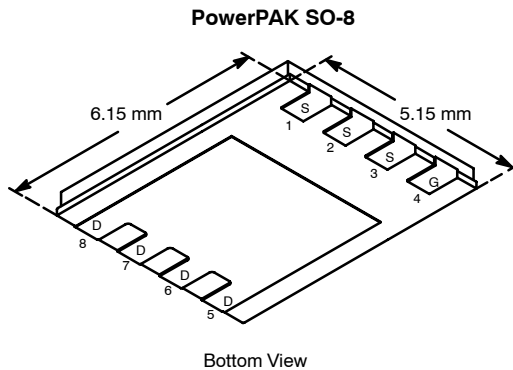

Ordering Information: Si7460DP-T1

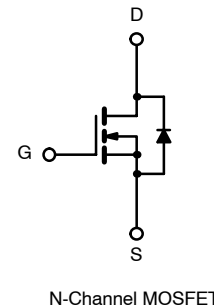

ABSOLUTE MAXIMUM RATINGS ($T_A = 25^\circ\text{C}$ UNLESS OTHERWISE NOTED)				
Parameter	Symbol	10 secs	Steady State	Unit
Drain-Source Voltage	V_{DS}	60		V
Gate-Source Voltage	V_{GS}	± 20		
Continuous Drain Current ($T_J = 150^\circ\text{C}$) ^a	I_D	$T_A = 25^\circ\text{C}$	18	11
		$T_A = 70^\circ\text{C}$	14	8
Pulsed Drain Current	I_{DM}	40		A
Continuous Source Current (Diode Conduction) ^a	I_S	4.3	1.6	
Avalanche Current	I_{AS}	50		
Avalanche Energy	E_{AS}	125		mJ
Maximum Power Dissipation ^a	P_D	$T_A = 25^\circ\text{C}$	5.4	1.9
		$T_A = 70^\circ\text{C}$	3.4	1.2
Operating Junction and Storage Temperature Range	T_J, T_{stg}	-55 to 150		$^\circ\text{C}$

THERMAL RESISTANCE RATINGS				
Parameter	Symbol	Typical	Maximum	Unit
Maximum Junction-to-Ambient ^a	R_{thJA}	$t \leq 10$ sec	18	23
		Steady State	52	65
Maximum Junction-to-Case (Drain)	R_{thJC}	1.0	1.3	$^\circ\text{C/W}$

Notes

a. Surface Mounted on 1" x 1" FR4 Board.

MOSFET SPECIFICATIONS (T_J = 25 °C UNLESS OTHERWISE NOTED)

Parameter	Symbol	Test Condition	Min	Typ	Max	Unit
Static						
Gate Threshold Voltage	V _{GS(th)}	V _{DS} = V _{GS} , I _D = 250 μA	1.0		3	V
Gate-Body Leakage	I _{GSS}	V _{DS} = 0 V, V _{GS} = ±20 V			±100	nA
Zero Gate Voltage Drain Current	I _{DSS}	V _{DS} = 48 V, V _{GS} = 0 V			1	μA
		V _{DS} = 48 V, V _{GS} = 0 V, T _J = 55 °C			5	
On-State Drain Current ^{NO TAG}	I _{D(on)}	V _{DS} ≥ 5 V, V _{GS} = 10 V	40			A
Drain-Source On-State Resistance ^{NO TAG}	r _{DS(on)}	V _{GS} = 10 V, I _D = 18 A		0.008	0.0096	Ω
		V _{GS} = 4.5 V, I _D = 16 A		0.010	0.012	
Forward Transconductance ^{NO TAG}	g _{fs}	V _{DS} = 15 V, I _D = 18 A		60		S
Diode Forward Voltage ^{NO TAG}	V _{SD}	I _S = 4.3 A, V _{GS} = 0 V		0.72	1.2	V
Dynamic^{NO TAG}						
Total Gate Charge	Q _g	V _{DS} = 30 V, V _{GS} = 10 V, I _D = 18 A		65	100	nC
Gate-Source Charge	Q _{gs}			10.5		
Gate-Drain Charge	Q _{gd}			16		
Turn-On Delay Time	t _{d(on)}	V _{DD} = 30 V, R _L = 30 Ω I _D ≅ 1 A, V _{GEN} = 10 V, R _G = 6 Ω		20	30	ns
Rise Time	t _r			16	25	
Turn-Off Delay Time	t _{d(off)}			75	120	
Fall Time	t _f			30	45	
Source-Drain Reverse Recovery Time	t _{rr}	I _F = 4.3 A, di/dt = 100 A/μs		41	65	

Notes

- Pulse test; pulse width ≤ 300 μs, duty cycle ≤ 2%.
- Guaranteed by design, not subject to production testing.

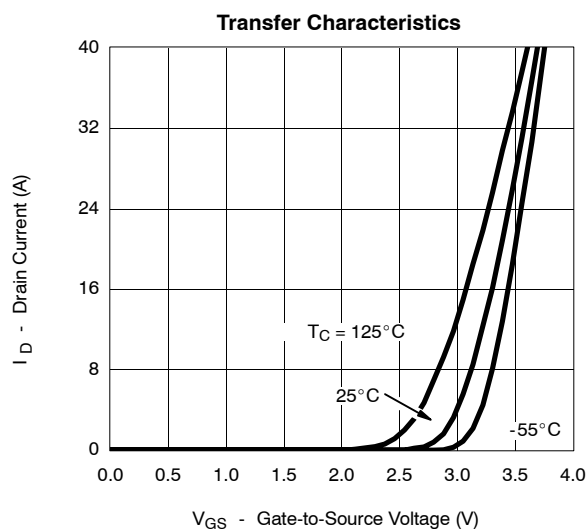
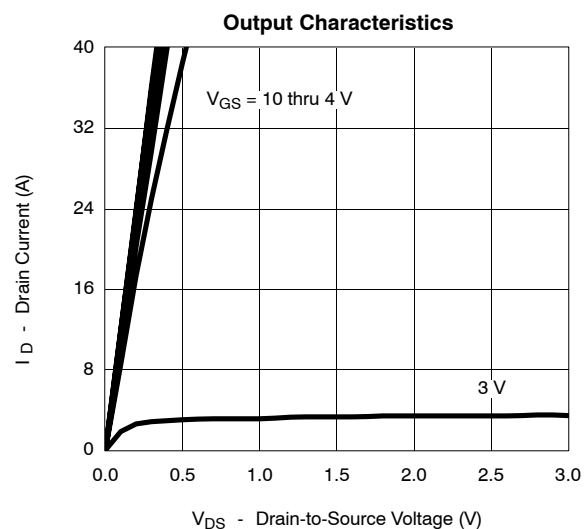
TYPICAL CHARACTERISTICS (25 °C UNLESS NOTED)



TYPICAL CHARACTERISTICS (25°C UNLESS NOTED)

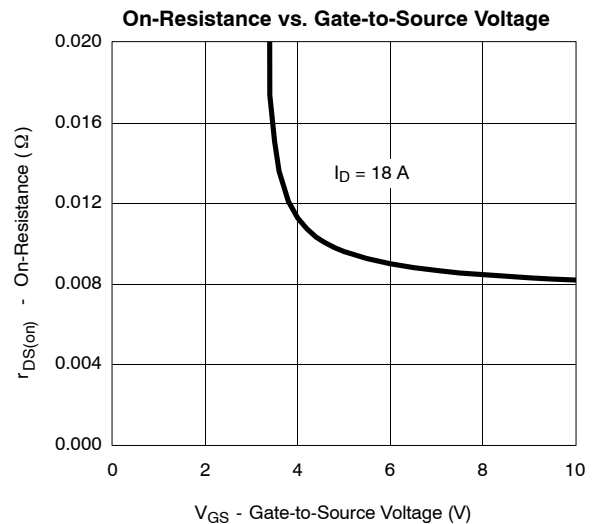
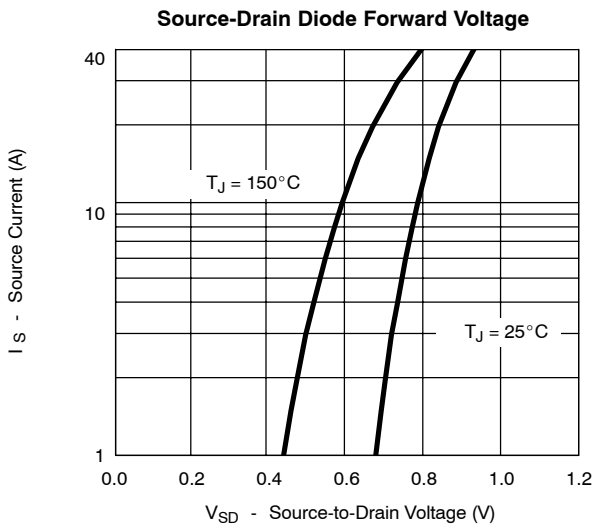
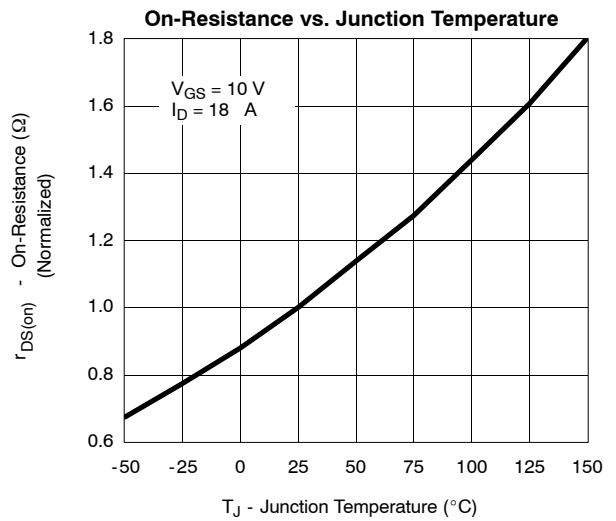
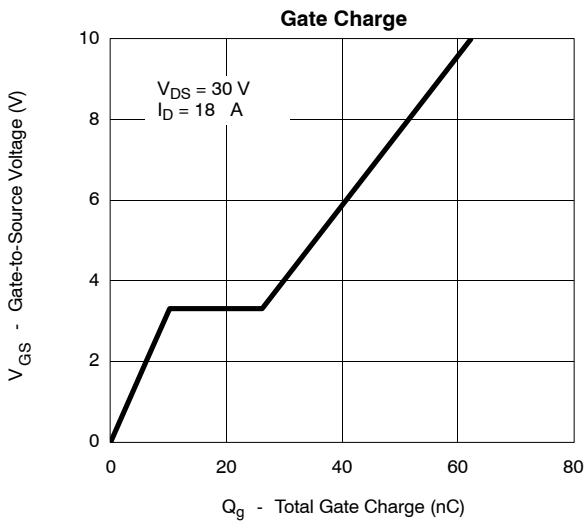
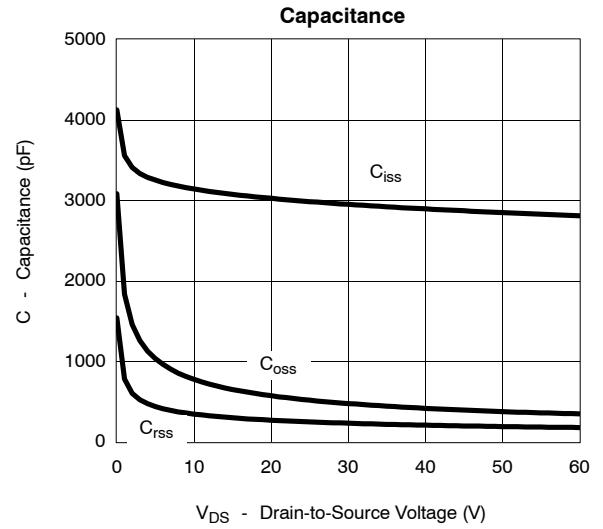
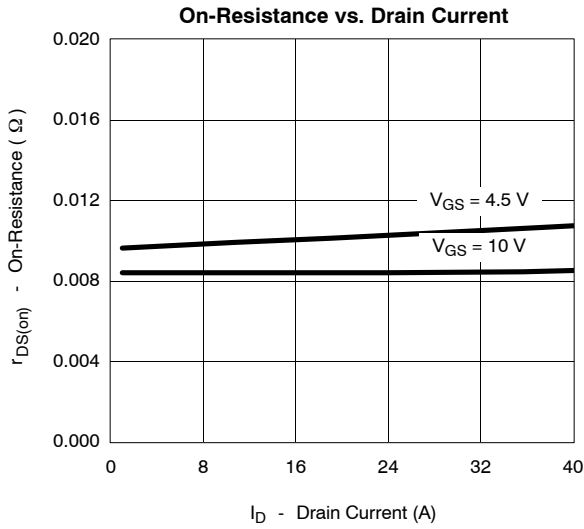



TYPICAL CHARACTERISTICS (25°C UNLESS NOTED)

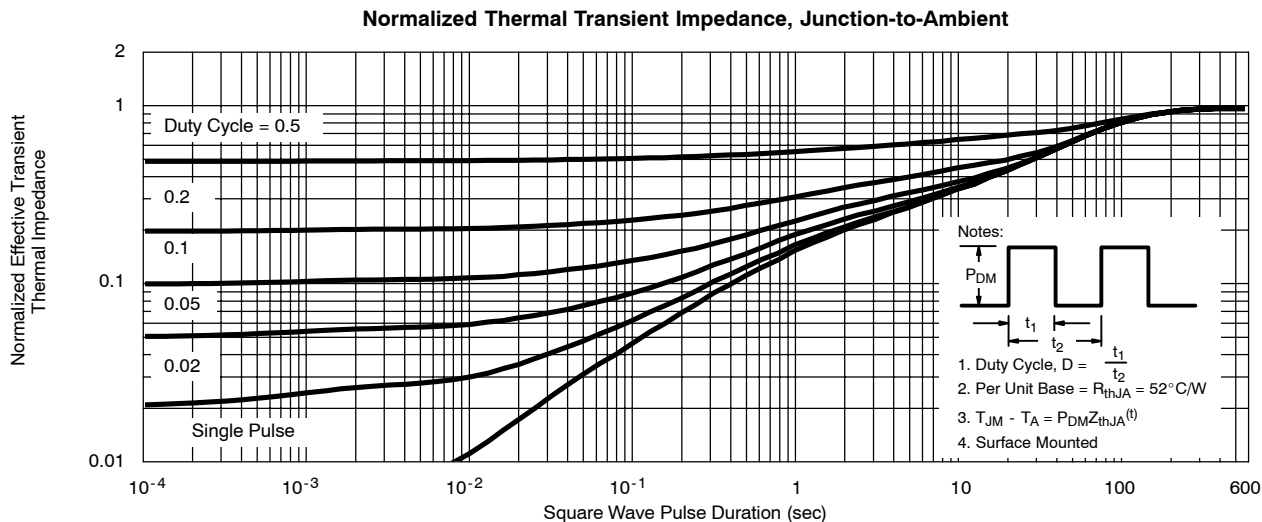
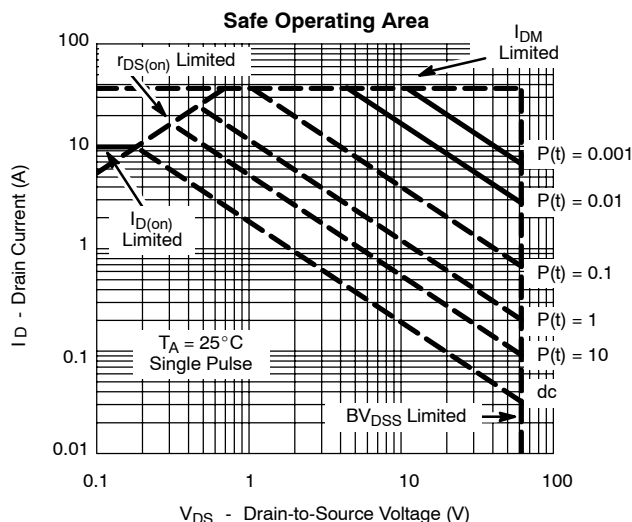
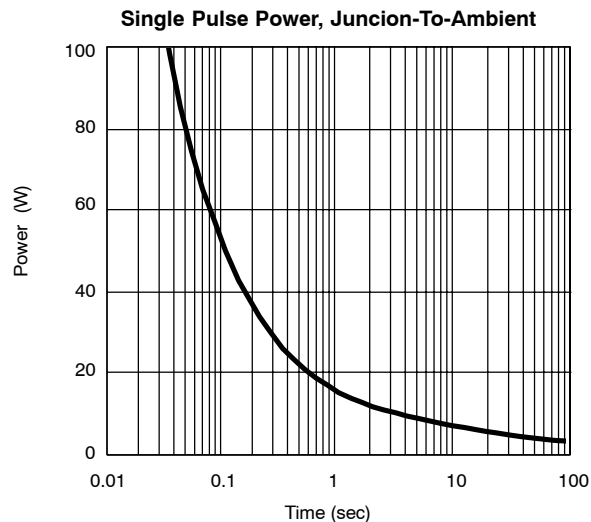
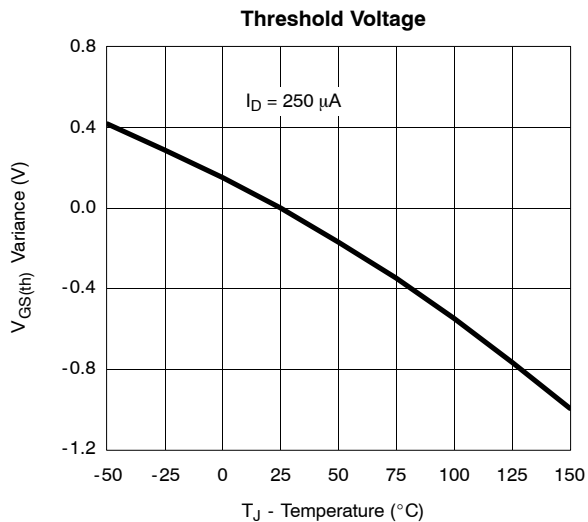



TYPICAL CHARACTERISTICS (25°C UNLESS NOTED)

