



Complete, Direct-Conversion Tuner for DVB-S2 Applications

General Description

The MAX2112 low-cost, direct-conversion tuner IC is designed for satellite set-top and VSAT applications. The IC is intended for 8PSK and Digital Video Broadcast (DVB-S2) applications.

The MAX2112 directly converts the satellite signals from the LNB to baseband using a broadband I/Q downconverter. The operating frequency range extends from 925MHz to 2175MHz.

The device includes an LNA and an RF variable-gain amplifier, I and Q downconverting mixers, and baseband lowpass filters with programmable cutoff frequency control and digitally controlled baseband variable-gain amplifiers. Together, the RF and baseband variable-gain amplifiers provide more than 80dB of gain control range. The IC is compatible with virtually all DVB-S2 demodulators.

The MAX2112 includes fully monolithic VCOs, as well as a complete fractional-N frequency synthesizer. Additionally, an on-chip crystal oscillator is provided along with a buffered output for driving additional tuners and demodulators. Synthesizer programming and device configuration are accomplished with a 2-wire serial interface. The IC features a VCO autoselect (VAS) function that automatically selects the proper VCO. For multituner applications, the device can be configured to have one of two 2-wire interface addresses. A low-power standby mode is available whereupon the signal path is shut down while leaving the reference oscillator, digital interface, and buffer circuits active, providing a method to reduce power in single and multituner applications.

The MAX2112 is the most advanced DBS tuner available today. The low noise figure eliminates the need for an external LNA. A small number of passive components are needed to form a complete DVB-S2 RF front-end solution. The tuner is available in a very small 28-pin thin QFN package.

Applications

DirectTV and Dish Network DBS
DVB-S2
VSATs

Features

- ◆ 925MHz to 2175MHz Frequency Range
- ◆ Monolithic VCO
Low Phase Noise: -97dBc/Hz at 10kHz
No Calibration Required
- ◆ High Dynamic Range: -75dBm to 0dBm
- ◆ Integrated Variable BW LP Filters: 4MHz to 40MHz
- ◆ Single +3.3V \pm 5% Supply
- ◆ Low-Power Standby Mode
- ◆ Multiple 2-Wire Addresses for Multituner Applications
- ◆ Differential I/Q Interface
- ◆ I²C 2-Wire Serial Interface
- ◆ Very Small 28-Pin TQFN Package

Ordering Information

| PART | TEMP RANGE | PIN-PACKAGE | PKG CODE |
|-------------|----------------|-----------------|----------|
| MAX2112CTI+ | 0°C to +70°C | 28 Thin QFN-EP* | T2855+3 |
| MAX2112ETI+ | -40°C to +85°C | 28 Thin QFN-EP* | T2855+3 |

*EP = Exposed paddle.

+Denotes a lead-free package.

Pin Configuration/ Functional Diagram

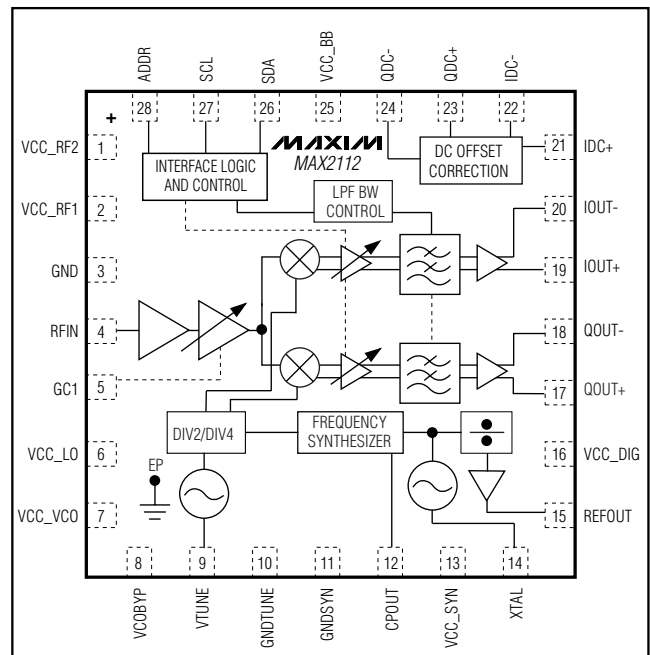

Complete, Direct-Conversion Tuner for DVB-S2 Applications

ABSOLUTE MAXIMUM RATINGS

VCC to GND-0.3V to +3.9V
 All Other Pins to GND.....-0.3V to (VCC + 0.3V)
 RF Input Power: RFIN+10dBm
 VCOBYP, CPOUT, XTAL, REFOUT, IOUT_, QOUT_, IDC_,
 QDC_ to GND Short-Circuit Protection.....10s
 Continuous Power Dissipation (TA = +70°C)
 28-Pin Thin QFN (derated 34.5mW/°C above +70°C) ...2.75W

Operating Temperature Range (MAX2112CTI+)0°C to +70°C
 Operating Temperature Range (MAX2112ETI+) ...-40°C to +85°C
 Junction Temperature+150°C
 Storage Temperature Range-65°C to +160°C
 Soldering Temperature (10s)+260°C

Stresses beyond those listed under "Absolute Maximum Ratings" may cause permanent damage to the device. These are stress ratings only, and functional operation of the device at these or any other conditions beyond those indicated in the operational sections of the specifications is not implied. Exposure to absolute maximum rating conditions for extended periods may affect device reliability.

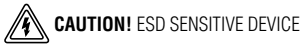

DC ELECTRICAL CHARACTERISTICS

(MAX2112 Evaluation Kit: VCC = +3.13V to +3.47V, TA = 0°C to +70°C (MAX2112CTI+), TA = -40°C to +85°C (MAX2112ETI+), VGC1 = +0.5V (max gain), default register settings except ICP = 1 and BBG[3:0] = 1011. No input signals at RF, baseband I/Os are open circuited. Typical values measured at VCC = +3.3V, TA = +25°C.) (Note 1)

| PARAMETER | CONDITIONS | MIN | TYP | MAX | UNITS |
|---|-----------------------------|-----------|------|-----------|-------|
| SUPPLY | | | | | |
| Supply Voltage | | 3.13 | 3.3 | 3.47 | V |
| Supply Current | Receive mode, bit STBY = 0 | | 100 | 160 | mA |
| | Standby mode, bit STBY = 1 | | 3 | | |
| ADDRESS SELECT INPUT (ADDR) | | | | | |
| Digital Input Voltage High, VIH | | 2.4 | | | V |
| Digital Input Voltage Low, VIL | | | | 0.5 | V |
| Digital Input Current High, IiH | | | | 50 | μA |
| Digital Input Current Low, IiL | | -50 | | | μA |
| ANALOG GAIN-CONTROL INPUTS (GC) | | | | | |
| Input Voltage Range | Maximum gain = 0.5V | 0.5 | | 2.7 | V |
| Input Bias Current | | -50 | | +50 | μA |
| VCO TUNING VOLTAGE INPUT (VTUNE) | | | | | |
| Input Voltage Range | | 0.4 | | 2.3 | V |
| 2-WIRE SERIAL INPUTS (SCL, SDA) | | | | | |
| Clock Frequency | | | | 400 | kHz |
| Input Logic-Level High | | 0.7 x VCC | | | V |
| Input Logic-Level Low | | | | 0.3 x VCC | V |
| Input Leakage Current | Digital inputs = GND or VCC | | ±0.1 | ±1 | μA |
| 2-WIRE SERIAL OUTPUT (SDA) | | | | | |
| Output Logic-Level Low | ISINK = 1mA | | | 0.4 | V |

Complete, Direct-Conversion Tuner for DVB-S2 Applications

MAX2112

AC ELECTRICAL CHARACTERISTICS

(MAX2112 Evaluation Kit: $V_{CC} = +3.13V$ to $+3.47V$, $T_A = 0^{\circ}C$ to $+70^{\circ}C$ (MAX2112CTI+), $T_A = -40^{\circ}C$ to $+85^{\circ}C$ (MAX2112ETI+), default register settings except $ICP = 1$ and $BBG[3:0]=1011$. Typical values measured at $V_{CC} = +3.3V$, $T_A = +25^{\circ}C$.) (Note 1)

| PARAMETER | CONDITIONS | MIN | TYP | MAX | UNITS |
|--|---|-----|------|------|------------------|
| MAIN SIGNAL PATH PERFORMANCE | | | | | |
| Input Frequency Range | (Note 2) | 925 | | 2175 | MHz |
| RF Gain-Control Range (GC1) | $0.5V < V_{GC1} < 2.7V$ | 65 | 73 | | dB |
| Baseband Gain-Control Range | Bits GC2 = 1111 to 0000 | 13 | 15 | | dB |
| In-Band Input IP3 | (Note 3) | | +2 | | dBm |
| Out-of-Band Input IP3 | (Note 4) | | +15 | | dBm |
| Input IP2 | (Note 5) | | +40 | | dBm |
| Adjacent Channel Protection | (Note 6) | | 25 | | dB |
| Noise Figure | V_{GC1} is set to 0.5V (maximum RF gain) and $BBG[3:0]$ is adjusted to give a 1V _{P-P} baseband output level for a -75dBm CW input tone at 1500MHz | | 8 | | dB |
| | Starting with the same $BBG[3:0]$ setting as above, V_{GC1} is adjusted to back off RF gain by 10dB (Note 7) | | 9 | 12 | |
| Minimum RF Input Return Loss | $925MHz < f_{RF} < 2175MHz$, in 75Ω system | | 12 | | dB |
| BASEBAND OUTPUT CHARACTERISTICS | | | | | |
| Nominal Output Voltage Swing | $R_{LOAD} = 2k\Omega//10pF$ | 0.5 | 1 | | V _{P-P} |
| I/Q Amplitude Imbalance | Measured at 500kHz; filter set to 22.27MHz | | | ±1 | dB |
| I/Q Quadrature Phase Imbalance | Measured at 500kHz; filter set to 22.27MHz | | | 3.5 | Degrees |
| Single-Ended I/Q Output Impedance | Real Z_O , from 1MHz to 40MHz | | 30 | | Ω |
| Output 1dB Compression Voltage | Differential | | 3.3 | | V _{P-P} |
| Baseband Highpass -3dB Frequency Corner | 47nF capacitors at IDC_, QDC_ | | 400 | | Hz |
| BASEBAND LOWPASS FILTERS | | | | | |
| Filter Bandwidth Range | | 4 | | 40 | MHz |
| Rejection Ratio | At $2 \times f_{-3dB}$ | | 39 | | dB |
| Group Delay | Up to 1dB bandwidth | | 37 | | ns |
| Ratio of In-Filter-Band to Out-of-Filter-Band Noise | $f_{INBAND} = 100Hz$ to $22.5MHz$, $f_{OUTBAND} = 87.5MHz$ to $112.5MHz$ | | 25 | | dB |
| FREQUENCY SYNTHESIZER | | | | | |
| RF-Divider Frequency Range | | 925 | | 2175 | MHz |
| RF-Divider Range (N) | | 19 | | 251 | |
| Reference-Divider Frequency Range | | 12 | | 30 | MHz |
| Reference-Divider Range (R) | | 1 | | 1 | |
| Phase-Detector Comparison Frequency | | 12 | | 30 | MHz |
| VOLTAGE-CONTROLLED OSCILLATOR AND LO GENERATION | | | | | |
| Guaranteed LO Frequency Range | | 925 | | 2175 | MHz |
| LO Phase Noise | $f_{OFFSET} = 10kHz$ | | -97 | | dBc/Hz |
| | $f_{OFFSET} = 100kHz$ | | -100 | | |
| | $f_{OFFSET} = 1MHz$ | | -122 | | |

Complete, Direct-Conversion Tuner for DVB-S2 Applications

AC ELECTRICAL CHARACTERISTICS (continued)

(MAX2112 Evaluation Kit: $V_{CC} = +3.13V$ to $+3.47V$, $T_A = 0^{\circ}C$ to $+70^{\circ}C$ (MAX2112CTI+), $T_A = -40^{\circ}C$ to $+85^{\circ}C$ (MAX2112ETI+), default register settings except $I_{CP} = 1$ and $BBG[3:0]=1011$. Typical values measured at $V_{CC} = +3.3V$, $T_A = +25^{\circ}C$.) (Note 1)

| PARAMETER | CONDITIONS | MIN | TYP | MAX | UNITS |
|--|----------------------------------|-----|-----|-----|------------------|
| XTAL/REFERENCE OSCILLATOR INPUT AND OUTPUT BUFFER | | | | | |
| XTAL Oscillator Frequency Range | Parallel-resonance-mode crystal | 12 | | 30 | MHz |
| Input Overdrive level | AC-coupled sine-wave input | 0.5 | 1 | 2.0 | V _{P-P} |
| XTAL Output-Buffer Divider Range | | 1 | | 8 | |
| XTAL Output Voltage Swing | 4MHz to 30MHz, $C_{LOAD} = 10pF$ | 1 | 1.5 | 2 | V _{P-P} |
| XTAL Output Duty Cycle | | | 50 | | % |

Note 1: MAX2112CTI+: Min/max values are production tested at $T_A = +70^{\circ}C$. Min/max limits at $T_A = 0^{\circ}C$ and $T_A = +25^{\circ}C$ are guaranteed by design and characterization.

MAX2112ETI+: Min/max values are production tested at $T_A = +85^{\circ}C$. Min/max limits at $T_A = -40^{\circ}C$ and $T_A = +25^{\circ}C$ are guaranteed by design and characterization.

Note 2: Input gain range specifications met over this band.

Note 3: In-band IIP3 test conditions: GC1 set to provide the nominal baseband output drive when mixing down a -23dBm tone at 2175MHz to 5MHz baseband ($f_{LO} = 2170MHz$). Baseband gain is set to its default value ($BBG[3:0] = 1011$). Two tones at -26dBm each are applied at 2174MHz and 2175MHz. The IM3 tone at 3MHz is measured at baseband, but is referred to the RF input.

Note 4: Out-of-band IIP3 test conditions: GC1 set to provide nominal baseband output drive when mixing down a -23dBm tone at 2175MHz to 5MHz baseband ($f_{LO} = 2170MHz$). Baseband gain is set to its default value ($BBG[3:0] = 1011$). Two tones at -20dBm each are applied at 2070MHz and 1975MHz. The IM3 tone at 5MHz is measured at baseband, but is referred to the RF input.

Note 5: Input IP2 test conditions: GC1 set to provide nominal baseband output drive when mixing down a -23dBm tone at 2175MHz to 5MHz baseband ($f_{LO} = 2170MHz$). Baseband gain is set to its default value ($BBG[3:0] = 1011$). Two tones at -20dBm each are applied at 925MHz and 1250MHz. The IM2 tone at 5MHz is measured at baseband, but is referred to the RF input.

Note 6: Adjacent channel protection test conditions: GC1 is set to provide the nominal baseband output drive with a 2110MHz 27.5Mbaud signal at -55dBm. GC2 set for mid-scale. The test signal shall be set for PR = 7/8 and SNR of -8.5dB. An adjacent channel at $\pm 40MHz$ is added at -25dBm. DVB-S BER performance of $2E-4$ shall be maintained for the desired signal. GC2 may be adjusted for best performance.

Note 7: Guaranteed by design and characterization at $T_A = +25^{\circ}C$.

Complete, Direct-Conversion Tuner for DVB-S2 Applications

MAX2112

Typical Operating Characteristics

(MAX2112 Evaluation Kit: $V_{CC} = +3.3V$, $T_A = +25^\circ C$, baseband output frequency = 5MHz; $V_{GC1} = +1.2V$, default register settings except ICP = 1 and BBG[3:0] = 1011.)

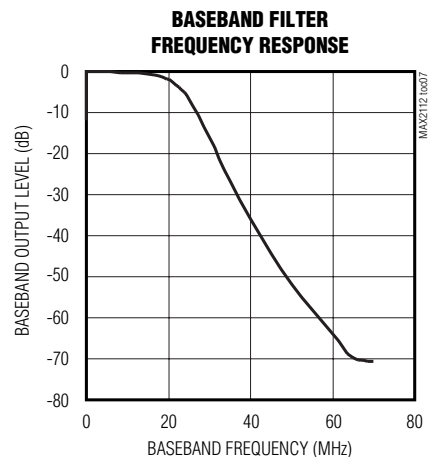
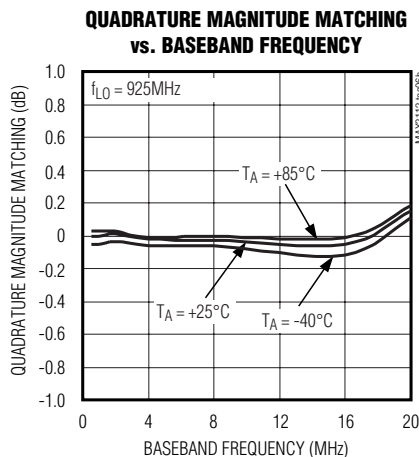
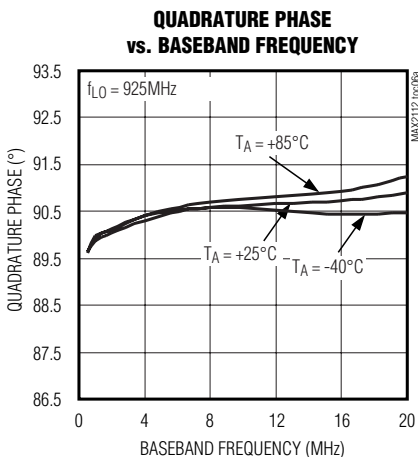
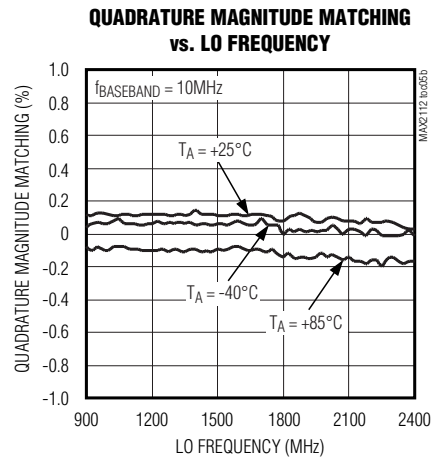
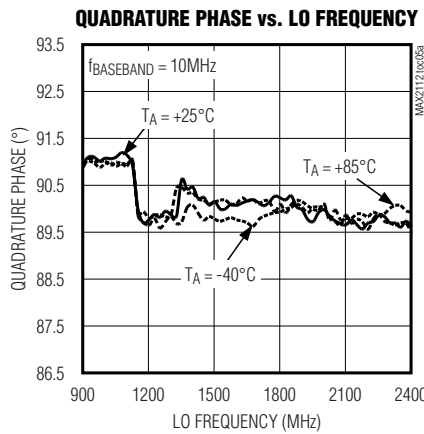
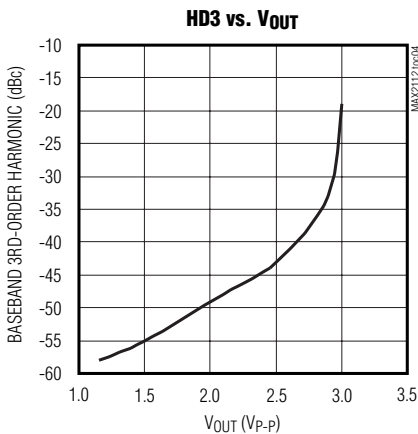
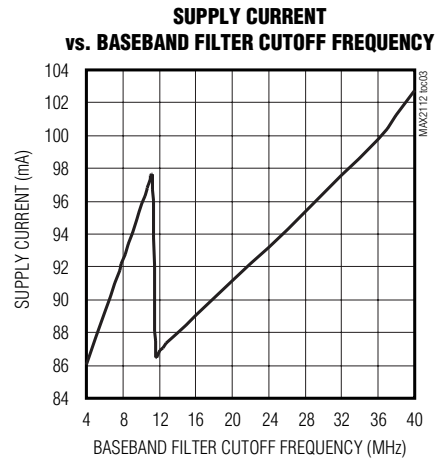
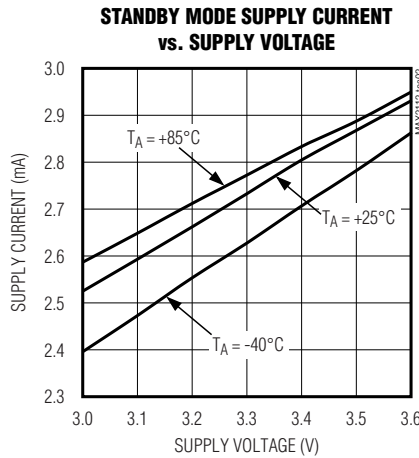
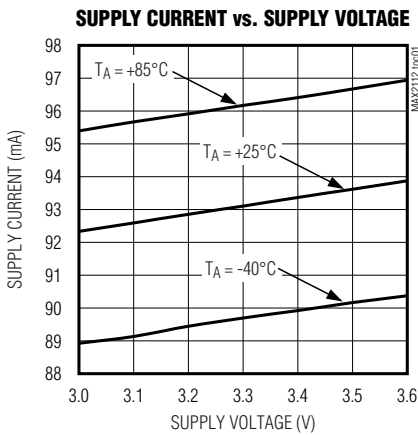

Complete, Direct-Conversion Tuner for DVB-S2 Applications

Typical Operating Characteristics (continued)

(MAX2112 Evaluation Kit: $V_{CC} = +3.3V$, $T_A = +25^\circ C$, baseband output frequency = 5MHz; $V_{GC1} = +1.2V$, default register settings except ICP = 1 and BBG[3:0] = 1011.)

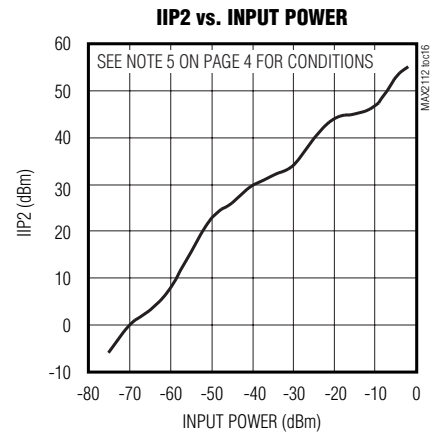
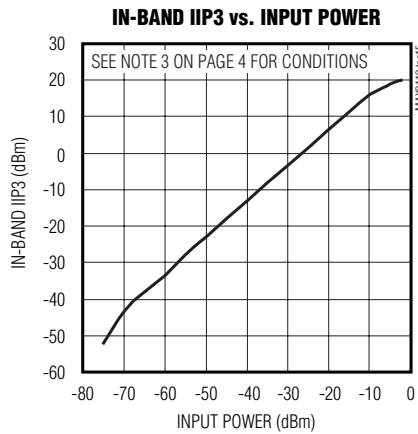
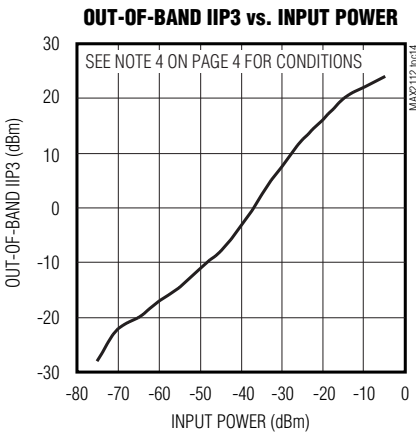
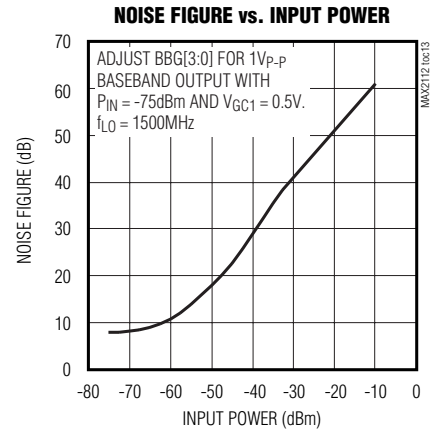
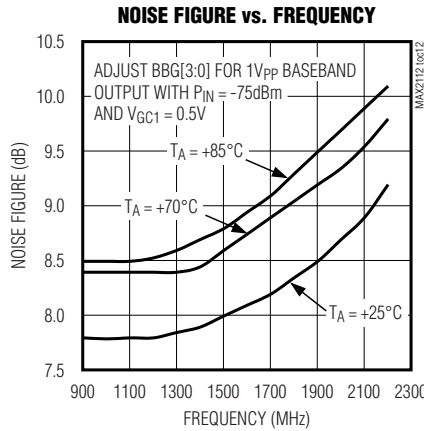
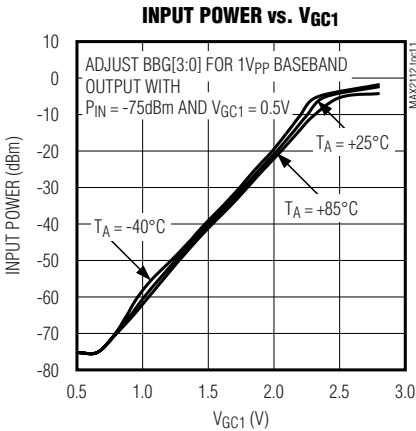
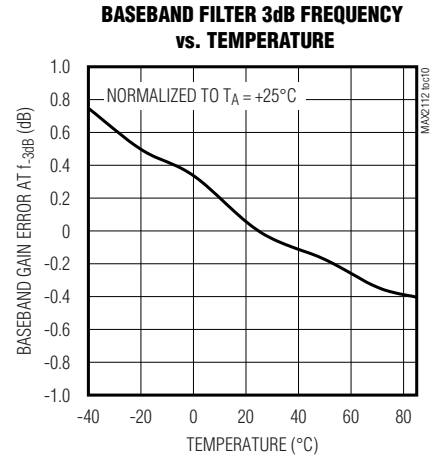
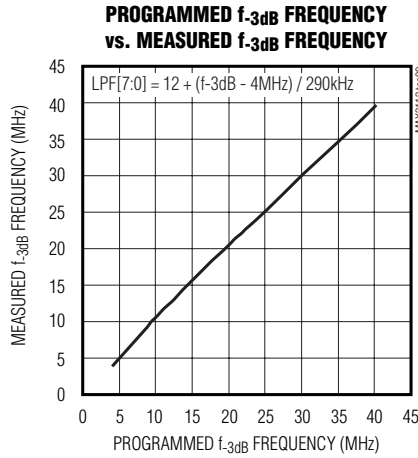
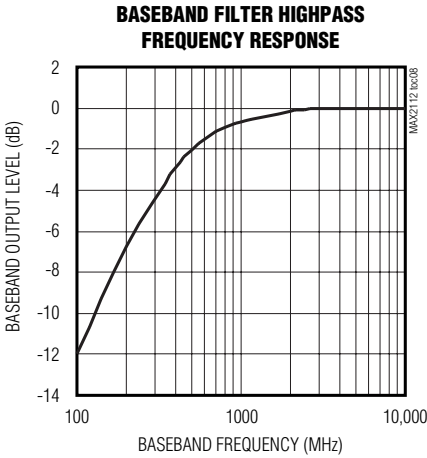

Complete, Direct-Conversion Tuner for DVB-S2 Applications

MAX2112

Typical Operating Characteristics (continued)

(MAX2112 Evaluation Kit: $V_{CC} = +3.3V$, $T_A = +25^\circ C$, baseband output frequency = 5MHz; $V_{GC1} = +1.2V$, default register settings except ICP = 1 and BBG[3:0] = 1011.)

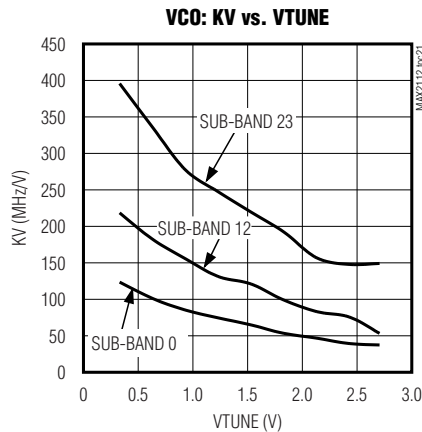
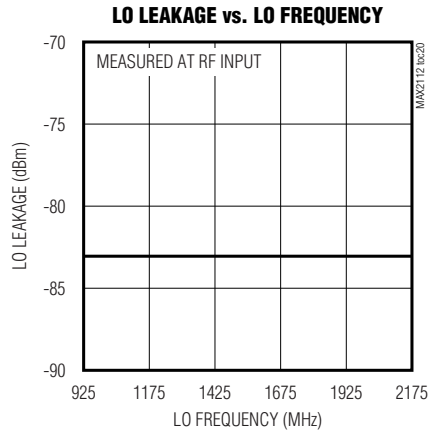
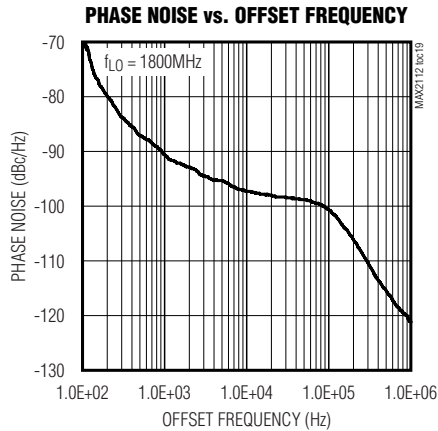
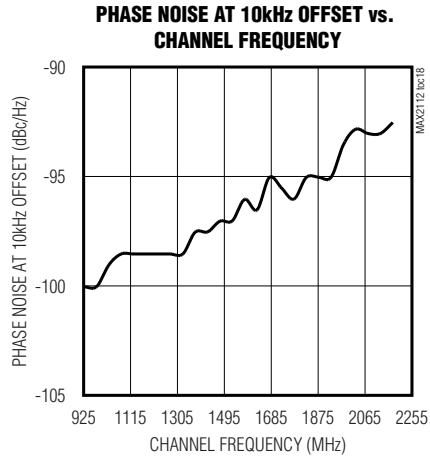
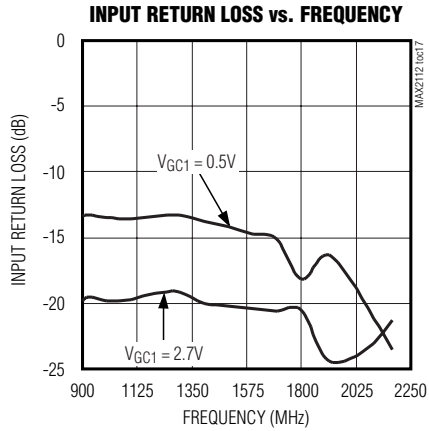

Complete, Direct-Conversion Tuner for DVB-S2 Applications

Pin Description

| PIN | NAME | DESCRIPTION |
|-----|---------|--|
| 1 | VCC_RF2 | DC Power Supply for LNA. Connect to a +3.3V low-noise supply. Bypass to GND with a 1nF capacitor connected as close as possible to the pin. Do not share capacitor ground vias with other ground connections. |
| 2 | VCC_RF1 | DC Power Supply for LNA. Connect to a +3.3V low-noise supply. Bypass to GND with a 1nF capacitor connected as close as possible to the pin. Do not share capacitor ground vias with other ground connections. |
| 3 | GND | Ground. Connect to board's ground plane for proper operation. |
| 4 | RFIN | Wideband 75Ω RF Input. Connect to an RF source through a DC-blocking capacitor. |
| 5 | GC1 | RF Gain-Control Input. High-impedance analog input with a 0.5V to 2.7V operating range. $V_{GC1} = 0.5V$ corresponds to the maximum gain setting. |
| 6 | VCC_LO | DC Power Supply for LO Generation Circuits. Connect to a +3.3V low-noise supply. Bypass to GND with a 1nF capacitor connected as close as possible to the pin. Do not share capacitor ground vias with other ground connections. |
| 7 | VCC_VCO | DC Power Supply for VCO Circuits. Connect to a +3.3V low-noise supply. Bypass to GND with a 1nF capacitor connected as close as possible to the pin. Do not share capacitor ground vias with other ground connections. |
| 8 | VCOBYP | Internal VCO Bias Bypass. Bypass to GND with a 100nF capacitor connected as close as possible to the pin. Do not share capacitor ground vias with other ground connections. |
| 9 | VTUNE | High-Impedance VCO Tune Input. Connect the PLL loop filter output directly to this pin with as short of a connection as possible. |
| 10 | GNDTUNE | Ground for VTUNE. Connect to the PCB ground plane. |
| 11 | GNDSYN | Ground for Synthesizer. Connect to the PCB ground plane. |
| 12 | CPOUT | Charge-Pump Output. Connect this output to the PLL loop filter input with the shortest connection possible. |
| 13 | VCC_SYN | DC Power Supply for Synthesizer Circuits. Connect to a +3.3V low-noise supply. Bypass to GND with a 1nF capacitor connected as close as possible to the pin. Do not share capacitor ground vias with other ground connections. |
| 14 | XTAL | Crystal-Oscillator Interface. Use with an external parallel-resonance-mode crystal through a series 1nF capacitor. See the <i>Typical Application Circuit</i> . |
| 15 | REFOUT | Crystal-Oscillator Buffer Output. A DC-blocking capacitor must be used when driving external circuitry. |
| 16 | VCC_DIG | DC Power Supply for Digital Logic Circuits. Connect to a +3.3V low-noise supply. Bypass to GND with a 1nF capacitor connected as close as possible to the pin. Do not share capacitor ground vias with other ground connections. |
| 17 | QOUT+ | Quadrature Baseband Differential Output. AC-couple with 47nF capacitors to the demodulator input. |
| 18 | QOUT- | |
| 19 | IOUT+ | In-Phase Baseband Differential Output. AC-couple with 47nF capacitors to the demodulator input. |
| 20 | IOUT- | |
| 21 | IDC+ | I-Channel Baseband DC Offset Correction. Connect a 47nF ceramic chip capacitor from IDC- to IDC+. |
| 22 | IDC- | |
| 23 | QDC+ | Q-Channel Baseband DC Offset Correction. Connect a 47nF ceramic chip capacitor from QDC- to QDC+. |
| 24 | QDC- | |
| 25 | VCC_BB | DC Power Supply for Baseband Circuits. Connect to a +3.3V low-noise supply. Bypass to GND with a 1nF capacitor connected as close as possible to the pin. Do not share capacitor ground vias with other ground connections. |

Complete, Direct-Conversion Tuner for DVB-S2 Applications

MAX2112

Pin Description (continued)

| PIN | NAME | DESCRIPTION |
|-----|------|--|
| 26 | SDA | 2-Wire Serial-Data Interface. Requires a 2.7kΩ pullup resistor to V _{CC} . |
| 27 | SCL | 2-Wire Serial-Clock Interface. Requires a 2.7kΩ pullup resistor to V _{CC} . |
| 28 | ADDR | Address. Must be connected to either ground (logic 0) or supply (logic 1). |
| — | EP | Exposed Paddle. Solder evenly to the board's ground plane for proper operation. |

Detailed Description

Register Description

The MAX2112 includes 12 user-programmable registers and 2 read-only registers. See Table 1 for register

configurations. The register configuration of Table 1 shows each bit name and the bit usage information for all registers. Note that all registers must be written after and no earlier than 100μs after the device is powered up.

Table 1. Register Configuration

| REG NUMBER | REGISTER NAME | READ/ WRITE | REG ADDRESS | MSB | | | | | | | | LSB | |
|------------|------------------------|-------------|-------------|------------|------------|------------|------------|-----------|-------------|-------------|-------------|------|------|
| | | | | DATA BYTE | | | | | | | | D[1] | D[0] |
| | | | | D[7] | D[6] | D[5] | D[4] | D[3] | D[2] | D[1] | D[0] | | |
| 1 | N-Divider MSB | Write | 0x00 | FRAC 1 | N[14] | N[13] | N[12] | N[11] | N[10] | N[9] | N[8] | | |
| 2 | N-Divider LSB | Write | 0x01 | N[7] | N[6] | N[5] | N[4] | N[3] | N[2] | N[1] | N[0] | | |
| 3 | Charge Pump | Write | 0x02 | CPMP[1] 0 | CPMP[0] 0 | CPLIN[1] 0 | CPLIN[0] 0 | F[19] | F[18] | F[17] | F[16] | | |
| 4 | F-Divider MSB | Write | 0x03 | F[15] | F[14] | F[13] | F[12] | F[11] | F[10] | F[9] | F[8] | | |
| 5 | F-Divider LSB | Write | 0x04 | F[7] | F[6] | F[5] | F[4] | F[3] | F[2] | F[1] | F[0] | | |
| 6 | XTAL Divider R-Divider | Write | 0x05 | XD[2] | XD[1] | XD[0] | R[4] | R[3] | R[2] | R[1] | R[0] | | |
| 7 | PLL | Write | 0x06 | D24 | CPS 0 | ICP 1 | X | X | X | X | X | | |
| 8 | VCO | Write | 0x07 | VCO[4] | VCO[3] | VCO[2] | VCO[1] | VCO[0] | VAS | ADL | ADE | | |
| 9 | LPF | Write | 0x08 | LP[7] | LP[6] | LP[5] | LP[4] | LP[3] | LP[2] | LP[1] | LP[0] | | |
| 10 | Control | Write | 0x09 | STBY | X | PWDN | X | BBG[3] | BBG[2] | BBG[1] | BBG[0] | | |
| 11 | Shutdown | Write | 0x0A | X | PLL | DIV | VCO | BB | RFMIX | RFVG | FE | | |
| 12 | Test | Write | 0x0B | CPTST[2] 0 | CPTST[1] 0 | CPTST[0] 0 | X | TURBO 1 | LD MUX[2] 0 | LD MUX[1] 0 | LD MUX[0] 0 | | |
| 13 | Status Byte-1 | Read | 0x0C | POR | VASA | VASE | LD | X | X | X | X | | |
| 14 | Status Byte-2 | Read | 0x0D | VCOSBR[4] | VCOSBR[3] | VCOSBR[2] | VCOSBR[1] | VCOSBR[0] | ADC[2] | ADC[1] | ADC[0] | | |

X = Don't care.

0 = Set to 0 for factory-tested operation.

1 = Set to 1 for factory-tested operation.

Complete, Direct-Conversion Tuner for DVB-S2 Applications

Table 2. N-Divider MSB Register

| BIT NAME | BIT LOCATION (0 = LSB) | DEFAULT | FUNCTION |
|----------|------------------------|---------|--|
| FRAC | 7 | 1 | Users must program to 1 upon powering up the device. |
| N[14:8] | 6–0 | 0000000 | Sets the most significant bits of the PLL integer-divide number (N). N can range from 19 to 251. |

Table 3. N-Divider LSB Register

| BIT NAME | BIT LOCATION (0 = LSB) | DEFAULT | FUNCTION |
|----------|------------------------|----------|---|
| N[7:0] | 7–0 | 00100011 | Sets the least significant bits of the PLL integer-divide number. N can range from 19 to 251. |

Table 4. Charge-Pump Register

| BIT NAME | BIT LOCATION (0 = LSB) | DEFAULT | FUNCTION |
|------------|------------------------|---------|---|
| CPMP[1:0] | 7–6 | 00 | Charge-pump minimum pulse width. Users must program to 00 upon powering up the device. |
| CPLIN[1:0] | 5–4 | 00 | Controls charge-pump linearity. Users must program to 00 upon powering up the device. |
| F[19:16] | 3–0 | 0010 | Sets the 4 most significant bits of the PLL fractional divide number. Default value is F = 194,180 decimal. |

Table 5. F-Divider MSB Register

| BIT NAME | BIT LOCATION (0 = LSB) | DEFAULT | FUNCTION |
|----------|------------------------|----------|---|
| F[15:8] | 7–0 | 11110110 | Sets the most significant bits of the PLL fractional-divide number (F). Default value is F = 194,180 decimal. |

Table 6. F-Divider LSB Register

| BIT NAME | BIT LOCATION (0 = LSB) | DEFAULT | FUNCTION |
|----------|------------------------|----------|--|
| F[7:0] | 7–0 | 10000100 | Sets the least significant bits of the PLL fractional-divide number (F). Default value is F = 194,180 decimal. |

Table 7. XTAL Buffer and Reference Divider Register

| BIT NAME | BIT LOCATION (0 = LSB) | DEFAULT | FUNCTION |
|----------|------------------------|---------|---|
| XD[2:0] | 7–5 | 000 | Sets the crystal-divider setting. 000 = Divide by 1. 001 = Divide by 2. 011 = Divide by 3. 100 = Divide by 4. 101 through 110 = All divide values from 5 (101) to 7 (110). 111 = Divide by 8. |
| R[4:0] | 4–0 | 00001 | Sets the PLL reference-divider (R) number. Users must program to 00001 upon powering up the device. 00001 = Divide by 1; other values are not tested. |

Complete, Direct-Conversion Tuner for DVB-S2 Applications

MAX2112

Table 8. PLL Register

| BIT NAME | BIT LOCATION (0 = LSB) | DEFAULT | FUNCTION |
|----------|------------------------|---------|---|
| D24 | 7 | 1 | VCO divider setting. 0 = Divide by 2. 1 = Divide by 4 (default). |
| CPS | 6 | 0 | Charge-pump current mode. Users must program to 0 upon powering up the device. 0 = Charge-pump current controlled by ICP bit. 1 = Charge-pump current controlled by VCO autoselect (VAS). |
| ICP | 5 | 0 | Charge-pump current. Users must program to 1 upon powering up the device. 0 = 600µA typical. 1 = 1200µA typical. |
| X | 4-0 | X | Don't care. |

Table 9. VCO Register

| BIT NAME | BIT LOCATION (0 = LSB) | DEFAULT | FUNCTION |
|----------|------------------------|---------|---|
| VCO[4:0] | 7-3 | 11001 | Controls which VCO is activated when using manual VCO programming mode. This also serves as the starting point for the VCO autoselection (VAS) mode. |
| VAS | 2 | 1 | VCO autoselection (VAS) circuit. 0 = Disable VCO selection must be programmed through I ² C. 1 = Enable VCO selection controlled by autoselection circuit. |
| ADL | 1 | 0 | Enables or disables the VCO tuning voltage ADC latch when the VCO autoselect mode (VAS) is disabled. 0 = Disables the ADC latch. 1 = Latches the ADC value. |
| ADE | 0 | 0 | Enables or disables VCO tuning voltage ADC read when the VCO autoselect mode (VAS) is disabled. 0 = Disables ADC read. 1 = Enables ADC read. |

Table 10. Lowpass Filter Register

| BIT NAME | BIT LOCATION (0 = LSB) | DEFAULT | FUNCTION |
|----------|------------------------|----------|---|
| LPF[7:0] | 7-0 | 01001011 | Sets the baseband lowpass filter 3dB corner frequency. $f_{-3dB} = 4\text{MHz} + (\text{LPF}[3:0]_{\text{dec}} - 12) \times 290\text{kHz}$. Default value equates to $f_{-3dB} = 22.27\text{MHz}$ typical. |

Complete, Direct-Conversion Tuner for DVB-S2 Applications

Table 11. Control Register

| BIT NAME | BIT LOCATION (0 = LSB) | DEFAULT | FUNCTION |
|----------|------------------------|---------|--|
| STBY | 7 | 0 | Software standby control. 0 = Normal operation. 1 = Disables the signal path and frequency synthesizer leaving only the 2-wire bus, crystal oscillator, XTALOUT buffer, and XTALOUT buffer divider active. |
| X | 6 | X | Don't care. |
| PWDN | 5 | 0 | Software power-down control. 0 = Normal operation. 1 = Shuts down the entire chip, but leaves the 2-wire bus active and maintains the current register states. |
| X | 4 | X | Don't care. |
| BBG[3:0] | 3-0 | 0000 | Baseband gain setting (1dB typical per step). 0000 = Minimum gain (0dB, default). ... 1111 = Maximum gain (15dB typical). |

Table 12. Shutdown Register

| BIT NAME | BIT LOCATION (0 = LSB) | DEFAULT | FUNCTION |
|----------|------------------------|---------|---|
| X | 7 | X | Don't care. |
| PLL | 6 | 0 | PLL enable. 0 = Normal operation. 1 = Shuts down the PLL. |
| DIV | 5 | 0 | Divider enable. 0 = Normal operation. 1 = Shuts down the divider. |
| VCO | 4 | 0 | VCO enable. 0 = Normal operation. 1 = Shuts down the VCO. |
| BB | 3 | 0 | Baseband enable. 0 = Normal operation. 1 = Shuts down the baseband. |
| RFMIX | 2 | 0 | RF mixer enable. 0 = Normal operation. 1 = Shuts down the RF mixer. |
| RFVGA | 1 | 0 | RF VGA enable. 0 = Normal operation. 1 = Shuts down the RF VGA. |
| FE | 0 | 0 | Front-end enable. 0 = Normal operation. 1 = Shuts down the front-end. |

Complete, Direct-Conversion Tuner for DVB-S2 Applications

MAX2112

Table 13. Test Register

| BIT NAME | BIT LOCATION (0 = LSB) | DEFAULT | FUNCTION |
|------------|------------------------|---------|---|
| CPTST[2:0] | 7-5 | 000 | Charge-pump test modes. 000 = Normal operation (default). |
| X | 4 | X | Don't care. |
| TURBO | 3 | 0 | Charge-pump fast lock. Users must program to 1 after powering up the device. |
| LDMUX[2:0] | 2-0 | 000 | REFOUT output. 000 = Normal operation. Other values are not tested. |

Table 14. Status Byte-1 Register

| BIT NAME | BIT LOCATION (0 = LSB) | FUNCTION |
|----------|------------------------|---|
| POR | 7 | Power-on reset status. 0 = Chip status register has been read with a stop condition since last power-on. 1 = Power-on reset (power cycle) has occurred. Default values have been loaded in registers. |
| VASA | 6 | Indicates whether VCO autoselection was successful. 0 = Indicates the autoselect function is disabled or unsuccessful VCO selection. 1 = Indicates successful VCO autoselection. |
| VASE | 5 | Status indicator for the autoselect function. 0 = Indicates the autoselect function is active. 1 = Indicates the autoselect process is inactive. |
| LD | 4 | PLL lock detector. 0 = Unlocked. 1 = Locked. |
| X | 3:0 | Don't care. |

Table 15. Status Byte-2 Register

| BIT NAME | BIT LOCATION (0 = LSB) | FUNCTION |
|-------------|------------------------|--|
| VCOSBR[4:0] | 7-3 | VCO band readback. |
| ADC[2:0] | 2-0 | VAS ADC output readback. 000 = Out of lock. 001 = Locked. 010 = VAS locked. 101 = VAS locked. 110 = Locked. 111 = Out of lock. |

Complete, Direct-Conversion Tuner for DVB-S2 Applications

2-Wire Serial Interface

The MAX2112 uses a 2-wire I²C-compatible serial interface consisting of a serial-data line (SDA) and a serial-clock line (SCL). SDA and SCL facilitate bidirectional communication between the MAX2112 and the master at clock frequencies up to 400kHz. The master initiates a data transfer on the bus and generates the SCL signal to permit data transfer. The MAX2112 behaves as a slave device that transfers and receives data to and from the master. SDA and SCL must be pulled high with external pullup resistors (1kΩ or greater) for proper bus operation.

One bit is transferred during each SCL clock cycle. A minimum of nine clock cycles is required to transfer a byte in or out of the MAX2112 (8 bits and an ACK/NACK). The data on SDA must remain stable during the high period of the SCL clock pulse. Changes in SDA while SCL is high and stable are considered control signals (see the *START and STOP Conditions* section). Both SDA and SCL remain high when the bus is not busy.

START and STOP Conditions

The master initiates a transmission with a START condition (S), which is a high-to-low transition on SDA while SCL is high. The master terminates a transmission with a STOP condition (P), which is a low-to-high transition on SDA while SCL is high.

Acknowledge and Not-Acknowledge Conditions

Data transfers are framed with an acknowledge bit (ACK) or a not-acknowledge bit (NACK). Both the master and the MAX2112 (slave) generate acknowledge bits. To generate an acknowledge, the receiving device must pull SDA low before the rising edge of the acknowledge-related clock pulse (ninth pulse) and keep it low during the high period of the clock pulse.

To generate a not-acknowledge condition, the receiver allows SDA to be pulled high before the rising edge of the acknowledge-related clock pulse, and leaves SDA high during the high period of the clock pulse. Monitoring the acknowledge bits allows for detection of unsuccessful data transfers. An unsuccessful data transfer happens if a receiving device is busy or if a system fault has occurred. In the event of an unsuccessful data transfer, the bus master must reattempt communication at a later time.

Slave Address

The MAX2112 has a 7-bit slave address that must be sent to the device following a START condition to initiate communication. The slave address is internally programmed to 1100000. The eighth bit (R/W) following the 7-bit address determines whether a read or write operation occurs.

The MAX2112 continuously awaits a START condition followed by its slave address. When the device recognizes its slave address, it acknowledges by pulling the SDA line low for one clock period; it is ready to accept or send data depending on the R/W bit (Figure 1).

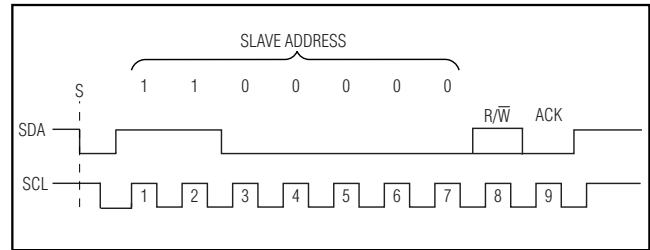

Figure 1. MAX2112 Slave Address Byte

Write Cycle

When addressed with a write command, the MAX2112 allows the master to write to a single register or to multiple successive registers.

A write cycle begins with the bus master issuing a START condition followed by the seven slave address bits and a write bit (R/W = 0). The MAX2112 issues an ACK if the slave address byte is successfully received. The bus master must then send to the slave the address of the first register it wishes to write to (see Table 1 for register addresses). If the slave acknowledges the address, the master can then write one byte to the register at the specified address. Data is written beginning with the most significant bit. The MAX2112 again issues an ACK if the data is successfully written to the register. The master can continue to write data to the successive internal registers with the MAX2112 acknowledging each successful transfer, or it can terminate transmission by issuing a STOP condition. The write cycle does not terminate until the master issues a STOP condition.

| START | WRITE DEVICE ADDRESS | R/W | ACK | WRITE REGISTER ADDRESS | ACK | WRITE DATA TO REGISTER 0x00 | ACK | WRITE DATA TO REGISTER 0x01 | ACK | WRITE DATA TO REGISTER 0x02 | ACK | STOP |
|-------|----------------------|-----|-----|------------------------|-----|-----------------------------|-----|-----------------------------|-----|-----------------------------|-----|------|
| | 1100000 | 0 | — | 0x00 | — | 0x0E | — | 0xD8 | — | 0xE1 | — | |

Figure 2. Example: Write Registers 0 through 2 with 0x0E, 0xD8, and 0xE1, respectively.

Complete, Direct-Conversion Tuner for DVB-S2 Applications

| START | WRITE DEVICE ADDRESS | R/W | ACK | READ FROM STATUS BYTE-1 REGISTER | ACK | READ FROM STATUS BYTE-2 REGISTER | ACK/NACK | STOP |
|-------|----------------------|-----|-----|----------------------------------|-----|----------------------------------|----------|------|
| | 1100000 | 1 | — | — | — | — | — | |

Figure 3. Example: Receive Data from Read Registers

Read Cycle

There are only two registers on the MAX2112 that are available to be read by the master. When addressed with a read command, the MAX2112 sends back the contents of both read registers (Status Byte-1 and Status Byte-2).

A read cycle begins with the bus master issuing a START condition followed by the seven slave address bits and a read bit (R/W = 1). If the slave address byte is successfully received, the MAX2112 issues an ACK. The master then reads the contents of the Status Byte-1 register, beginning with the most significant bit, and acknowledges if the byte is received successfully. Next, the master reads the contents of the Status Byte-2 register. At this point the master can issue an ACK or NACK and then a STOP condition to terminate the read cycle.

Application Information

The MAX2112 downconverts RF signals in the 925MHz to 2175MHz range directly to the baseband I/Q signals. The devices are targeted for digital DBS tuner applications.

RF Input

The RF input of the MAX2112 is internally matched to 75Ω. Only a DC-blocking capacitor is needed. See the *Typical Application Circuit*.

RF Gain Control

The MAX2112 features a variable-gain low-noise amplifier providing 73dB of RF gain range. The voltage control (VGC) range is 0.5V (minimum attenuation) to 2.7V (maximum attenuation).

Baseband Variable-Gain Amplifier

The receiver baseband variable-gain amplifiers provide 15dB of gain control range programmable in 1dB steps. The VGA gain can be serially programmed through the SPI interface by setting bits BBG[3:0] in the Control register.

Baseband Lowpass Filter

The MAX2112 includes a programmable on-chip 7th-order Butterworth filter. The filter -3dB corner frequency can be adjusted from approximately 4MHz to 40MHz by programming the LPF[7:0] register using the following equation:

$$LPF[3:0]_{dec} = (f_{-3dB} - 4MHz) / 0.29MHz + 12,$$

where f_{-3dB} is in units of MHz.

Total device supply current depends on the filter BW setting. See Supply Current vs. Baseband Filter Cutoff Frequency in the *Typical Operating Characteristics* for more information.

DC Offset Cancellation

The DC offset cancellation is required to maintain the I/Q output dynamic range. Connecting an external capacitor between IDC+ and IDC- forms a highpass filter for the I channel and an external capacitor between QDC+ and QDC- forms a highpass filter for the Q channel. Keep the value of the external capacitor less than 47nF to form a typical highpass corner of 250Hz.

XTAL Oscillator

The MAX2112 contains an internal reference oscillator, reference output divider, and output buffer. All that is required is to connect a crystal through a series 1nF capacitor. Use a crystal with an ESR less than 60Ω for a 27MHz crystal. The typical input capacitance is 16pF. Contact the factory for more information if not using a 27MHz crystal.

VCO Autoselect (VAS)

The MAX2112 includes 24 VCOs. The local oscillator frequency can be manually selected by programming the VCO[4:0] bits in the VCO register. The selected VCO is reported in the Status Byte-2 register (see Table 15).

Alternatively, the MAX2112 can be set to autonomously choose a VCO by setting the VAS bit in the VCO register to logic-high. The VAS routine is initiated once the F-Divider LSB register word (REG 5) is loaded.

In the event that only the N-divider register or F-divider MSB word is changed, the F-divider LSB word must also be loaded last to initiate the VCO autoselect function. The VCO value programmed in the VCO[4:0] register serves as the starting point for the automatic VCO selection process.

During the selection process, the VASE bit in the Status Byte-1 register is cleared to indicate the autoselection function is active. Upon successful completion, bits VASE and VASA are set and the VCO selected is reported in the Status Byte-2 register (see Table 15). If the search is unsuccessful, VASA is cleared and VASE is set. This indicates that searching has ended but no good VCO has been found, and occurs when trying to tune to a frequency outside the VCO's specified frequency range.

Complete, Direct-Conversion Tuner for DVB-S2 Applications

Refer to the MAX2112/MAX2120 VCO Autoselect (VAS) Application Note for more information.

3-Bit ADC

The MAX2112 has an internal 3-bit ADC connected to the VCO tune pin (VTUNE). This ADC can be used for checking the lock status of the VCOs.

Table 16 summarizes the ADC output bits and the VCO lock indication. The VCO autoselect routine only selects a VCO in the "VAS locked" range. This allows room for a VCO to drift over temperature and remain in a valid "locked" range.

The ADC must first be enabled by setting the ADE bit in the VCO register. The ADC reading is latched by a subsequent programming of the ADC latch bit (ADL = 1). The ADC value is reported in the Status Byte-2 register (see Table 15).

Table 16. ADC Trip Points and Lock Status

| ADC[2:0] | LOCK STATUS |
|----------|-------------|
| 000 | Out of lock |
| 001 | Locked |
| 010 | VAS locked |
| 101 | VAS locked |
| 110 | Locked |
| 111 | Out of lock |

Table 17. Power-Down Modes

| MODE | POWER-DOWN CONTROL | | CIRCUIT STATES | | | DESCRIPTION |
|------------|--------------------|----------|----------------|------------------|------|---|
| | PWDN BIT | STBY BIT | SIGNAL PATH | 2-WIRE INTERFACE | XTAL | |
| Normal | 0 | 0 | On | On | On | All circuits active. |
| Power-Down | 1 | 0 | Off | On | Off | 2-wire interface is active. |
| Standby | 0 | 1 | Off | On | On | 2-wire interface, XTAL, and XTAL buffer/divider are active. |

Power-Down and Standby Modes

The MAX2112 features normal operating mode, power-down mode, and standby mode using the I²C interface. Setting a logic-high to the PWDN bit in the Control register enables power-down. In this mode, all circuitries except for the 2-wire-compatible bus are disabled, allowing for programming of the MAX2112 registers while in power-down. Setting a logic-high to the STBY bit in the Control register puts the device into standby mode, during which only the 2-wire-compatible bus, the crystal oscillator, the XTAL buffer, and the XTAL buffer divider are active.

In all cases, register settings loaded prior to entering shutdown are saved upon transition back to active mode. Default register values are provided for the user's convenience only. It is the user's responsibility to load all the registers no sooner than 100μs after the device is powered up. The various power-down modes are summarized in Table 17.

Layout Considerations

The MAX2112 EV kit serves as a guide for PCB layout. Keep RF signal lines as short as possible to minimize losses and radiation. Use controlled impedance on all high-frequency traces. For proper operation, the exposed paddle must be soldered evenly to the board's ground plane. Use abundant vias beneath the exposed paddle for maximum heat dissipation. Use abundant ground vias between RF traces to minimize undesired coupling. Bypass each V_{CC} pin to ground with a 1nF capacitor placed as close as possible to the pin.

Complete, Direct-Conversion Tuner for DVB-S2 Applications

Typical Application Circuit

MAX2112

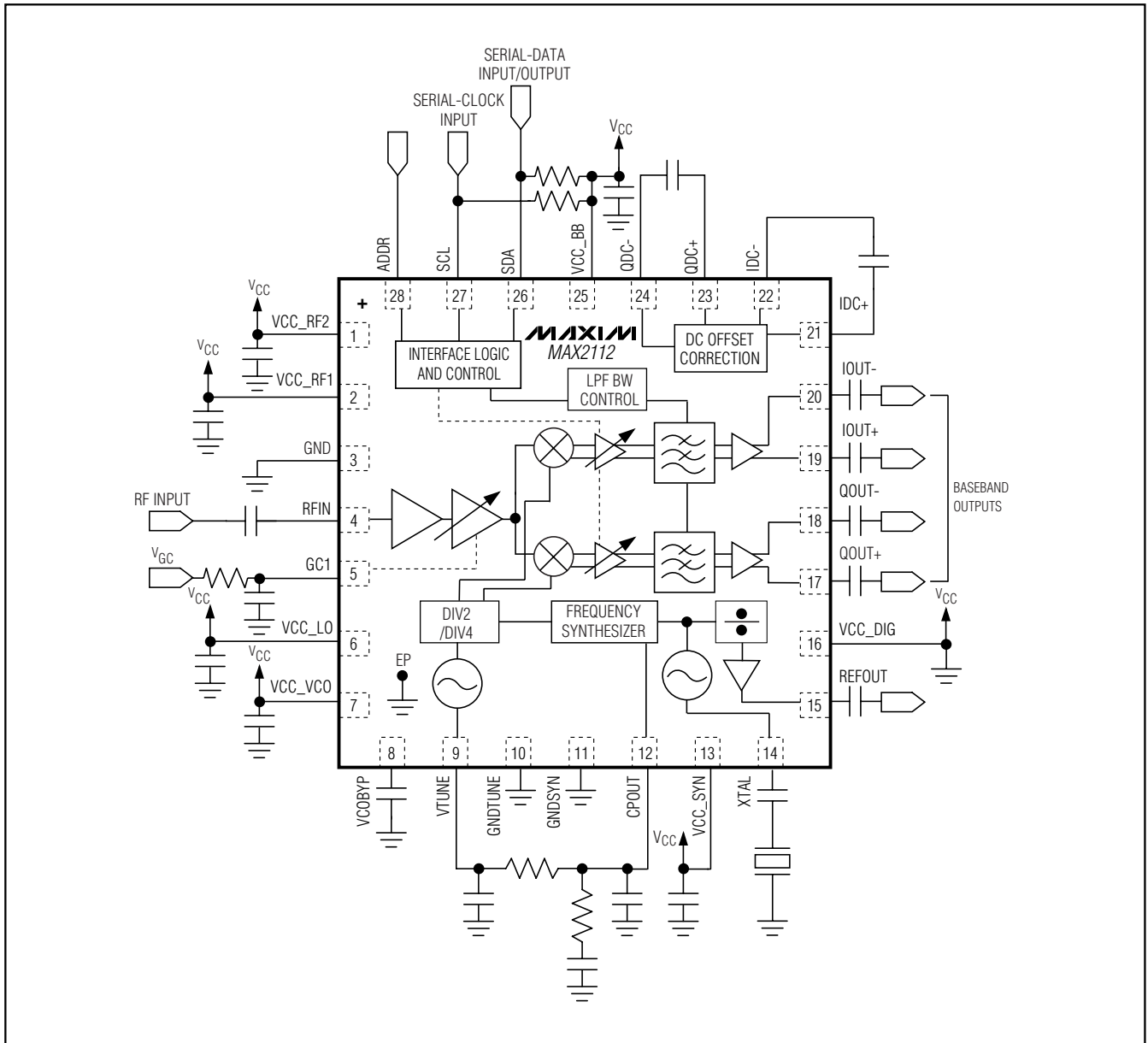

Chip Information

PROCESS: BiCMOS

Complete, Direct-Conversion Tuner for DVB-S2 Applications

Package Information (continued)

(The package drawing(s) in this data sheet may not reflect the most current specifications. For the latest package outline information go to www.maxim-ic.com/packages.)

MAX2112

| COMMON DIMENSIONS | | | | | | | | | | | | | | | |
|-------------------|-----------|------|------|-----------|------|------|-----------|------|------|-----------|------|------|-----------|------|------|
| PKG. | 16L 5x5 | | | 20L 5x5 | | | 28L 5x5 | | | 32L 5x5 | | | 40L 5x5 | | |
| SYMBOL | MIN. | NOM. | MAX. | MIN. | NOM. | MAX. | MIN. | NOM. | MAX. | MIN. | NOM. | MAX. | MIN. | NOM. | MAX. |
| A | 0.70 | 0.75 | 0.80 | 0.70 | 0.75 | 0.80 | 0.70 | 0.75 | 0.80 | 0.70 | 0.75 | 0.80 | 0.70 | 0.75 | 0.80 |
| A1 | 0 | 0.02 | 0.05 | 0 | 0.02 | 0.05 | 0 | 0.02 | 0.05 | 0 | 0.02 | 0.05 | 0 | 0.02 | 0.05 |
| A2 | 0.20 REF. | | | 0.20 REF. | | | 0.20 REF. | | | 0.20 REF. | | | 0.20 REF. | | |
| b | 0.25 | 0.30 | 0.35 | 0.25 | 0.30 | 0.35 | 0.20 | 0.25 | 0.30 | 0.20 | 0.25 | 0.30 | 0.15 | 0.20 | 0.25 |
| D | 4.90 | 5.00 | 5.10 | 4.90 | 5.00 | 5.10 | 4.90 | 5.00 | 5.10 | 4.90 | 5.00 | 5.10 | 4.90 | 5.00 | 5.10 |
| E | 4.90 | 5.00 | 5.10 | 4.90 | 5.00 | 5.10 | 4.90 | 5.00 | 5.10 | 4.90 | 5.00 | 5.10 | 4.90 | 5.00 | 5.10 |
| e | 0.60 BSC. | | | 0.65 BSC. | | | 0.50 BSC. | | | 0.50 BSC. | | | 0.40 BSC. | | |
| k | 0.25 | - | - | 0.25 | - | - | 0.25 | - | - | 0.25 | - | - | 0.25 | - | - |
| L | 0.30 | 0.40 | 0.50 | 0.45 | 0.55 | 0.65 | 0.45 | 0.55 | 0.65 | 0.30 | 0.40 | 0.50 | 0.30 | 0.40 | 0.50 |
| N | 16 | | | 20 | | | 28 | | | 32 | | | 40 | | |
| ND | 4 | | | 5 | | | 7 | | | 8 | | | 10 | | |
| NE | 4 | | | 5 | | | 7 | | | 8 | | | 10 | | |
| JEDEC | WHHB | | | WHHC | | | WHHD-1 | | | WHHD-2 | | | ----- | | |

| EXPOSED PAD VARIATIONS | | | | | | |
|------------------------|------|------|------|------|------|------|
| PKG. CODES | D2 | | | E2 | | |
| | MIN. | NOM. | MAX. | MIN. | NOM. | MAX. |
| T1655-2 | 3.00 | 3.10 | 3.20 | 3.00 | 3.10 | 3.20 |
| T1655-3 | 3.00 | 3.10 | 3.20 | 3.00 | 3.10 | 3.20 |
| T1655N-1 | 3.00 | 3.10 | 3.20 | 3.00 | 3.10 | 3.20 |
| T2055-3 | 3.00 | 3.10 | 3.20 | 3.00 | 3.10 | 3.20 |
| T2055-4 | 3.00 | 3.10 | 3.20 | 3.00 | 3.10 | 3.20 |
| T2055-5 | 3.15 | 3.25 | 3.35 | 3.15 | 3.25 | 3.35 |
| T2055M-5 | 3.15 | 3.25 | 3.35 | 3.15 | 3.25 | 3.35 |
| T2855-3 | 3.15 | 3.25 | 3.35 | 3.15 | 3.25 | 3.35 |
| T2855-4 | 2.60 | 2.70 | 2.80 | 2.60 | 2.70 | 2.80 |
| T2855-5 | 2.60 | 2.70 | 2.80 | 2.60 | 2.70 | 2.80 |
| T2855-6 | 3.15 | 3.25 | 3.35 | 3.15 | 3.25 | 3.35 |
| T2855-7 | 2.60 | 2.70 | 2.80 | 2.60 | 2.70 | 2.80 |
| T2855-8 | 3.15 | 3.25 | 3.35 | 3.15 | 3.25 | 3.35 |
| T2855N-1 | 3.15 | 3.25 | 3.35 | 3.15 | 3.25 | 3.35 |
| T3255-3 | 3.00 | 3.10 | 3.20 | 3.00 | 3.10 | 3.20 |
| T3255-4 | 3.00 | 3.10 | 3.20 | 3.00 | 3.10 | 3.20 |
| T3255M-4 | 3.00 | 3.10 | 3.20 | 3.00 | 3.10 | 3.20 |
| T3255-5 | 3.00 | 3.10 | 3.20 | 3.00 | 3.10 | 3.20 |
| T3255N-1 | 3.00 | 3.10 | 3.20 | 3.00 | 3.10 | 3.20 |
| T4055-1 | 3.40 | 3.50 | 3.60 | 3.40 | 3.50 | 3.60 |
| T4055-2 | 3.40 | 3.50 | 3.60 | 3.40 | 3.50 | 3.60 |

NOTES:

- DIMENSIONING & TOLERANCING CONFORM TO ASME Y14.5M-1994.
- ALL DIMENSIONS ARE IN MILLIMETERS. ANGLES ARE IN DEGREES.
- N IS THE TOTAL NUMBER OF TERMINALS.
- THE TERMINAL #1 IDENTIFIER AND TERMINAL NUMBERING CONVENTION SHALL CONFORM TO JEDEC 95-1 SPP-012. DETAILS OF TERMINAL #1 IDENTIFIER ARE OPTIONAL, BUT MUST BE LOCATED WITHIN THE ZONE INDICATED. THE TERMINAL #1 IDENTIFIER MAY BE EITHER A MOLD OR MARKED FEATURE.
- DIMENSION b APPLIES TO METALLIZED TERMINAL AND IS MEASURED BETWEEN 0.25 mm AND 0.30 mm FROM TERMINAL TIP.
- ND AND NE REFER TO THE NUMBER OF TERMINALS ON EACH D AND E SIDE RESPECTIVELY.
- DEPOPULATION IS POSSIBLE IN A SYMMETRICAL FASHION.
- COPLANARITY APPLIES TO THE EXPOSED HEAT SINK SLUG AS WELL AS THE TERMINALS.
- DRAWING CONFORMS TO JEDEC MO220, EXCEPT EXPOSED PAD DIMENSION FOR T2855-3, T2855-6, T4055-1 AND T4055-2.
- WARPAGE SHALL NOT EXCEED 0.10 mm.
- MARKING IS FOR PACKAGE ORIENTATION REFERENCE ONLY.
- NUMBER OF LEADS SHOWN ARE FOR REFERENCE ONLY.
- LEAD CENTERLINES TO BE AT TRUE POSITION AS DEFINED BY BASIC DIMENSION 'e', ±0.05.

—DRAWING NOT TO SCALE—



TITLE PACKAGE OUTLINE,
16, 20, 28, 32, 40L THIN QFN, 5x5x0.8mm

| | | | |
|----------|---------------------------------|-----------|-----|
| APPROVAL | DOCUMENT CONTROL NO. 21-0140 | REV. K | 2/2 |
|----------|---------------------------------|-----------|-----|

Maxim cannot assume responsibility for use of any circuitry other than circuitry entirely embodied in a Maxim product. No circuit patent licenses are implied. Maxim reserves the right to change the circuitry and specifications without notice at any time.

Maxim Integrated Products, 120 San Gabriel Drive, Sunnyvale, CA 94086 408-737-7600 19

© 2007 Maxim Integrated Products

MAXIM is a registered trademark of Maxim Integrated Products, Inc.