

MAXIM

500mA Low-Dropout Linear Regulator in SOT23

MAX1818

General Description

The MAX1818 low-dropout linear regulator operates from a +2.5V to +5.5V supply and delivers a guaranteed 500mA load current with low 120mV dropout. The high-accuracy ($\pm 1\%$) output voltage is preset at an internally trimmed voltage (see *Selector Guide*) or can be adjusted from 1.25V to 5.0V with an external resistive divider.

An internal PMOS pass transistor allows the low 125 μ A supply current to remain independent of load, making this device ideal for portable battery-operated equipment such as personal digital assistants (PDAs), cellular phones, cordless phones, base stations, and notebook computers.

Other features include an active-low open-drain reset output that indicates when the output is out of regulation, a 0.1 μ A shutdown, short-circuit protection, and thermal shutdown protection. The device is available in a miniature 800mW 6-pin SOT23 package.

Applications

Notebook Computers
Cellular and Cordless Telephones
Personal Digital Assistants (PDAs)
Palmtop Computers
Base Stations
USB Hubs
Docking Stations

Pin Configuration

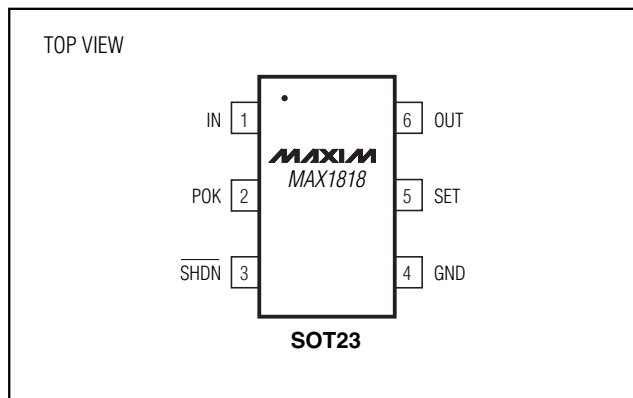

Features

- ◆ Guaranteed 500mA Output Current
- ◆ Low 120mV Dropout at 500mA
- ◆ $\pm 1\%$ Output Voltage Accuracy
Preset at 1.5V, 1.8V, 2.0V, 2.5V, 3.3V, 5V
Adjustable from 1.25V to 5.0V
- ◆ Power OK Output
- ◆ Low 125 μ A Ground Current
- ◆ 0.1 μ A Shutdown Current
- ◆ Thermal Overload Protection
- ◆ Output Current Limit
- ◆ Tiny 800mW 6-Pin SOT23 Package

Ordering Information

| PART* | TEMP RANGE | PIN-PACKAGE |
|----------------|----------------|-------------|
| MAX1818EUAT_ _ | -40°C to +85°C | 6 SOT23-6 |

*Insert the desired two-digit suffix (see *Selector Guide*) into the blanks to complete the part number.

Note: The MAX1818 requires a special solder temperature profile described in the Absolute Maximum Ratings section.

Selector Guide

| PART AND SUFFIX | V _{OUT} | SOT23 TOP MARK |
|-----------------|------------------|----------------|
| MAX1818EUT15 | 1.5V or Adj | AASO |
| MAX1818EUT18 | 1.8V or Adj | AANU |
| MAX1818EUT20 | 2.0V or Adj | AANV |
| MAX1818EUT25 | 2.5V or Adj | AANF |
| MAX1818EUT33 | 3.3V or Adj | AANG |
| MAX1818EUT50 | 5.0V or Adj | AANH |

Typical Operating Circuit

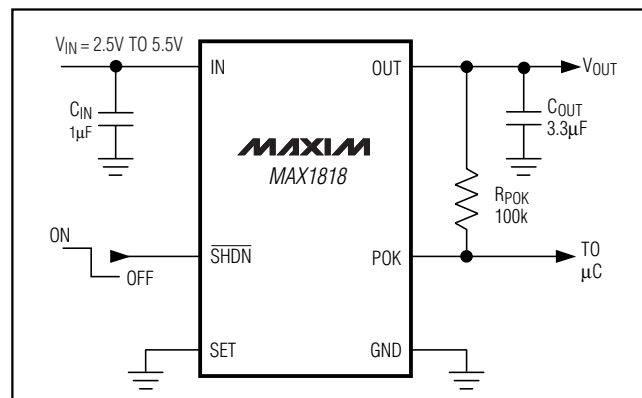
**MAXIM**

Maxim Integrated Products 1

For pricing, delivery, and ordering information, please contact Maxim/Dallas Direct! at 1-888-629-4642, or visit Maxim's website at www.maxim-ic.com.

500mA Low-Dropout Linear Regulator in SOT23

ABSOLUTE MAXIMUM RATINGS

IN, $\overline{\text{SHDN}}$, POK, SET to GND-0.3V to +6V
 OUT to GND-0.3V to ($V_{\text{IN}} + 0.3\text{V}$)
 Output Short-Circuit Duration1min
 Continuous Power Dissipation ($T_{\text{A}} = +70^{\circ}\text{C}$) (Note 1)
 6-Pin SOT23 (derate 10mW/ $^{\circ}\text{C}$ above $+70^{\circ}\text{C}$)800mW

Operating Temperature Range -40°C to $+85^{\circ}\text{C}$
 Junction Temperature $+150^{\circ}\text{C}$
 Storage Temperature Range -65°C to $+150^{\circ}\text{C}$
 Lead Temperature (soldering, 10s) (Note 2) $+300^{\circ}\text{C}$

Note 1: Thermal properties are specified with product mounted on PC board with one square-inch of copper area and still air. With minimal copper, the SOT23 package dissipates 712mW at $+70^{\circ}\text{C}$. With a quarter square inch of copper, it will dissipate 790mW at $+70^{\circ}\text{C}$. Copper should be equally shared between the IN, OUT, and GND pins.

Note 2: This device is constructed using a unique set of packaging techniques that imposes a limit on the thermal profile to which the device can be exposed during board-level solder attach and rework. The limit permits only the use of the solder profiles recommended in the industry standard specification, IPC JEDEC-J-STD-020A, paragraph 7.6, Table 3 for the IR/VPR and convection reflow. Preheating is required. Hand or wave soldering is not allowed.

Stresses beyond those listed under "Absolute Maximum Ratings" may cause permanent damage to the device. These are stress ratings only, and functional operation of the device at these or any other conditions beyond those indicated in the operational sections of the specifications is not implied. Exposure to absolute maximum rating conditions for extended periods may affect device reliability.

ELECTRICAL CHARACTERISTICS

($V_{\text{IN}} = V_{\text{OUT}} + 500\text{mV}$ or $V_{\text{IN}} = +2.5\text{V}$, whichever is greater; $\overline{\text{SHDN}} = \text{IN}$, $T_{\text{A}} = -40^{\circ}\text{C}$ to $+85^{\circ}\text{C}$, unless otherwise noted. Typical values are at $T_{\text{A}} = +25^{\circ}\text{C}$.) (Note 3)

| PARAMETER | SYMBOL | CONDITIONS | | MIN | TYP | MAX | UNITS |
|--|----------------------------------|---|---|-------|-------|-------|---------------|
| Input Voltage | V_{IN} | | | 2.5 | | 5.5 | V |
| Input Undervoltage Lock-Out | V_{UVLO} | Rising, 75mV hysteresis | | 2.0 | 2.15 | 2.3 | V |
| Output Voltage Accuracy (Preset Mode) | V_{OUT} | $I_{\text{OUT}} = 100\text{mA}$, $T_{\text{A}} = +25^{\circ}\text{C}$, $V_{\text{OUT}} \geq 2.0\text{V}$ | | -1 | | +1 | % |
| | | $I_{\text{OUT}} = 100\text{mA}$, $V_{\text{OUT}} < 2.0\text{V}$ | | -1.5 | | +1.5 | |
| | | $I_{\text{OUT}} = 100\text{mA}$, $T_{\text{A}} = -40^{\circ}\text{C}$ to $+85^{\circ}\text{C}$ | | -2.5 | | +2.5 | |
| | | $I_{\text{OUT}} = 1\text{mA}$ to 500mA , $V_{\text{IN}} > V_{\text{OUT}} + 0.5\text{V}$, $T_{\text{A}} = -40^{\circ}\text{C}$ to $+85^{\circ}\text{C}$ | | -3 | | +3 | |
| Adjustable Output Voltage Range | | | | 1.25 | | 5 | V |
| SET Voltage Threshold (Adjustable Mode) | V_{SET} | $V_{\text{IN}} = 2.7\text{V}$, $I_{\text{OUT}} = 100\text{mA}$, V_{OUT} set to 2.0V | $T_{\text{A}} = 0^{\circ}\text{C}$ to $+85^{\circ}\text{C}$ | 1.225 | 1.250 | 1.275 | V |
| | | | $T_{\text{A}} = -40^{\circ}\text{C}$ to $+85^{\circ}\text{C}$ | 1.213 | | 1.288 | |
| Guaranteed Output Current (RMS) | I_{OUT} | $V_{\text{IN}} \geq 2.7\text{V}$ | | 500 | | | mA |
| Short-Circuit Current Limit | I_{LIM} | $V_{\text{OUT}} = 0$, $V_{\text{IN}} \geq 2.7\text{V}$ | | 0.55 | 0.8 | 1.8 | A |
| In-Regulation Current Limit | | $V_{\text{OUT}} > 96\%$ of nominal value, $V_{\text{IN}} \geq 2.7\text{V}$ | | | 1.6 | | A |
| SET Dual Mode™ Threshold | | | | 50 | 100 | 150 | mV |
| SET Input Bias Current | I_{SET} | $V_{\text{SET}} = 1.25\text{V}$ | | -100 | | +100 | nA |
| Ground-Pin Current | I_{Q} | $I_{\text{OUT}} = 100\mu\text{A}$ | | | 125 | 250 | μA |
| | | $I_{\text{OUT}} = 500\text{mA}$ | | | 140 | | |
| Dropout Voltage (Note 4) | $V_{\text{IN}} - V_{\text{OUT}}$ | $I_{\text{OUT}} = 500\text{mA}$ | $V_{\text{OUT}} = 5\text{V}$ | | 100 | 220 | mV |
| | | | $V_{\text{OUT}} = 3.3\text{V}$ | | 120 | 215 | |
| | | | $V_{\text{OUT}} = 2.5\text{V}$ | | 210 | 360 | |
| Line Regulation | ΔV_{LNR} | V_{IN} from ($V_{\text{OUT}} + 100\text{mV}$) to 5.5V, $I_{\text{LOAD}} = 5\text{mA}$ | | -0.15 | 0 | +0.15 | %/V |

Dual Mode is a trademark of Maxim Integrated Products

500mA Low-Dropout Linear Regulator in SOT23

MAX1818

ELECTRICAL CHARACTERISTICS (continued)

($V_{IN} = V_{OUT} + 500\text{mV}$ or $V_{IN} = +2.5\text{V}$, whichever is greater; $\overline{\text{SHDN}} = \text{IN}$, $T_A = -40^\circ\text{C}$ to $+85^\circ\text{C}$, unless otherwise noted. Typical values are at $T_A = +25^\circ\text{C}$.) (Note 3)

| PARAMETER | SYMBOL | CONDITIONS | MIN | TYP | MAX | UNITS |
|---|------------------------------|--|-----|------|-----|---------------------|
| Load Regulation | ΔV_{LDR} | $I_{OUT} = 1\text{mA}$ to 500mA | | 0.4 | 1.0 | % |
| Output Voltage Noise | | 10Hz to 1MHz, $C_{OUT} = 3.3\mu\text{F}$ (ESR < 0.1Ω) | | 115 | | μV_{RMS} |
| SHUTDOWN | | | | | | |
| Shutdown Supply Current | I_{OFF} | $\overline{\text{SHDN}} = \text{GND}$, $V_{IN} = 5.5\text{V}$ | | 0.1 | 15 | μA |
| $\overline{\text{SHDN}}$ Input Threshold | V_{IH} | $2.5\text{V} < V_{IN} < 5.5\text{V}$ | 1.6 | | | V |
| | V_{IL} | $2.5\text{V} < V_{IN} < 5.5\text{V}$ | | | 0.6 | |
| $\overline{\text{SHDN}}$ Input Bias Current | $I_{\overline{\text{SHDN}}}$ | $\overline{\text{SHDN}} = \text{IN}$ or GND , $T_A = +25^\circ\text{C}$ | | 1 | 25 | nA |
| | | $T_A = +85^\circ\text{C}$ | | 5 | | |
| POK OUTPUT | | | | | | |
| POK Output Low Voltage | V_{OL} | POK sinking 1mA | | 0.01 | 0.1 | V |
| Operating Voltage Range for Valid POK | | POK sinking $100\mu\text{A}$ | 1.0 | | 5.5 | V |
| POK Output High Leakage Current | | POK = 5.5V , $T_A = +25^\circ\text{C}$ | | 1 | 25 | nA |
| | | $T_A = +85^\circ\text{C}$ | | 5 | | |
| POK Threshold | | Rising edge, referred to $V_{OUT(\text{NOMINAL})}$ | 90 | 93 | 96 | % |
| THERMAL PROTECTION | | | | | | |
| Thermal Shutdown Temperature | T_{SHDN} | | | 170 | | $^\circ\text{C}$ |
| Thermal Shutdown Hysteresis | ΔT_{SHDN} | | | 20 | | $^\circ\text{C}$ |

Note 3: All devices are 100% production tested at $T_A = +25^\circ\text{C}$. Limits over the operating temperature range are guaranteed by design.

Note 4: The Dropout Voltage is defined as $V_{IN} - V_{OUT}$, when V_{OUT} is 100mV below the value of V_{OUT} measured for $V_{IN} = V_{OUT(\text{NOM})} + 500\text{mV}$. Since the minimum input voltage is 2.5V , this specification is only meaningful when $V_{OUT(\text{NOM})} > 2.5\text{V}$. For $V_{OUT(\text{NOM})}$ between 2.5V and 3.5V , use the following equations: Typical Dropout = $-93\text{mV/V} \times V_{OUT(\text{NOM})} + 445\text{mV}$; Guaranteed Maximum Dropout = $-137\text{mV/V} \times V_{OUT(\text{NOM})} + 7004\text{mV}$. For $V_{OUT(\text{NOM})} > 3.5\text{V}$, Typical Dropout = 120mV ; Maximum Dropout = 220mV .

Typical Operating Characteristics

($V_{IN} = (V_{OUT} + 500\text{mV})$ or $+2.5\text{V}$, whichever is greater; $\overline{\text{SHDN}} = \text{IN}$, $C_{IN} = 1\mu\text{F}$, $C_{OUT} = 3.3\mu\text{F}$, $T_A = +25^\circ\text{C}$, unless otherwise noted.)

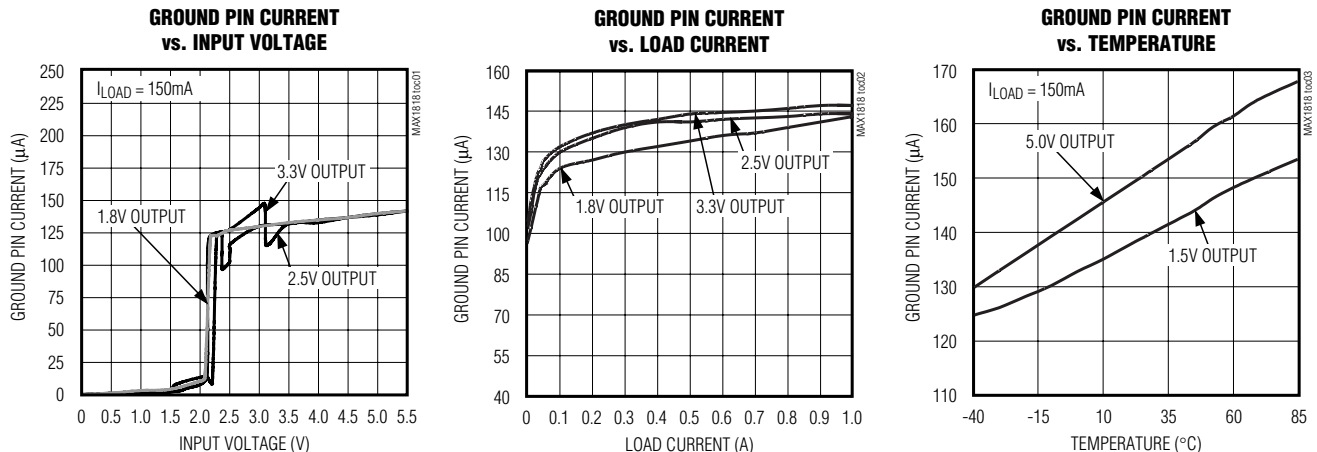

500mA Low-Dropout Linear Regulator in SOT23

Typical Operating Characteristics (continued)

($V_{IN} = (V_{OUT} + 500\text{mV})$ or $+2.5\text{V}$, whichever is greater; $\text{SHDN} = \text{IN}$, $C_{IN} = 1\mu\text{F}$, $C_{OUT} = 3.3\mu\text{F}$, $T_A = +25^\circ\text{C}$, unless otherwise noted.)

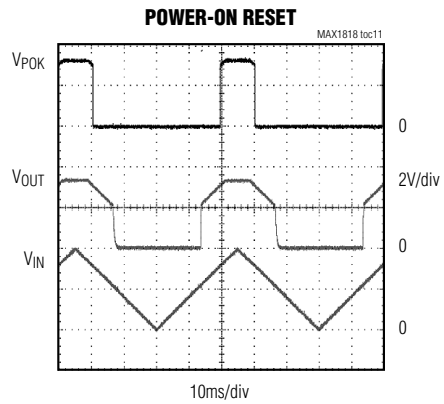
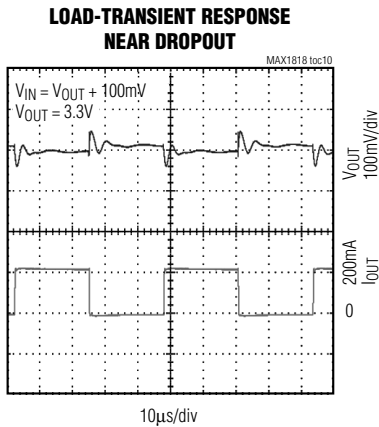
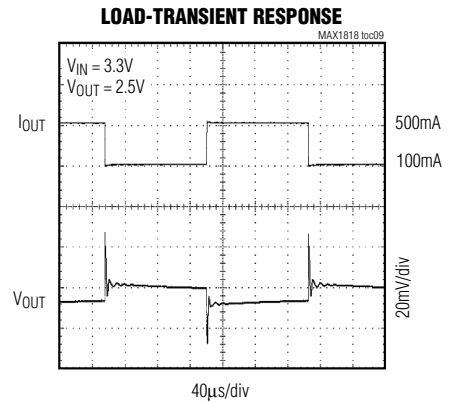
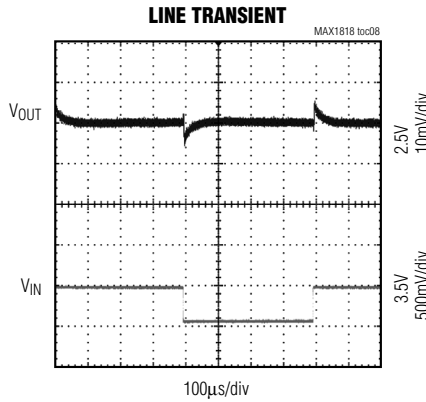
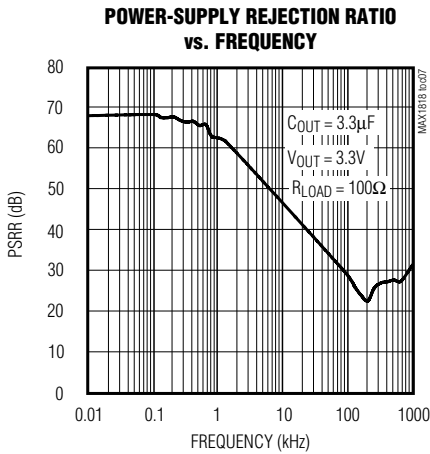
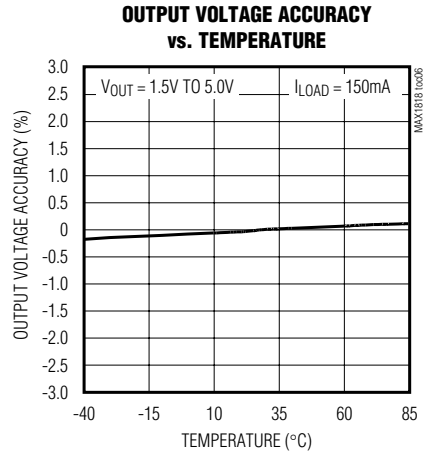
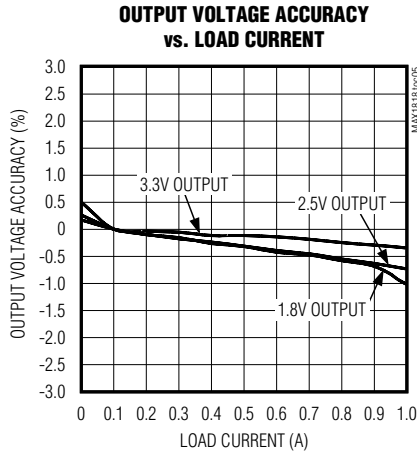
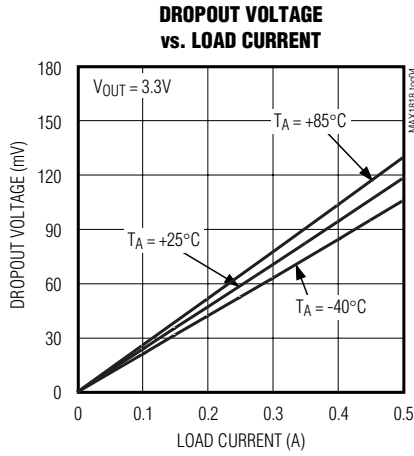

500mA Low-Dropout Linear Regulator in SOT23

MAX1818

Typical Operating Characteristics (continued)

($V_{IN} = (V_{OUT} + 500\text{mV})$ or $+2.5\text{V}$, whichever is greater; $\overline{\text{SHDN}} = \text{IN}$, $C_{IN} = 1\mu\text{F}$, $C_{OUT} = 3.3\mu\text{F}$, $T_A = +25^\circ\text{C}$, unless otherwise noted.)

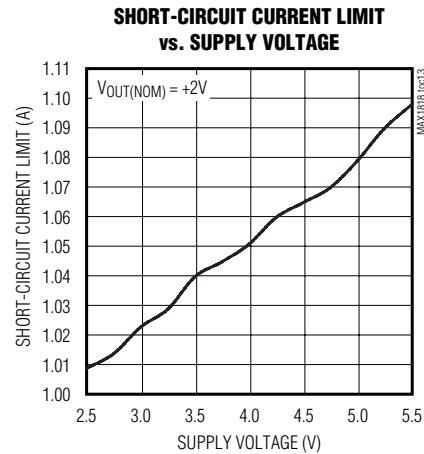
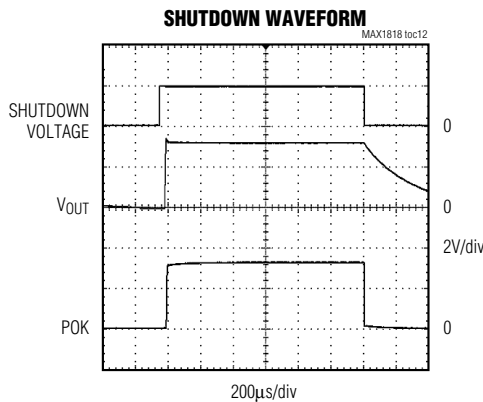

Pin Description

| PIN | NAME | FUNCTION |
|-----|--------------------------|---|
| 1 | IN | Regulator Input. Supply voltage can range from 2.5V to 5.5V. Bypass with a 1µF capacitor to GND (see <i>Capacitor Selection and Regulator Stability</i>). |
| 2 | POK | Open-Drain POK Output. POK remains low while the output voltage (V_{OUT}) is below the POK threshold. Connect a 100kΩ pull-up resistor from POK to OUT to obtain an output voltage. |
| 3 | $\overline{\text{SHDN}}$ | Active-Low Shutdown Input. A logic low reduces supply current below 15µA. In shutdown, the POK output is low, and OUT is high impedance. Connect to IN for normal operation. |
| 4 | GND | Ground |
| 5 | SET | Voltage-Setting Input. Connect to GND for preset output. Connect to a resistive voltage-divider between OUT and GND to set the output voltage between 1.25V and 5.0V. |
| 6 | OUT | Regulator Output. Sources up to 500mA. Bypass with a 3.3µF low-ESR capacitor to GND. Use a 4.7µF capacitor for output voltages below 2V. |

Detailed Description

The MAX1818 is a low-dropout, low-quiescent-current linear regulator designed primarily for battery-powered applications. The device supplies loads up to 500mA and is available with preset output voltages. As illustrated in Figure 1, the MAX1818 consists of a 1.25V reference, error amplifier, P-channel pass transistor, and internal feedback voltage-divider.

The 1.25V reference is connected to the error amplifier, which compares this reference with the feedback voltage and amplifies the difference. If the feedback voltage is lower than the reference voltage, the

pass-transistor gate is pulled lower, which allows more current to pass to the output and increases the output voltage. If the feedback voltage is too high, the pass-transistor gate is pulled up, allowing less current to pass to the output.

The output voltage is fed back through either an internal resistive divider connected to OUT or an external resistor network connected to SET. The Dual Mode comparator examines V_{SET} and selects the feedback path. If V_{SET} is below 50mV, the internal feedback path is used and the output is regulated to the factory-preset voltage.

500mA Low-Dropout Linear Regulator in SOT23

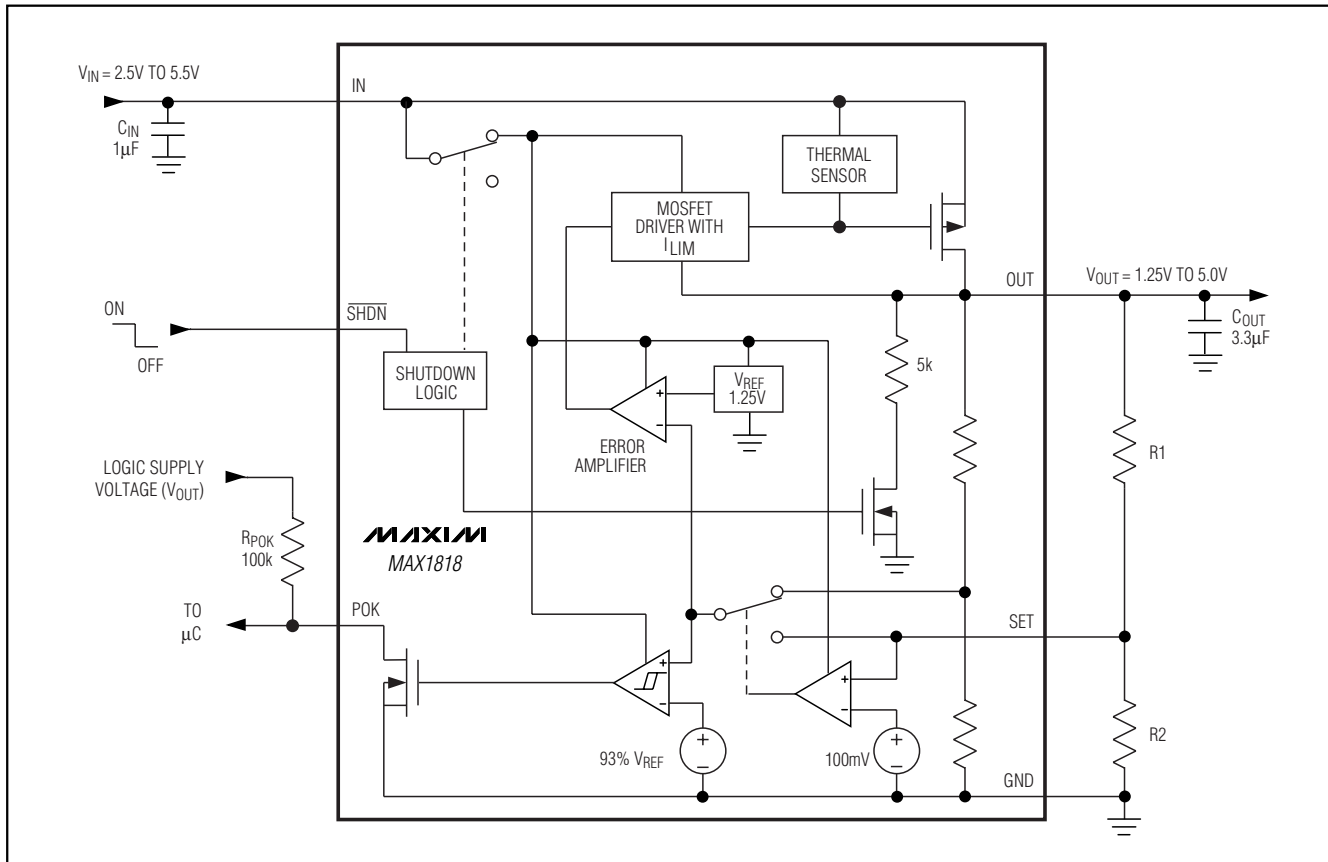

Figure 1. Functional Diagram

Additional blocks include an output current limiter, thermal sensor, and shutdown logic.

Internal P-Channel Pass Transistor

The MAX1818 features a 0.25Ω P-channel MOSFET pass transistor. Unlike similar designs using PNP pass transistors, P-channel MOSFETs require no base drive, which reduces quiescent current. PNP-based regulators also waste considerable current in dropout when the pass transistor saturates, and use high base-drive currents under large loads. The MAX1818 does not suffer from these problems and consumes only $125\mu\text{A}$ of quiescent current under heavy loads as well as in dropout.

Output Voltage Selection

The MAX1818's Dual Mode operation allows operation in either a preset voltage mode or an adjustable mode. Connect SET to GND to select the preset output voltage. The two-digit part number suffix identifies the out-

put voltage (see *Selector Guide*). For example, the MAX1818EUT33 has a preset 3.3V output voltage.

The output voltage may also be adjusted by connecting a voltage-divider from OUT to SET to GND (Figure 2). Select R2 in the $25\text{k}\Omega$ to $100\text{k}\Omega$ range. Calculate R1 with the following equation:

$$R1 = R2 [(V_{OUT} / V_{SET}) - 1]$$

where $V_{SET} = 1.25\text{V}$, and V_{OUT} may range from 1.25V to 5.0V.

Shutdown

Pull $\overline{\text{SHDN}}$ low to enter shutdown. During shutdown, the output is disconnected from the input and supply current drops to $0.1\mu\text{A}$. When in shutdown, POK pulls low and OUT is high impedance. The capacitance and load at OUT determine the rate at which V_{OUT} decays. $\overline{\text{SHDN}}$ can be pulled as high as 6V, regardless of the input and output voltage.

500mA Low-Dropout Linear Regulator in SOT23

MAX1818

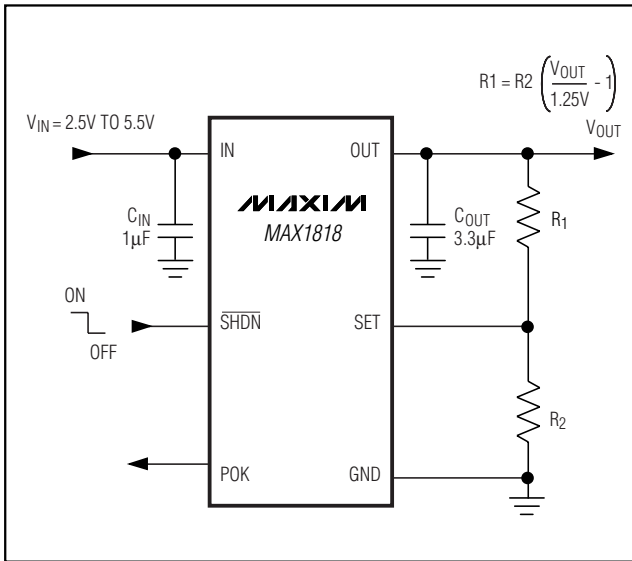

Figure 2. Adjustable Output Using External Feedback Resistors

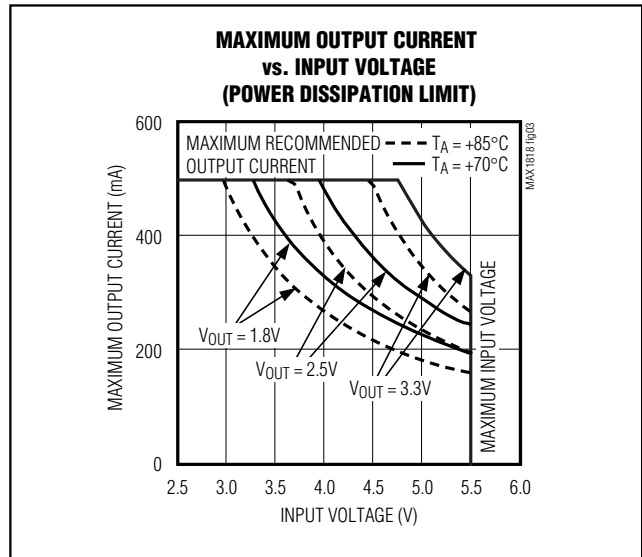

Figure 3. Power Operating Regions: Maximum Output vs. Supply Voltage

POK Output

The power OK (POK) output pulls low when OUT is less than 93% of the nominal regulation voltage. Once OUT exceeds 93% of the nominal voltage, POK goes high impedance. POK is an open-drain N-channel output. To obtain a voltage output, connect a pullup resistor from POK to OUT. A 100kΩ resistor works well for most applications. POK can be used as a power-okay (POK) signal to a microcontroller (µC), or drive an external LED to indicate power failure. When the MAX1818 is shut down, POK is held low independent of the output voltage. If unused, leave POK grounded or unconnected.

Current Limit

The MAX1818 monitors and controls the pass transistor's gate voltage, limiting the output current to 0.8A (typ). This current limit doubles when the output voltage is within 4% of the nominal value to improve performance with large load transients.

Thermal Overload Protection

Thermal overload protection limits total power dissipation in the MAX1818. When the junction temperature exceeds $T_J = +170^\circ\text{C}$, a thermal sensor turns off the pass transistor, allowing the IC to cool. The thermal sensor turns the pass transistor on again after the junction temperature cools by 20°C , resulting in a pulsed output during continuous thermal overload conditions. Thermal overload protection protects the MAX1818 in

the event of fault conditions. For continuous operation, do not exceed the absolute maximum junction-temperature rating of $T_J = +150^\circ\text{C}$.

Operating Region and Power Dissipation

The MAX1818's maximum power dissipation depends on the thermal resistance of the IC package and circuit board, the temperature difference between the die junction and ambient air, and the rate of air flow. The power dissipated in the device is $P = I_{OUT} \times (V_{IN} - V_{OUT})$. The maximum allowed power dissipation is 800mW at $T_A = +70^\circ\text{C}$ or:

$$P_{MAX} = (T_{J(MAX)} - T_A) / (\theta_{JC} + \theta_{CA})$$

where $T_J - T_A$ is the temperature difference between the MAX1818 die junction and the surrounding air, θ_{JC} is the thermal resistance of the junction to the case, and θ_{CA} is the thermal resistance from the case through the PC board, copper traces, and other materials to the surrounding air. For best heatsinking, the copper area should be equally shared between the IN, OUT, and GND pins.

The MAX1818 delivers up to 0.5A RMS and operates with input voltages up to +5.5V, but not simultaneously. High output currents can only be sustained when input-output differential voltages are low, as shown in Figure 3.

500mA Low-Dropout Linear Regulator in SOT23

Applications Information

Capacitor Selection and Regulator Stability

Capacitors are required at the MAX1818's input and output for stable operation over the full temperature range and with load currents up to 500mA. Connect a 1 μ F capacitor between IN and ground and a 3.3 μ F low-ESR capacitor between OUT and ground. For output voltages less than 2V, use a 4.7 μ F low-ESR output capacitor. The input capacitor (C_{IN}) lowers the source impedance of the input supply. Reduce noise and improve load-transient response, stability, and power-supply rejection by using larger output capacitors, such as 10 μ F.

The output capacitor's (C_{OUT}) equivalent series resistance (ESR) affects stability and output noise. Use output capacitors with an ESR of 0.1 Ω or less to ensure stability and optimum transient response. Surface-mount ceramic capacitors have very low ESR and are commonly available in values up to 10 μ F. Connect C_{IN} and C_{OUT} as close to the MAX1818 as possible to minimize the impact of PC board trace inductance.

Noise, PSRR, and Transient Response

The MAX1818 is designed to operate with low dropout voltages and low quiescent currents in battery-powered systems while still maintaining good noise, transient response, and AC rejection. See the *Typical Operating Characteristics* for a plot of power-supply rejection ratio (PSRR) versus frequency. When operating from noisy sources, improved supply-noise rejection and transient response can be achieved by increasing the values of

the input and output bypass capacitors and through passive filtering techniques.

The MAX1818 load-transient response (see *Typical Operating Characteristics*) shows two components of the output response: a DC shift from the output impedance due to the load current change, and the transient response. A typical transient response for a step change in the load current from 100mA to 500mA is 8mV. Increasing the output capacitor's value and decreasing the ESR attenuates the overshoot.

Input-Output (Dropout) Voltage

A regulator's minimum input-to-output voltage differential (dropout voltage) determines the lowest usable supply voltage. In battery-powered systems, this determines the useful end-of-life battery voltage. Because the MAX1818 uses a P-channel MOSFET pass transistor, its dropout voltage is a function of drain-to-source on-resistance ($R_{DS(ON)}$) multiplied by the load current (see *Typical Operating Characteristics*).

$$V_{DROPOUT} = V_{IN} - V_{OUT} = R_{DS(ON)} \times I_{OUT}$$

The MAX1818 ground current remains below 150 μ A in dropout.

Chip Information

TRANSISTOR COUNT: 845

500mA Low-Dropout Linear Regulator in SOT23

Package Information

MAX1818

SEE NOTE 5
EXAMPLE
TOP MARK

PIN 1
I.D. DOT
(SEE NOTE 6)

PIN #1

0.20
DATUM 'A'

| SYMBOL | MIN | MAX |
|--------|----------|------|
| A | 0.90 | 1.45 |
| A1 | 0.00 | 0.15 |
| A2 | 0.90 | 1.30 |
| b | 0.35 | 0.50 |
| C | 0.08 | 0.20 |
| D | 2.80 | 3.00 |
| E | 2.60 | 3.00 |
| E1 | 1.50 | 1.75 |
| L | 0.35 | 0.55 |
| e | 0.95 REF | |
| α | 0° | 10° |

NOTES:
 1. ALL DIMENSIONS ARE IN MILLIMETERS.
 2. FOOT LENGTH MEASURED AT INTERCEPT POINT BETWEEN DATUM A & LEAD SURFACE.
 3. PACKAGE OUTLINE EXCLUSIVE OF MOLD FLASH & METAL BURR.
 4. PACKAGE OUTLINE INCLUSIVE OF SOLDER PLATING.
 5. PIN 1 IS LOWER LEFT PIN WHEN READING TOP MARK FROM LEFT TO RIGHT. (SEE EXAMPLE TOP MARK)
 6. PIN 1 I.D. DOT IS 0.3 MM Ø MIN. LOCATED ABOVE PIN 1.
 7. MEETS JEDEC MO178.

6LSOT23

MAXIM
 PROPRIETARY INFORMATION
 TITLE:
 PACKAGE OUTLINE, SOT-23, 6L
 APPROVAL: _____ DOCUMENT CONTROL NO. 21-0058 REV E 1/1

Maxim cannot assume responsibility for use of any circuitry other than circuitry entirely embodied in a Maxim product. No circuit patent licenses are implied. Maxim reserves the right to change the circuitry and specifications without notice at any time.

Maxim Integrated Products, 120 San Gabriel Drive, Sunnyvale, CA 94086 408-737-7600 _____ 9