

USB1T11A

Universal Serial Bus Transceiver

General Description

The USB1T11A is a one chip generic USB transceiver. It is designed to allow 5.0V or 3.3V programmable and standard logic to interface with the physical layer of the Universal Serial Bus. It is capable of transmitting and receiving serial data at both full speed (12Mbit/s) and low speed (1.5Mbit/s) data rates.

The input and output signals of the USB1T11A conform with the "Serial Interface Engine". Implementation of the Serial Interface Engine along with the USB1T11A allows the designer to make USB compatible devices with off-the-shelf logic and easily modify and update the application.

Features

- Complies with Universal Serial Bus specification 1.1
- Utilizes digital inputs and outputs to transmit and receive USB cable data
- Supports 12Mbit/s "Full Speed" and 1.5Mbit/s "Low Speed" serial data transmission
- Compatible with the VHDL "Serial Interface Engine" from USB Implementers' Forum
- Supports single-ended data interface
- Single 3.3V supply
- ESD Performance : Human Body Model > 4000 V

Ordering Code:

Order Number	Package Number	Package Description
USB1T11AM	M14A	14-Lead Small Outline Integrated Circuit (SOIC), JEDEC MS-012, 0.150" Narrow
USB1T11AMTC	MTC14	14-Lead Thin Shrink Small Outline Package (TSSOP), JEDEC MO-153, 4.4mm Wide

Device also available in Tape and Reel. Specify by appending suffix letter "X" to the ordering code.

Connection Diagram

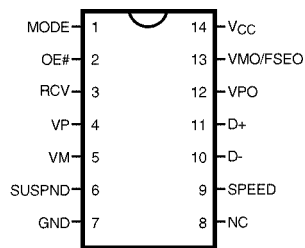

Logic Diagram

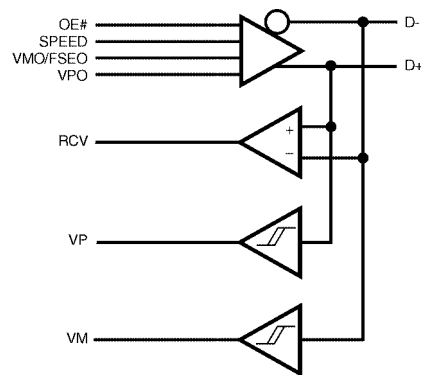

Pin Descriptions

Pin Name	I/O	Description																																				
RCV	O	Receive data. CMOS level output for USB differential input																																				
OE#	I	Output Enable. Active LOW, enables the transceiver to transmit data on the bus. When not active the transceiver is in receive mode.																																				
MODE	I	Mode. When left unconnected, a weak pull-up transistor pulls it to V _{CC} and in this GND, the V _{MO} /FSEO pin takes the function of FSEO (Force SEO).																																				
V _{PO} , V _{MO} /FSEO	I	Inputs to differential driver. (Outputs from SIE).																																				
		<table border="1"> <thead> <tr> <th>MODE</th> <th>VPO</th> <th>VMO/FSEO</th> <th>RESULT</th> </tr> </thead> <tbody> <tr> <td>0</td> <td>0</td> <td>0</td> <td>Logic "0"</td> </tr> <tr> <td></td> <td>0</td> <td>1</td> <td>SEO#</td> </tr> <tr> <td></td> <td>1</td> <td>0</td> <td>Logic "1"</td> </tr> <tr> <td></td> <td>1</td> <td>1</td> <td>SEO#</td> </tr> <tr> <td>1</td> <td>0</td> <td>0</td> <td>SEO#</td> </tr> <tr> <td></td> <td>0</td> <td>1</td> <td>Logic "0"</td> </tr> <tr> <td></td> <td>1</td> <td>0</td> <td>Logic "1"</td> </tr> <tr> <td></td> <td>1</td> <td>1</td> <td>Illegal code</td> </tr> </tbody> </table>	MODE	VPO	VMO/FSEO	RESULT	0	0	0	Logic "0"		0	1	SEO#		1	0	Logic "1"		1	1	SEO#	1	0	0	SEO#		0	1	Logic "0"		1	0	Logic "1"		1	1	Illegal code
		MODE	VPO	VMO/FSEO	RESULT																																	
		0	0	0	Logic "0"																																	
			0	1	SEO#																																	
			1	0	Logic "1"																																	
			1	1	SEO#																																	
1	0	0	SEO#																																			
	0	1	Logic "0"																																			
	1	0	Logic "1"																																			
	1	1	Illegal code																																			
V _P , V _M	O	Gated version of D- and D+. Outputs are logic "0" and logic "1". Used to detect single ended zero (SEO#), error conditions, and interconnect speed. (Input to SIE).																																				
		<table border="1"> <thead> <tr> <th>VP</th> <th>VM</th> <th>RESULT</th> </tr> </thead> <tbody> <tr> <td>0</td> <td>0</td> <td>SEO#</td> </tr> <tr> <td>0</td> <td>1</td> <td>Low Speed</td> </tr> <tr> <td>1</td> <td>0</td> <td>Full Speed</td> </tr> <tr> <td>1</td> <td>1</td> <td>Error</td> </tr> </tbody> </table>	VP	VM	RESULT	0	0	SEO#	0	1	Low Speed	1	0	Full Speed	1	1	Error																					
		VP	VM	RESULT																																		
		0	0	SEO#																																		
		0	1	Low Speed																																		
1	0	Full Speed																																				
1	1	Error																																				
D+, D-	AI/O	Data+, Data-. Differential data bus conforming to the Universal Serial Bus standard.																																				
SUSPND	I	Suspend. Enables a low power state while the USB bus is inactive. While the suspend pin is active it will drive the RCV pin to a logic "0" state. Both D+ and D- are 3-STATE.																																				
SPEED	I	Edge rate control. Logic "1" operates at edge rates for "full speed". Logic "0" operates edge rates for "low speed".																																				
V _{CC}		3.0V to 3.6V power supply																																				
GND		Ground reference																																				

Functional Truth Table

Input					I/O		Outputs			
Mode	VPO	VMO/FSEO	OE	SUSPND	D+	D-	RCV	V _P	V _M	Result
0	0	0	0	0	0	1	0	0	1	Logic 0
0	0	1	0	0	0	0	U	0	0	SEO#
0	1	0	0	0	1	0	1	1	0	Logic 1
0	1	1	0	0	0	0	U	0	0	SEO#
1	0	0	0	0	0	0	U	0	0	SEO#
1	0	1	0	0	0	1	0	0	1	Logic 0
1	1	0	0	0	1	0	1	1	0	Logic 1
1	1	1	0	0	1	1	U	U	U	Illegal Code
X	X	X	1	0	Z	Z	U	U	U	D+/D- Hi-Z
X	X	X	1	1	Z	Z	U	U	U	D+/D- Hi-Z

X = Don't Care
Z = 3-STATE
U = Undefined State

Absolute Maximum Ratings ^(Note 1)		Recommended Operating Conditions	
DC Supply Voltage (V_{CC})	-0.5V to +7.0V	Supply Voltage V_{CC}	3.0V to 3.6V
DC Input Diode Current (I_{IK})		Input Voltage (V_I)	0V to 5.5V
$V_I < 0$	-50 mA	Input Range for AI/O ($V_{AI/O}$)	0V to V_{CC}
Input Voltage (V_I)		Output Voltage (V_O)	0V to V_{CC}
(Note 2)	-0.5V to +5.5V	Operating Ambient Temperature	
Input Voltage ($V_{I/O}$)	-0.5V to $V_{CC} + 0.5V$	in free air (T_{amb})	-40°C to +85°C
Output Diode Current (I_{OK})			
$V_O > V_{CC}$ or $V_O < 0$	±50 mA		
Output Voltage (V_O)			
(Note 2)	-0.5V to $V_{CC} + 0.5V$		
Output Source or Sink Current (I_O)			
VP, VM, RCV pins			
$V_O = 0$ to V_{CC}	±15 mA		
Output Source or Sink Current (I_O)			
D+/D- pins			
$V_O = 0$ to V_{CC}	±50 mA		
V_{CC} or GND Current (I_{CC} , I_{GND})	±100 mA		
Storage Temperature (T_{STO})	-60°C to +150°C		

Note 1: The Absolute Maximum Ratings are those values beyond which the safety of the device cannot be guaranteed. The device should not be operated at these limits. The parametric values defined in the Electrical Characteristic tables are not guaranteed at the absolute maximum rating. The "Recommended Operating Conditions" table will define the conditions for actual device operation.

Note 2: The input and output voltage ratings may be exceeded if the input and output clamp current ratings are observed.

DC Electrical Characteristics (Digital Pins)

Over recommended range of supply voltage and operating free air temperature (unless otherwise noted). $V_{CC} = 3.0V$ to $3.6V$

Symbol	Parameter	Test Conditions	Limits			Unit
			Temp = -40°C to +85°C			
			Min	Typ	Max	
INPUT LEVELS:						
V_{IL}	LOW Level Input Voltage				0.8	V
V_{IH}	HIGH Level Input Voltage		2.0			V
OUTPUT LEVELS:						
V_{OL}	LOW Level Output Voltage	$I_{OL} = 4$ mA			0.4	V
		$I_{OL} = 20$ μ A			0.1	
V_{OH}	HIGH Level Output Voltage	$I_{OH} = 4$ mA	2.4			V
		$I_{OH} = 20$ μ A	$V_{CC} - 0.1$			
LEAKAGE CURRENT:						
I_L	Input Leakage Current	$V_{CC} = 3.0$ to 3.6			±5	μ A
I_{CCFS}	Supply Current (Full Speed)	$V_{CC} = 3.0$ to 3.6			5	mA
I_{CCLS}	Supply Current (Low Speed)	$V_{CC} = 3.0$ to 3.6			5	mA
I_{CCQ}	Quiescent Current	$V_{CC} = 3.0$ to 3.6 $V_{IN} = V_{CC}$ or GND			5	mA
I_{CCS}	Supply Current in Suspend	$V_{CC} = 3.0$ to 3.6 ; Mode = V_{CC}			10	μ A

DC Electrical Characteristics (D+/D- Pins)Over recommended range of supply voltage and operating free air temperature (unless otherwise noted). $V_{CC} = 3.0V$ to $3.6V$

Symbol	Parameter	Test Conditions	Limits			Units
			Temp = -40°C to +85°C			
			Min	Typ	Max	
INPUT LEVELS:						
V_{DI}	Differential Input Sensitivity	$ (D+) - (D-) $	0.2			V
V_{CM}	Differential Common Mode Range	Includes V_{DI} Range	0.8		2.5	V
V_{SE}	Single Ended Receiver Threshold		0.8		2.0	V
OUTPUT LEVELS:						
V_{OL}	Static Output LOW Voltage	R_L of 1.5 k Ω to 3.6V			0.3	V
V_{OH}	Static Output HIGH Voltage	R_L of 15 k Ω to GND	2.8		3.6	V
V_{CR}	Differential Crossover		1.3		2.0	V
LEAKAGE CURRENT:						
I_{OZ}	High Z State Data Line Leakage Current	$0V < V_{IN} < 3.3V$			± 5	μA
CAPACITANCE:						
C_{IN} (Note 4)	Transceiver Capacitance	Pin to GND			10	pF
	Capacitance Match				10	%
OUTPUT RESISTANCE:						
Z_{DRV} (Note 3)	Driver Output Resistance	Steady State Drive	4		20	Ω
	Resistance Match				10	%

Note 3: Excludes external resistor. In order to comply with USB Specification 1.1, external series resistors of $24\Omega \pm 1\%$ each on D+ and D- are recommended. This specification is guaranteed by design and statistical process distribution.

Note 4: This specification is guaranteed by design and statistical process distribution.

AC Electrical Characteristics (D+/D- Pins, Full Speed)Over recommended range of supply voltage and operating free air temperature (unless otherwise noted). $V_{CC} = 3.0V$ to $3.6V$ $C_L = 50$ pF; $R_L = 1.5$ k Ω on D+ to V_{CC}

Symbol	Parameter	Test Condition	Limits			Units
			Temp = -40°C to +85°C			
			Min	Typ	Max	
DRIVER CHARACTERISTICS:						
t_R	Rise Time	10% and 90% Figure 1	4		20	ns
t_F	Fall Time	Figure 1	4		20	ns
t_{RFM}	Rise/Fall Time Matching	(t_r/t_f)	90		110	%
V_{CRS}	Output Signal Crossover Voltage		1.3		2.0	V
DRIVER TIMINGS:						
t_{PLH}	Driver Propagation Delay	Figure 2			18	ns
t_{PLH}	(VPO, VMO/FSEO to D+/D-)	Figure 2			18	ns
t_{PHZ}	Driver Disable Delay	Figure 4			13	ns
t_{PLZ}	(OE# to D+/D-)	Figure 4			13	ns
t_{PZH}	Driver Enable Delay	Figure 4			17	ns
t_{PZL}	(OE# to D+/D-)	Figure 4			17	ns
RECEIVER TIMINGS:						
t_{PLH}	Receiver Propagation Delay	Figure 3			16	ns
t_{PHL}	(D+, D- to RCV)	Figure 3			19	ns
t_{PLH}	Single-ended Receiver Delay	Figure 3			8	ns
t_{PHL}	(D+, D- to VP, VM)	Figure 3			8	ns

AC Electrical Characteristics (D+/D- Pins, Low Speed)						
Over recommended range of supply voltage and operating free air temperature (unless otherwise noted). $V_{CC} = 3.0V$ to $3.6V$ $C_L = 200$ to 600 pF; $R_L = 1.5k$ on D- to V_{CC}						
Symbol	Parameter	Test Conditions	Limits			Unit
			$T_{amb} = -40^{\circ}C$ to $+85^{\circ}C$			
			Min	Typ	Max	
DRIVER CHARACTERISTICS:						
t_{LR}	Rise Time	10% and 90% Figure 1	75		300	ns
t_{LF}	Fall Time	Figure 1	75		300	
t_{RFM}	Rise/Fall Time Matching	(t_r/t_f)	80		120	%
V_{CRS}	Output Signal Crossover Voltage		1.3		2.0	V
DRIVER TIMINGS:						
t_{PLH}	Driver Propagation Delay	Figure 2			300	ns
t_{PHL}	(VPO, VMO/FSEO to D+/D-)	Figure 2			300	ns
t_{PHZ}	Driver Disable Delay	Figure 4			13	ns
t_{PLZ}	(OE# to D+/D-)	Figure 4			13	ns
t_{PZH}	Driver Enable Delay	Figure 4			205	ns
t_{PZL}	(OE# to D+/D-)	Figure 4			205	ns
RECEIVER TIMINGS:						
t_{PLH}	Receiver Propagation Delay	Figure 3			18	ns
t_{PHL}	(D+, D- to RCV)	Figure 3			18	ns
t_{PLH}	Single-ended Receiver Delay	Figure 3			28	ns
t_{PHL}	(D+, D- to VP, VM)	Figure 3			28	ns

AC Waveforms

V_{OL} and V_{OH} are the typical output voltage drops that occur with the output load. (V_{CC} never goes below 3.0V)

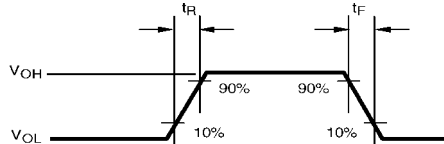

FIGURE 1. Rise and Fall Times

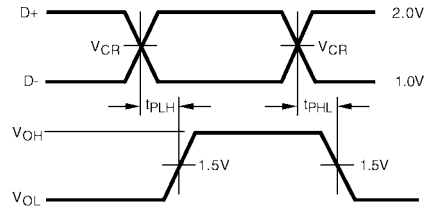

FIGURE 2. VPI, VMO/FSE0 to D+/D-

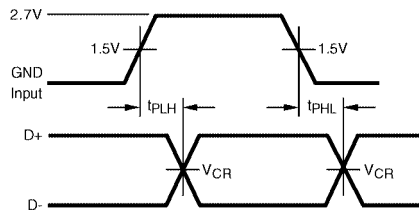

FIGURE 3. D+/D- to RCV, VP/VM

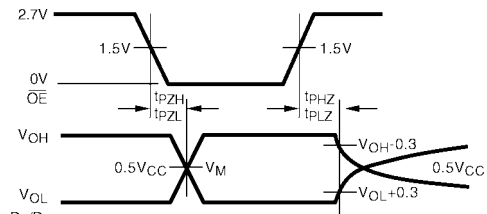
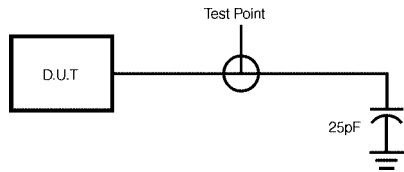
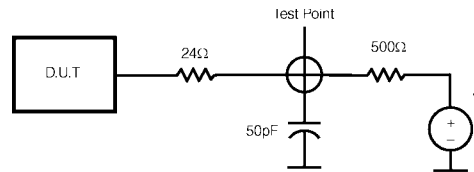

FIGURE 4. OE# to D+/D-

Test Circuits and Waveforms



Load for VM/VP and RCV



Load for Enable and Disable Times

Note:

$V = 0$ for t_{PZH} , t_{PHZ}

$V = V_{CC}$ for t_{PZL} , t_{PLZ}

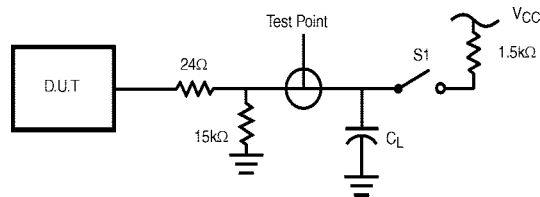

Load for D+/D-

$C_L = 50$ pF, Full Speed

$C_L = 50$ pFm Low Speed (Min Timing)

$C_L = 350$ pF, Low Speed (Max Timing)

1.5 kΩ on D- (Low Speed) or D+ (Full Speed) only

Test	S1
D-/LS	Close
D+/LS	Open
D-/FS	Open
D+/FS	Close

Physical Dimensions inches (millimeters) unless otherwise noted

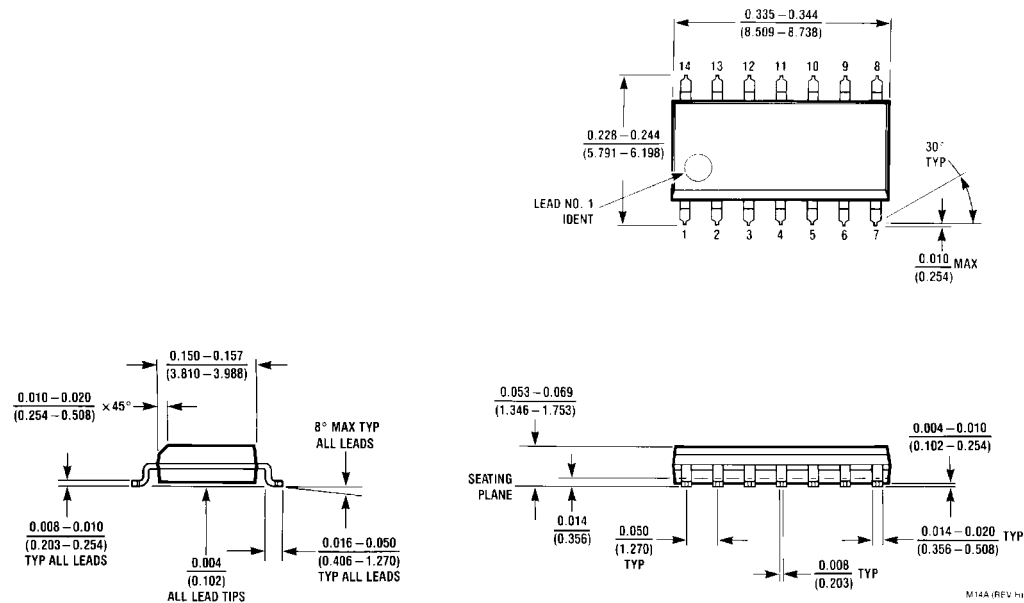

14-Lead Small Outline Integrated Circuit (SOIC), JEDEC MS-012, 0.150" Narrow Package Number M14A

Physical Dimensions inches (millimeters) unless otherwise noted (Continued)

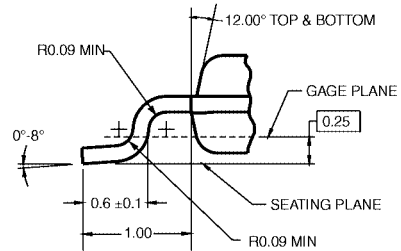
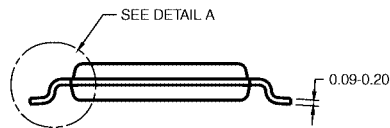
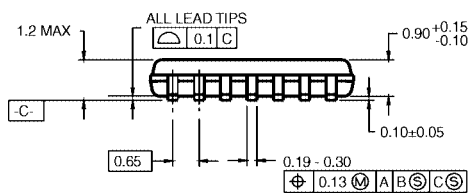
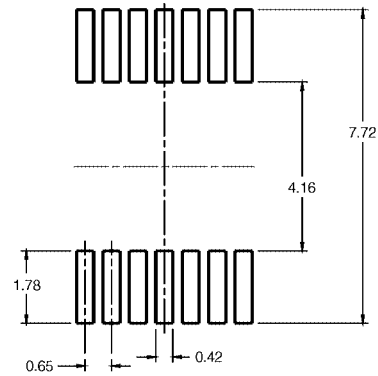
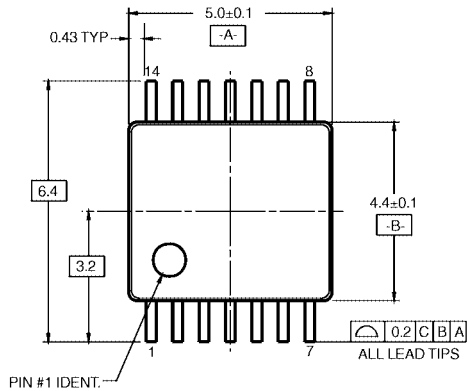

- NOTES:
- CONFORMS TO JEDEC REGISTRATION MO-153, VARIATION AB, REF NOTE 6, DATE 7/93.
 - DIMENSIONS ARE IN MILLIMETERS.
 - DIMENSIONS ARE EXCLUSIVE OF BURRS, MOLD FLASH, AND TIE BAR EXTRUSIONS.
 - DIMENSIONS AND TOLERANCES PER ANSI Y14.5M, 1982.

MTC14RevC3

DETAIL A

14-Lead Thin Shrink Small Outline Package (TSSOP), JEDEC MO-153, 4.4mm Wide Package Number MTC14

Fairchild does not assume any responsibility for use of any circuitry described, no circuit patent licenses are implied and Fairchild reserves the right at any time without notice to change said circuitry and specifications.

LIFE SUPPORT POLICY

FAIRCHILD'S PRODUCTS ARE NOT AUTHORIZED FOR USE AS CRITICAL COMPONENTS IN LIFE SUPPORT DEVICES OR SYSTEMS WITHOUT THE EXPRESS WRITTEN APPROVAL OF THE PRESIDENT OF FAIRCHILD SEMICONDUCTOR CORPORATION. As used herein:

- Life support devices or systems are devices or systems which, (a) are intended for surgical implant into the body, or (b) support or sustain life, and (c) whose failure to perform when properly used in accordance with instructions for use provided in the labeling, can be reasonably expected to result in a significant injury to the user.
- A critical component in any component of a life support device or system whose failure to perform can be reasonably expected to cause the failure of the life support device or system, or to affect its safety or effectiveness.

www.fairchildsemi.com