

LM2930 3-Terminal Positive Regulator

General Description

The LM2930 3-terminal positive regulator features an ability to source 150 mA of output current with an input-output differential of 0.6V or less. Efficient use of low input voltages obtained, for example, from an automotive battery during cold crank conditions, allows 5V circuitry to be properly powered with supply voltages as low as 5.6V. Familiar regulator features such as current limit and thermal overload protection are also provided.

Designed originally for automotive applications, the LM2930 and all regulated circuitry are protected from reverse battery installations or 2 battery jumps. During line transients, such as a load dump (40V) when the input voltage to the regulator can momentarily exceed the specified maximum operating voltage, the regulator will automatically shut down to protect both internal circuits and the load. The LM2930 cannot be harmed by temporary mirror-image insertion.

Fixed outputs of 5V and 8V are available in the plastic TO-220 and TO-263 power packages.

Features

- Input-output differential less than 0.6V
- Output current in excess of 150 mA
- Reverse battery protection
- 40V load dump protection
- Internal short circuit current limit
- Internal thermal overload protection
- Mirror-image insertion protection
- P+ Product Enhancement tested

Voltage Range

LM2930T-5.0:	5V
LM2930T-8.0:	8V
LM2930S-5.0:	5V
LM2930S-8.0:	8V

Connection Diagrams

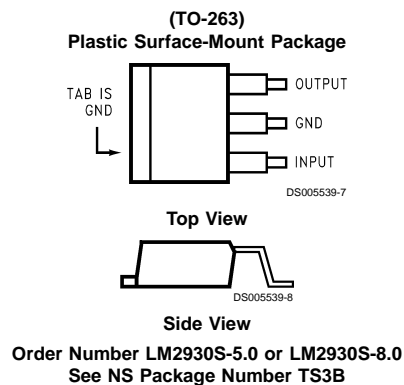
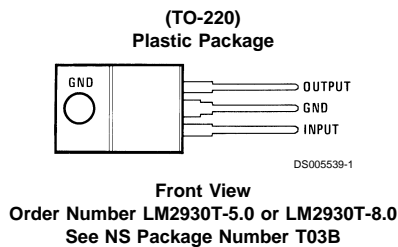

Absolute Maximum Ratings (Note 1)

If Military/Aerospace specified devices are required, please contact the National Semiconductor Sales Office/Distributors for availability and specifications.

Input Voltage

Operating Range 26V
Overvoltage Protection 40V

Reverse Voltage (100 ms)

-12V

Reverse Voltage (DC)

-6V

Internal Power Dissipation (Note 2)

Internally Limited

Operating Temperature Range

-40°C to +85°C

Maximum Junction Temperature

125°C

Storage Temperature Range

-65°C to +150°C

Lead Temp. (Soldering, 10 seconds)

230°C

Electrical Characteristics (Note 3)LM2930-5.0 $V_{IN}=14V$, $I_O=150\text{ mA}$, $T_J=25^\circ\text{C}$ (Note 6), $C_2=10\ \mu\text{F}$, unless otherwise specified

Parameter	Conditions	Typ	Tested Limit (Note 4)	Design Limit (Note 5)	Unit
Output Voltage		5	5.3 4.7		V_{MAX} V_{MIN}
	$6V \leq V_{IN} \leq 26V$, $5\text{ mA} \leq I_O \leq 150\text{ mA}$ $-40^\circ\text{C} \leq T_J \leq 125^\circ\text{C}$			5.5 4.5	V_{MAX} V_{MIN}
Line Regulation	$9V \leq V_{IN} \leq 16V$, $I_O=5\text{ mA}$	7	25		mV_{MAX}
	$6V \leq V_{IN} \leq 26V$, $I_O=5\text{ mA}$	30	80		mV_{MAX}
Load Regulation	$5\text{ mA} \leq I_O \leq 150\text{ mA}$	14	50		mV_{MAX}
Output Impedance	100 mA_{DC} & 10 mA_{rms} , 100 Hz–10 kHz	200			$\text{m}\Omega$
Quiescent Current	$I_O=10\text{ mA}$	4	7		mA_{MAX}
	$I_O=150\text{ mA}$	18	40		mA_{MAX}
Output Noise Voltage	10 Hz–100 kHz	140			μV_{rms}
Long Term Stability		20			$\text{mV}/1000\text{ hr}$
Ripple Rejection	$f_O=120\text{ Hz}$	56			dB
Current Limit		400	700 150		mA_{MAX} mA_{MIN}
Dropout Voltage	$I_O=150\text{ mA}$	0.32	0.6		V_{MAX}
Output Voltage Under Transient Conditions	$-12V \leq V_{IN} \leq 40V$, $R_L=100\Omega$		5.5 -0.3		V_{MAX} V_{MIN}

Electrical Characteristics (Note 3)LM2930-8.0 ($V_{IN}=14V$, $I_O=150\text{ mA}$, $T_J=25^\circ\text{C}$ (Note 6), $C_2=10\ \mu\text{F}$, unless otherwise specified)

Parameter	Conditions	Typ	Tested Limit (Note 4)	Design Limit (Note 5)	Unit
Output Voltage		8	8.5 7.5		V_{MAX} V_{MIN}
	$9.4V \leq V_{IN} \leq 26V$, $5\text{ mA} \leq I_O \leq 150\text{ mA}$, $-40^\circ\text{C} \leq T_J \leq 125^\circ\text{C}$			8.8 7.2	V_{MAX} V_{MIN}
Line Regulation	$9.4V \leq V_{IN} \leq 16V$, $I_O=5\text{ mA}$	12	50		mV_{MAX}
	$9.4V \leq V_{IN} \leq 26V$, $I_O=5\text{ mA}$	50	100		mV_{MAX}
Load Regulation	$5\text{ mA} \leq I_O \leq 150\text{ mA}$	25	50		mV_{MAX}
Output Impedance	100 mA_{DC} & 10 mA_{rms} , 100 Hz–10 kHz	300			$\text{m}\Omega$
Quiescent Current	$I_O=10\text{ mA}$	4	7		mA_{MAX}
	$I_O=150\text{ mA}$	18	40		mA_{MAX}
Output Noise Voltage	10 Hz–100 kHz	170			μV_{rms}
Long Term Stability		30			$\text{mV}/1000\text{ hr}$
Ripple Rejection	$f_O=120\text{ Hz}$	52			dB

Electrical Characteristics (Note 3) (Continued)

LM2930-8.0 ($V_{IN}=14V$, $I_O=150\text{ mA}$, $T_J=25^\circ\text{C}$ (Note 6), $C_2=10\ \mu\text{F}$, unless otherwise specified)

Parameter	Conditions	Typ	Tested Limit (Note 4)	Design Limit (Note 5)	Unit
Current Limit		400	700		mA_{MAX}
			150		mA_{MIN}
Dropout Voltage	$I_O=150\text{ mA}$	0.32	0.6		V_{MAX}
Output Voltage Under Transient Conditions	$-12V \leq V_{IN} \leq 40V$, $R_L=100\Omega$		8.8		V_{MAX}
			-0.3		V_{MIN}

Note 1: Absolute Maximum Ratings indicate limits beyond which damage to the device may occur. Operating ratings indicate conditions for which the device is functional, but do not guarantee specific performance limits. Electrical Characteristics state DC and AC electrical specifications under particular test conditions which guarantee specific performance limits. This assumes that the device is within the Operating Ratings. Specifications are not guaranteed for parameters where no limit is given, however, the typical value is a good indication of device performance.

Note 2: Thermal resistance without a heat sink for junction to case temperature is 3°C/W and for case to ambient temperature is 50°C/W for the TO-220, 73°C/W for the TO-263. If the TO-263 package is used, the thermal resistance can be reduced by increasing the P.C. board copper area thermally connected to the package. Using 0.5 square inches of copper area, θ_{JA} is 50°C/W ; with 1 square inch of copper area, θ_{JA} is 37°C/W ; and with 1.6 or more square inches of copper area, θ_{JA} is 32°C/W .

Note 3: All characteristics are measured with a capacitor across the input of $0.1\ \mu\text{F}$ and a capacitor across the output of $10\ \mu\text{F}$. All characteristics except noise voltage and ripple rejection ratio are measured using pulse techniques ($t_W \leq 10\text{ ms}$, duty cycles $\leq 5\%$). Output voltage changes due to changes in internal temperature must be taken into account separately.

Note 4: Guaranteed and 100% production tested.

Note 5: Guaranteed (but not 100% production tested) over the operating temperature and input current ranges. These limits are not used to calculate outgoing quality levels.

Note 6: To ensure constant junction temperature, low duty cycle pulse testing is used.

Typical Application

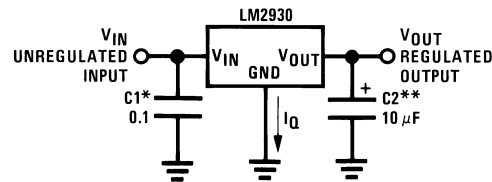

DS005539-5

*Required if regulator is located far from power supply filter.

** C_{OUT} must be at least $10\ \mu\text{F}$ to maintain stability. May be increased without bound to maintain regulation during transients. Locate as close as possible to the regulator. This capacitor must be rated over the same operating temperature range as the regulator. The equivalent series resistance (ESR) of this capacitor should be less than $1\ \Omega$ over the expected operating temperature range.

Typical Performance Characteristics

Output Impedance

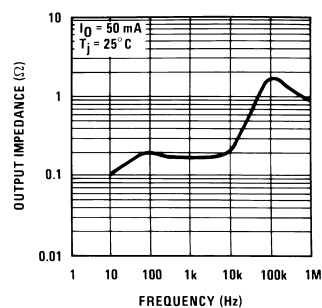

DS005539-11

Overvoltage Supply Current

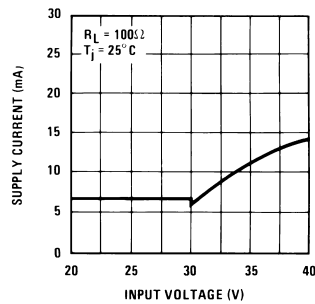

DS005539-12

Reverse Supply Current

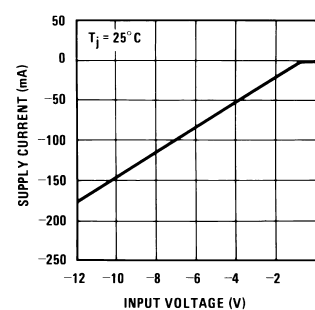

DS005539-13

Typical Performance Characteristics (Continued)

Output at Reverse Supply

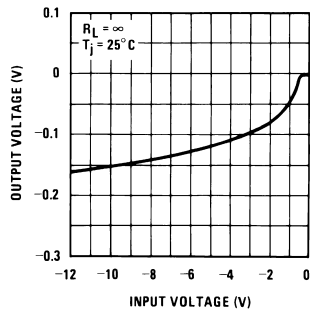

Output at Overvoltage

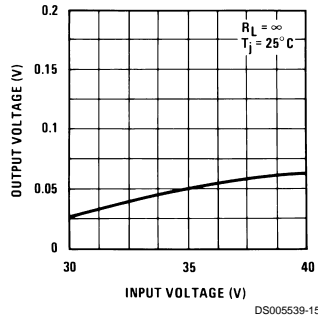

Output Voltage (Normalized to 1V at $T_j=25^\circ\text{C}$)

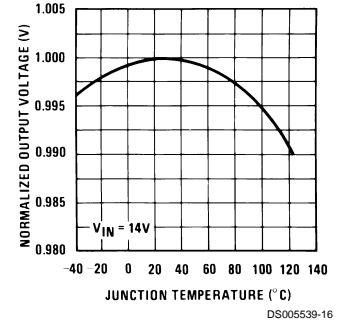

Dropout Voltage

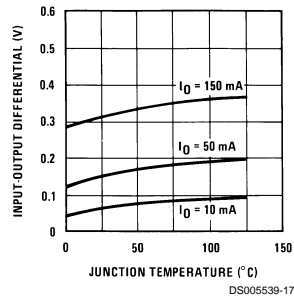

Dropout Voltage

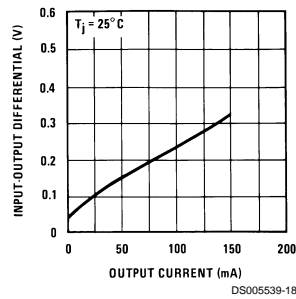

Low Voltage Behavior

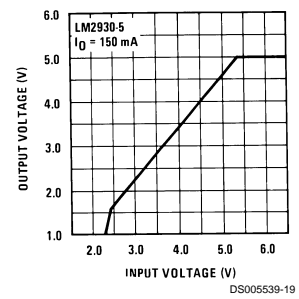

High Voltage Behavior

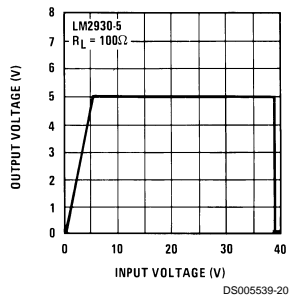

Line Transient Response

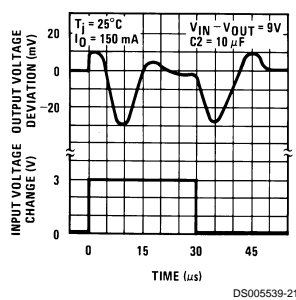

Load Transient Response

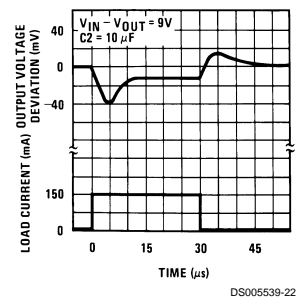

Typical Performance Characteristics (Continued)

Peak Output Current

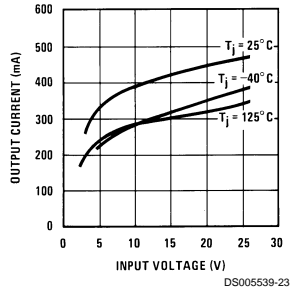

Quiescent Current

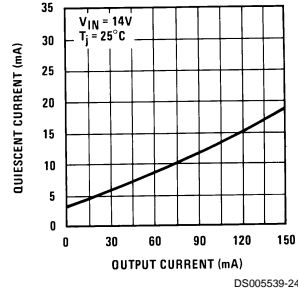

Quiescent Current

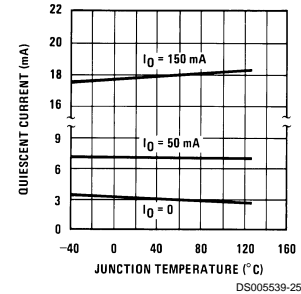

Quiescent Current

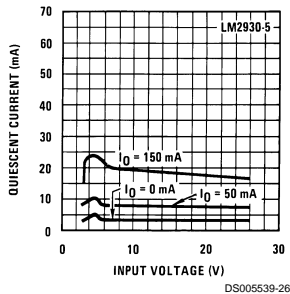

Ripple Rejection

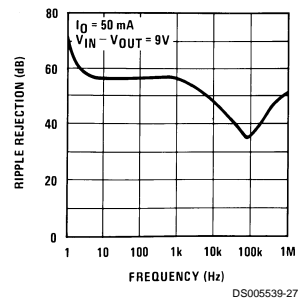

Ripple Rejection

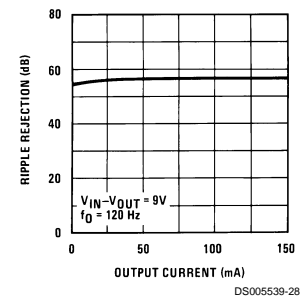

Definition of Terms

Dropout Voltage: The input-output voltage differential at which the circuit ceases to regulate against further reduction in input voltage. Measured when the output voltage has dropped 100 mV from the nominal value obtained at 14V input, dropout voltage is dependent upon load current and junction temperature.

Input Voltage: The DC voltage applied to the input terminals with respect to ground.

Input-Output Differential: The voltage difference between the unregulated input voltage and the regulated output voltage for which the regulator will operate.

Line Regulation: The change in output voltage for a change in the input voltage. The measurement is made under conditions of low dissipation or by using pulse techniques such that the average chip temperature is not significantly affected.

Load Regulation: The change in output voltage for a change in load current at constant chip temperature.

Long Term Stability: Output voltage stability under accelerated life-test conditions after 1000 hours with maximum rated voltage and junction temperature.

Output Noise Voltage: The rms AC voltage at the output, with constant load and no input ripple, measured over a specified frequency range.

Quiescent Current: That part of the positive input current that does not contribute to the positive load current. The regulator ground lead current.

Ripple Rejection: The ratio of the peak-to-peak input ripple voltage to the peak-to-peak output ripple voltage.

Temperature Stability of V_O : The percentage change in output voltage for a thermal variation from room temperature to either temperature extreme.

Maximum Power Dissipation (TO-220)

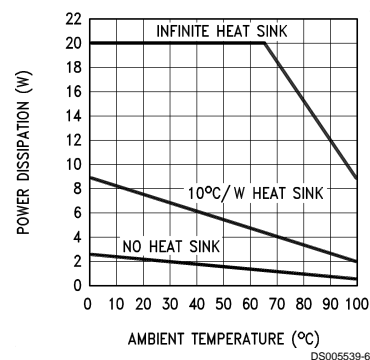

Definition of Terms (Continued)

**Maximum Power Dissipation
(TO-263) (Note 2)**

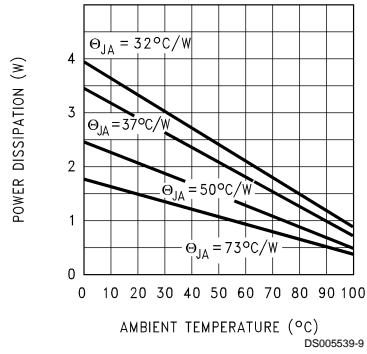

Schematic Diagram

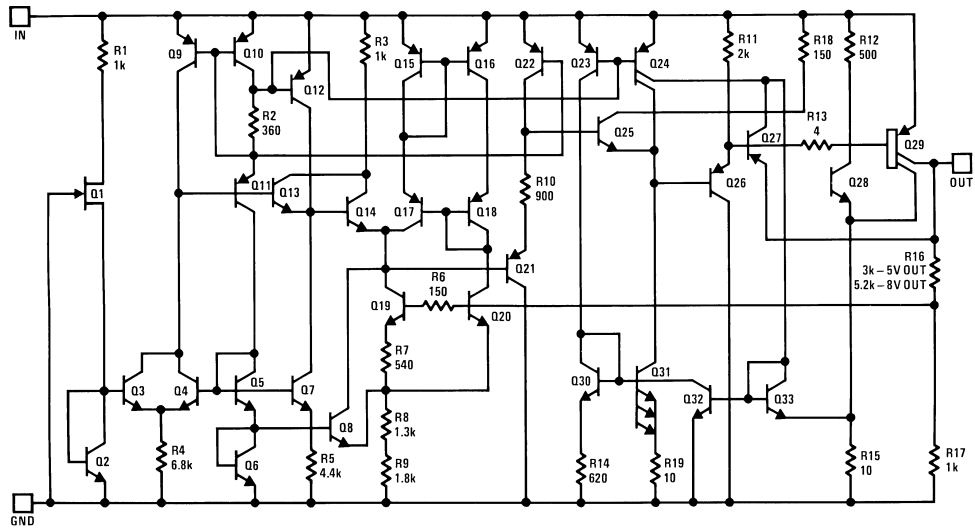

Physical Dimensions inches (millimeters) unless otherwise noted

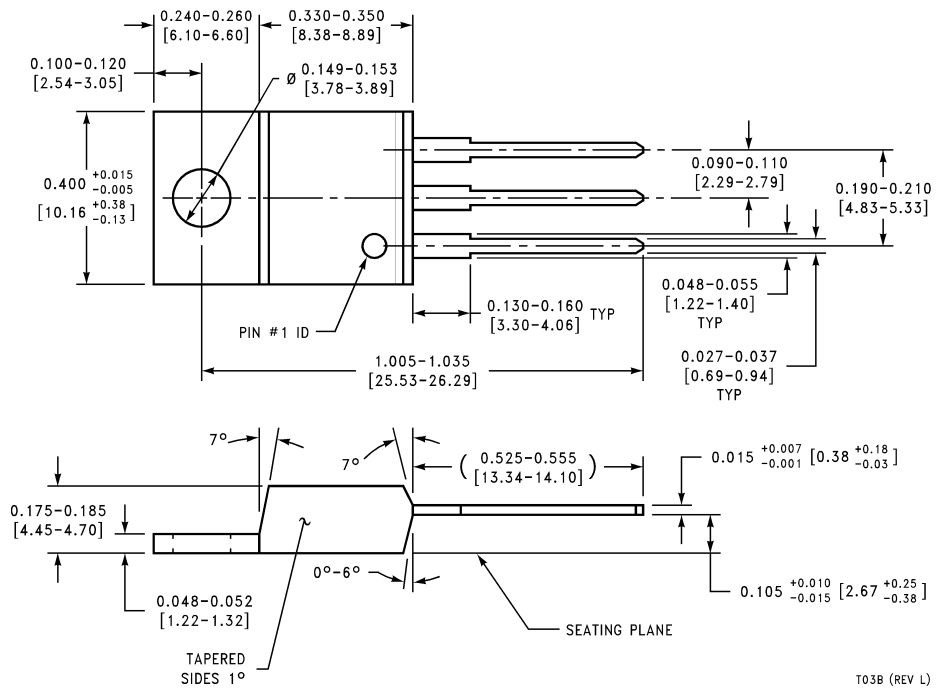

TO-220 3-Lead Molded Package
Order Number LM2930T-5.0 or LM2930T-8.0
NS Package Number T03B

T03B (REV L)

Physical Dimensions inches (millimeters) unless otherwise noted (Continued)

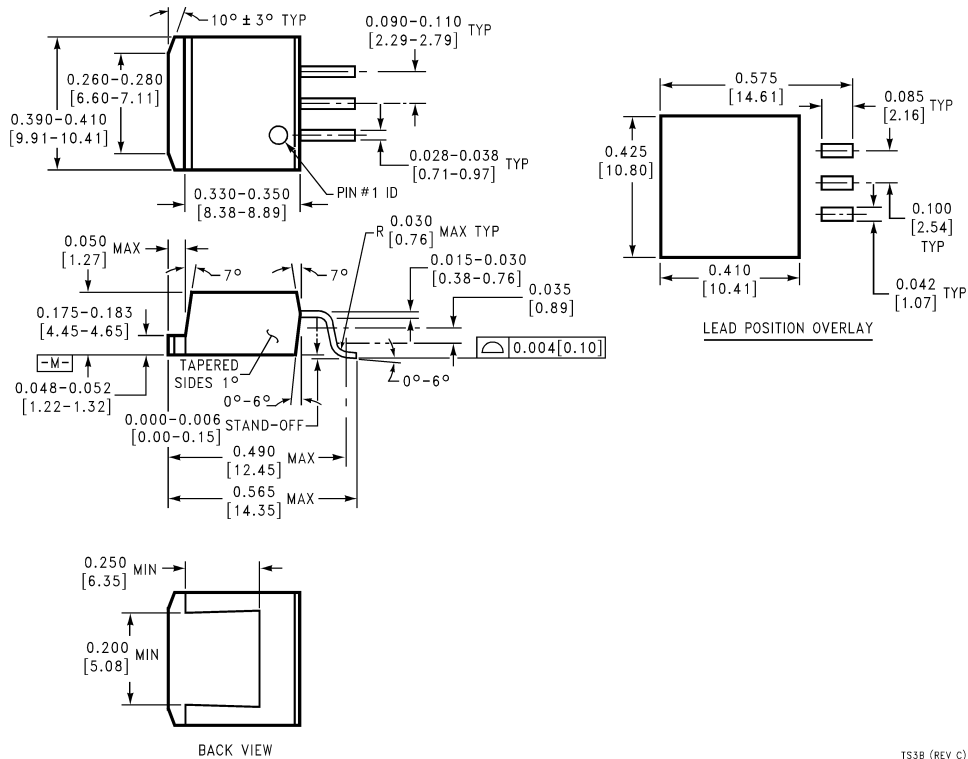

TO-263 3-Lead Plastic Surface Mount Package
Order Number LM2930S-5.0 or LM2930S-8.0
NS Package Number TS3B

TS3B (REV C)

LIFE SUPPORT POLICY

NATIONAL'S PRODUCTS ARE NOT AUTHORIZED FOR USE AS CRITICAL COMPONENTS IN LIFE SUPPORT DEVICES OR SYSTEMS WITHOUT THE EXPRESS WRITTEN APPROVAL OF THE PRESIDENT OF NATIONAL SEMICONDUCTOR CORPORATION. As used herein:

1. Life support devices or systems are devices or systems which, (a) are intended for surgical implant into the body, or (b) support or sustain life, and whose failure to perform when properly used in accordance with instructions for use provided in the labeling, can be reasonably expected to result in a significant injury to the user.
2. A critical component in any component of a life support device or system whose failure to perform can be reasonably expected to cause the failure of the life support device or system, or to affect its safety or effectiveness.



National Semiconductor Corporation
 Americas
 Tel: 1-800-272-9959
 Fax: 1-800-737-7018
 Email: support@nsc.com

National Semiconductor Europe
 Fax: +49 (0) 1 80-530 85 86
 Email: europe.support@nsc.com
 Deutsch Tel: +49 (0) 1 80-530 85 85
 English Tel: +49 (0) 1 80-532 78 32
 Français Tel: +49 (0) 1 80-532 93 58
 Italiano Tel: +49 (0) 1 80-534 16 80

National Semiconductor Asia Pacific Customer Response Group
 Tel: 65-2544466
 Fax: 65-2504466
 Email: sea.support@nsc.com

National Semiconductor Japan Ltd.
 Tel: 81-3-5620-6175
 Fax: 81-3-5620-6179

www.national.com

National does not assume any responsibility for use of any circuitry described, no circuit patent licenses are implied and National reserves the right at any time without notice to change said circuitry and specifications.