

SHINDENGEN

Schottky Rectifiers (SBD)

Dual

SF30SC6

60V 30A

FEATURES

- Tj150°C
- P_{RRSM} avalanche guaranteed
- Fully Isolated Molding
- Dielectric strength 2kV guaranteed

APPLICATION

- Switching power supply
- DC/DC converter
- Home Appliances, Office Equipment
- Telecommunication

OUTLINE DIMENSIONS

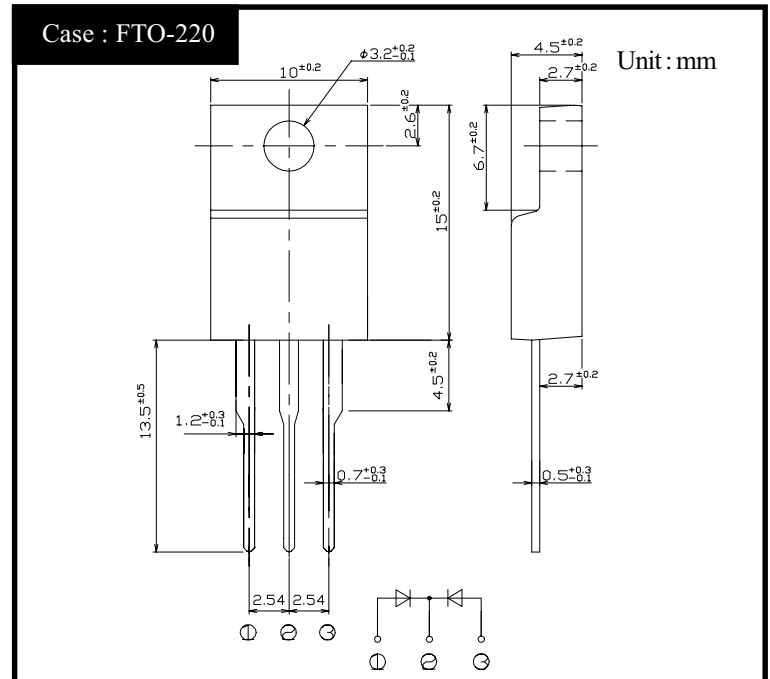

RATINGS

● Absolute Maximum Ratings (If not specified T_c=25°C)

Item	Symbol	Conditions	Ratings	Unit
Storage Temperature	T _{stg}		-55 ~ 150	°C
Operating Junction Temperature	T _j		150	°C
Maximum Reverse Voltage	V _{RM}		60	V
Repetitive Peak Surge Reverse Voltage	V _{RRSM}	Pulse width 0.5ms, duty 1/40	65	V
Average Rectified Forward Current	I _O	50Hz sine wave, R-load, Rating for each diode I _O /2, T _c =107°C	30	A
Peak Surge Forward Current	I _{FSM}	50Hz sine wave, Non-repetitive 1 cycle peak value, T _j =25°C	250	A
Repetitive Peak Surge Reverse Power	P _{RRSM}	Pulse width 10 μs, Rating of per diode, T _j =25°C	660	W
Dielectric Strength	V _{dis}	Terminals to case, AC 1 minute	2	kV
Mounting Torque	TOR	(Recommended torque:0.3N·m)	0.5	N·m

● Electrical Characteristics (If not specified T_c=25°C)

Item	Symbol	Conditions	Ratings	Unit
Forward Voltage	V _F	I _F =15A, Pulse measurement, Rating of per diode	Max.0.63	V
Reverse Current	I _R	V _R =V _{RM} , Pulse measurement, Rating of per diode	Max.10	mA
Junction Capacitance	C _j	f=1MHz, V _R =10V, Rating of per diode	Typ.500	pF
Thermal Resistance	θ _{jc}	junction to case	Max.1.6	°C/W

SF30SC6

Forward Voltage

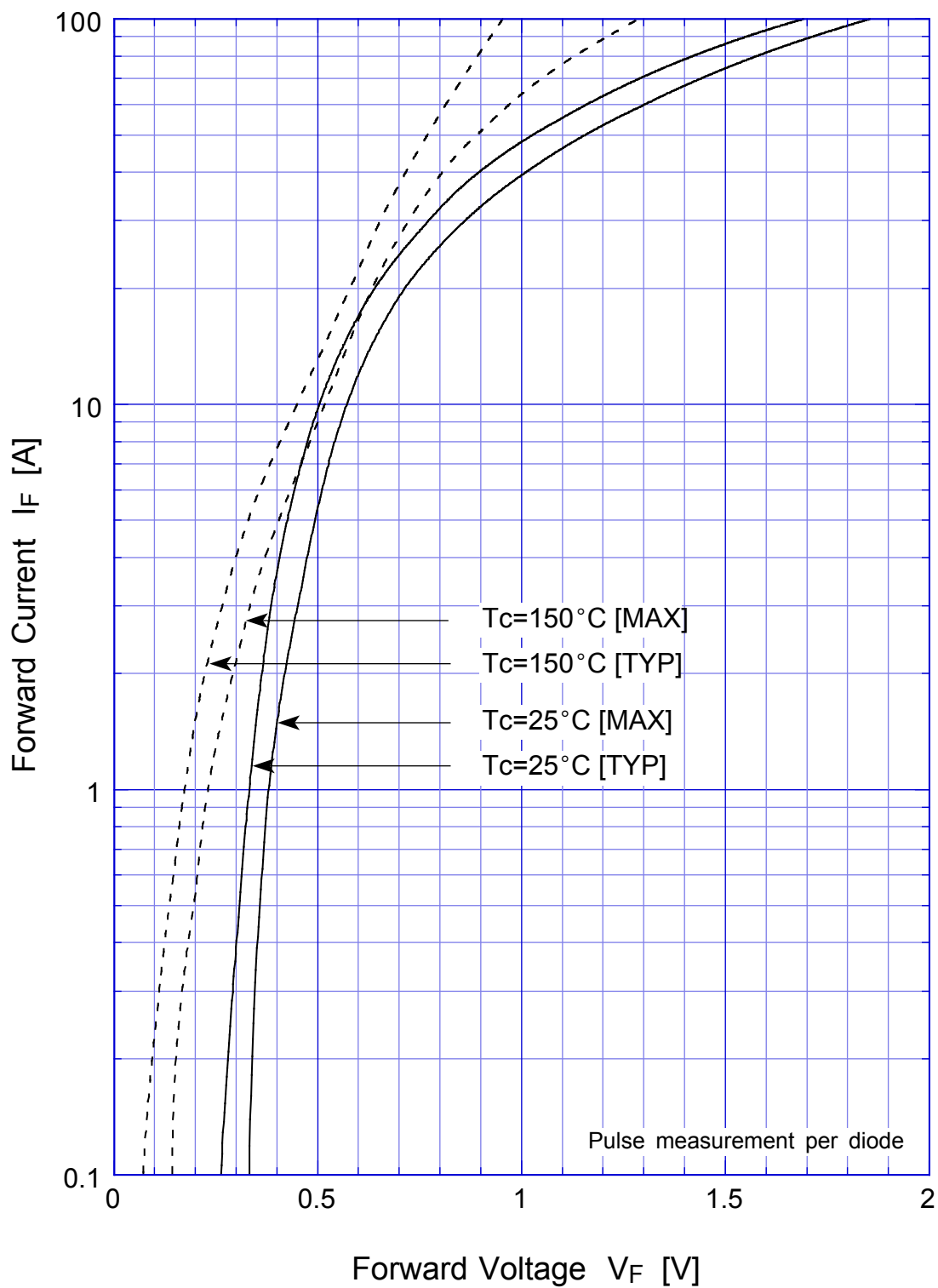

SF30SC6

Junction Capacitance

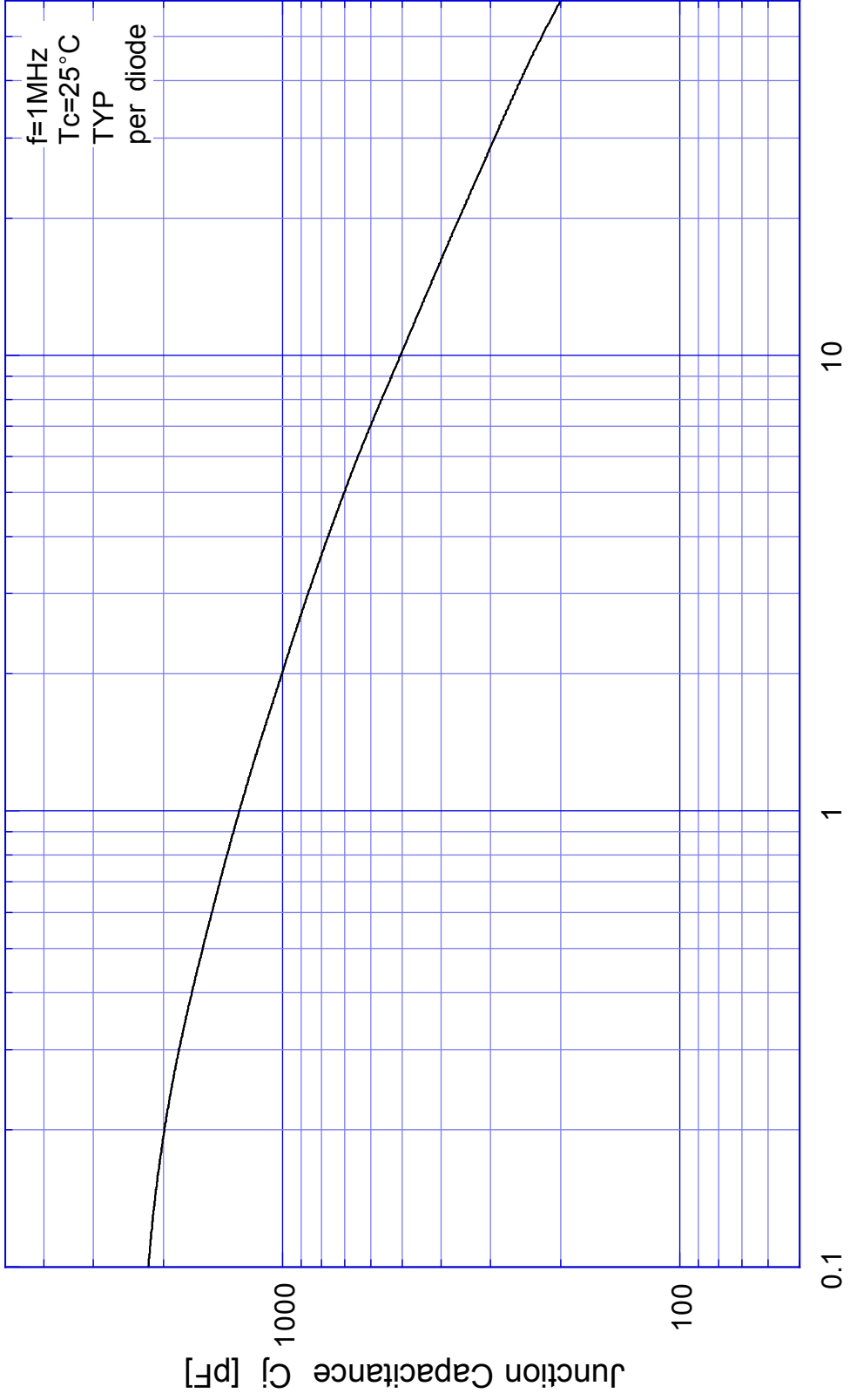

SF30SC6

Reverse Current

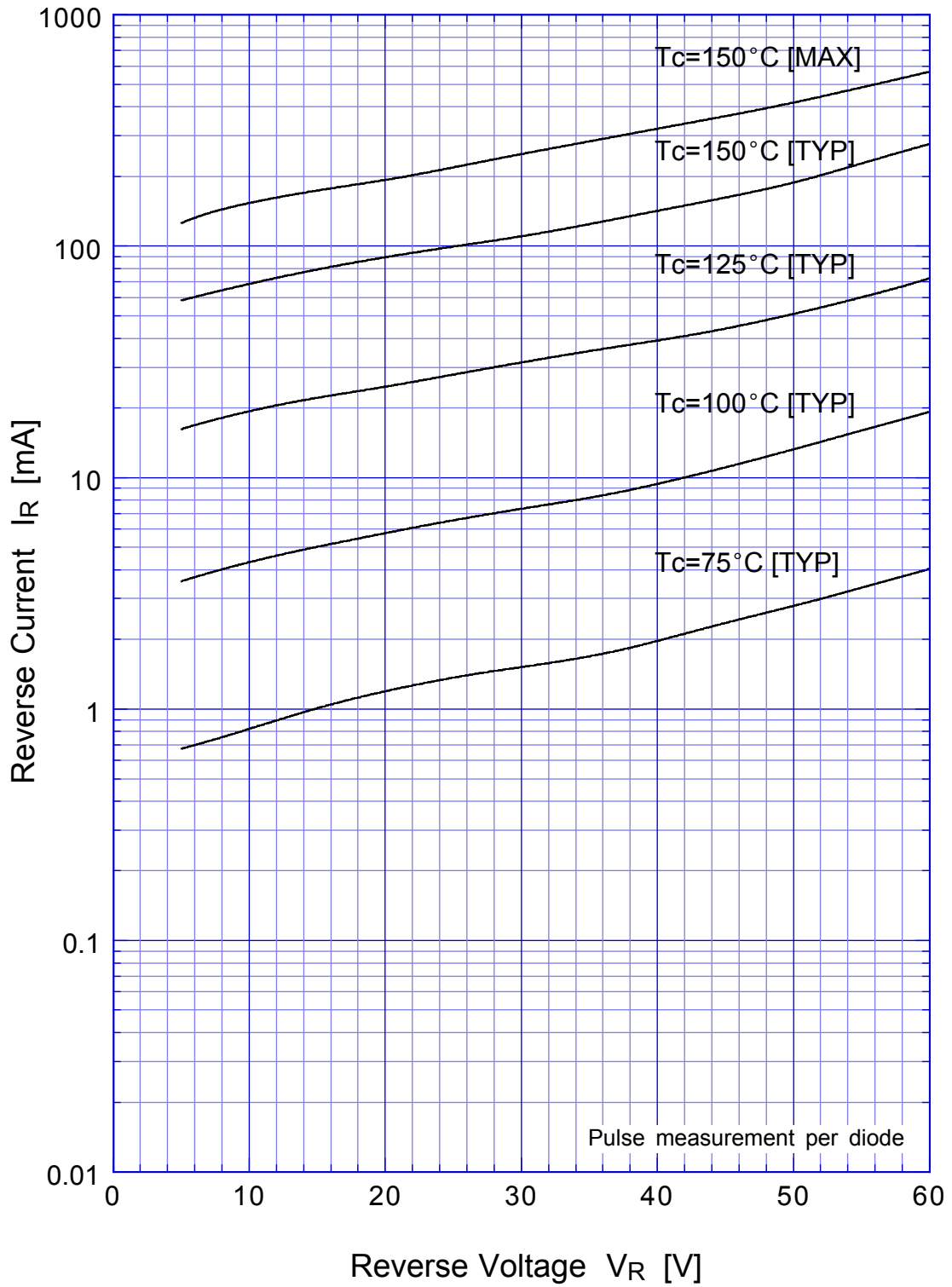

SF30SC6 Reverse Power Dissipation

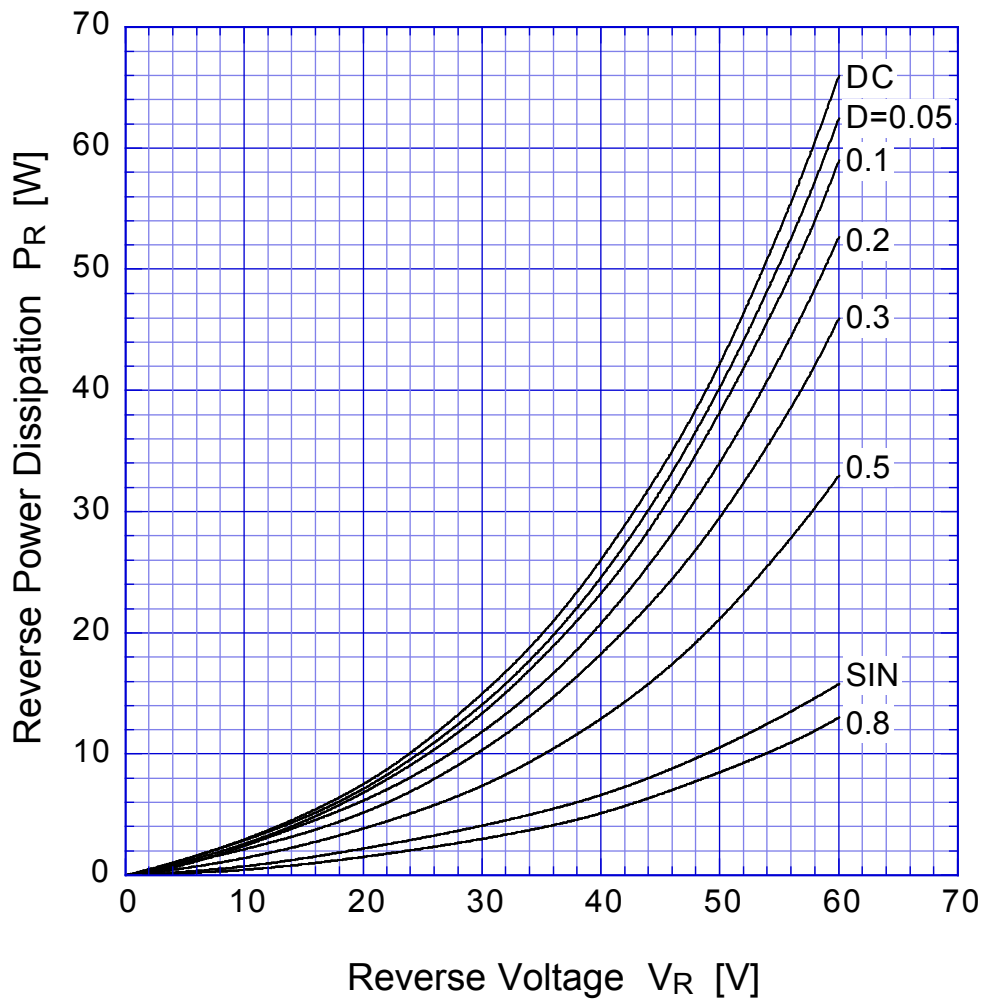

$T_j = 150^\circ\text{C}$



SF30SC6 Forward Power Dissipation

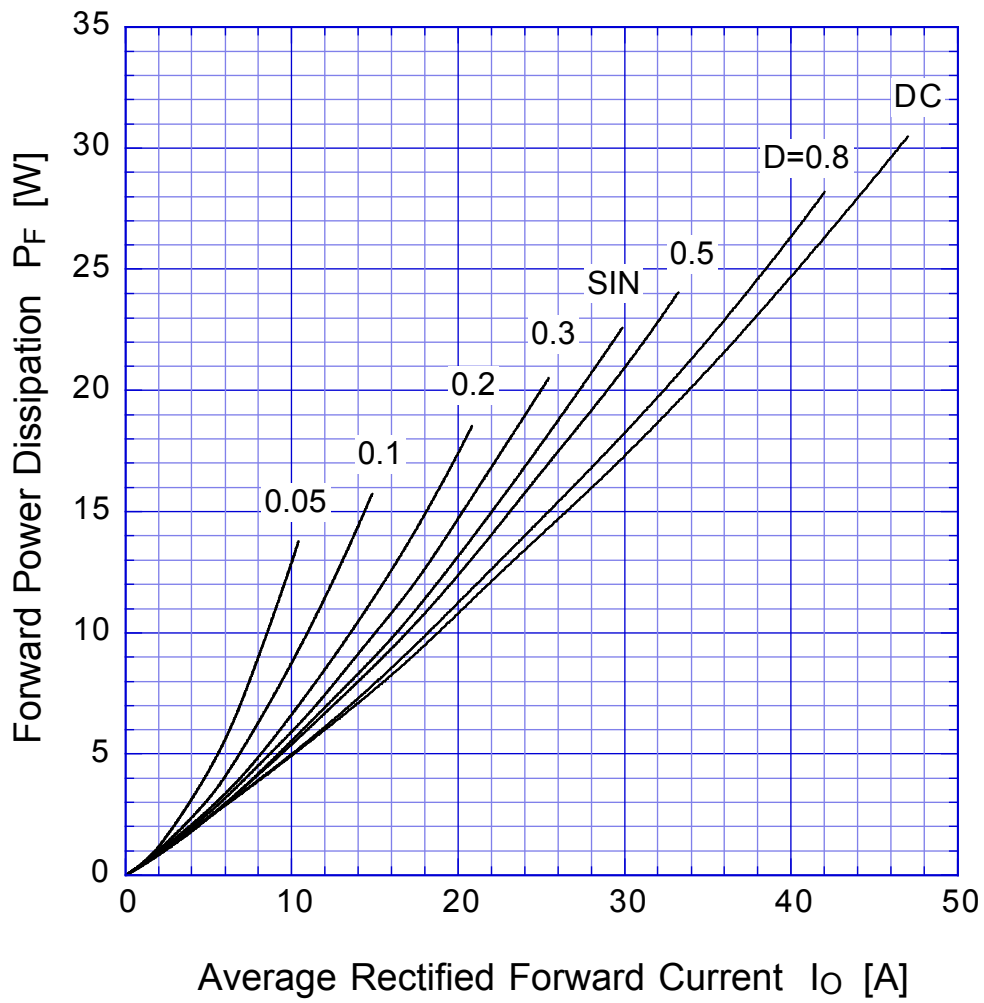

$T_j = 150^\circ\text{C}$

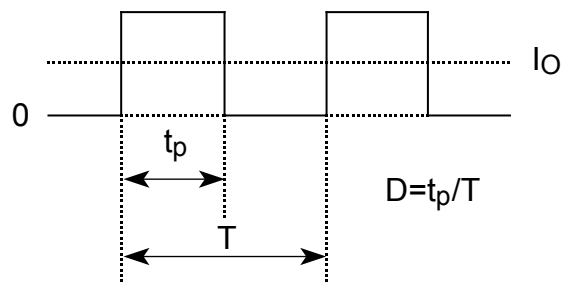

SF30SC6

Derating Curve

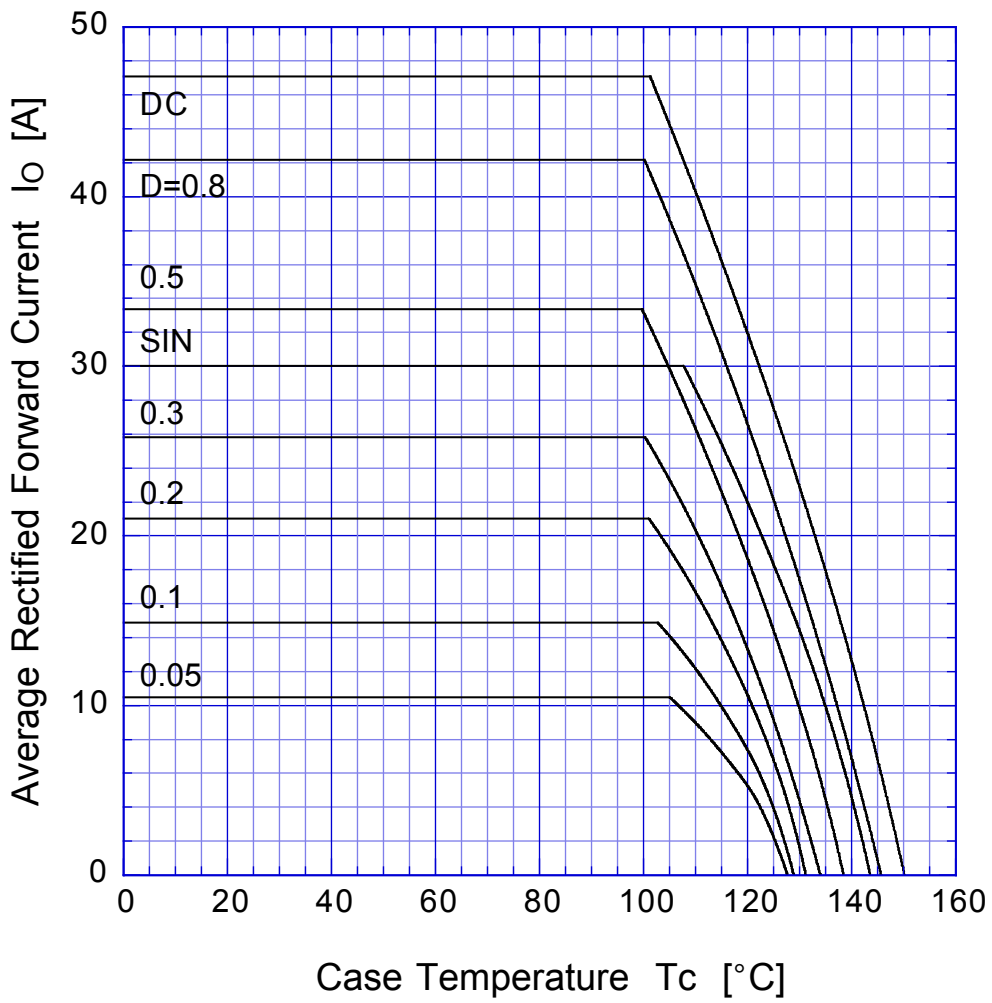

$V_R = 30V$



SF30SC6

Peak Surge Forward Capability

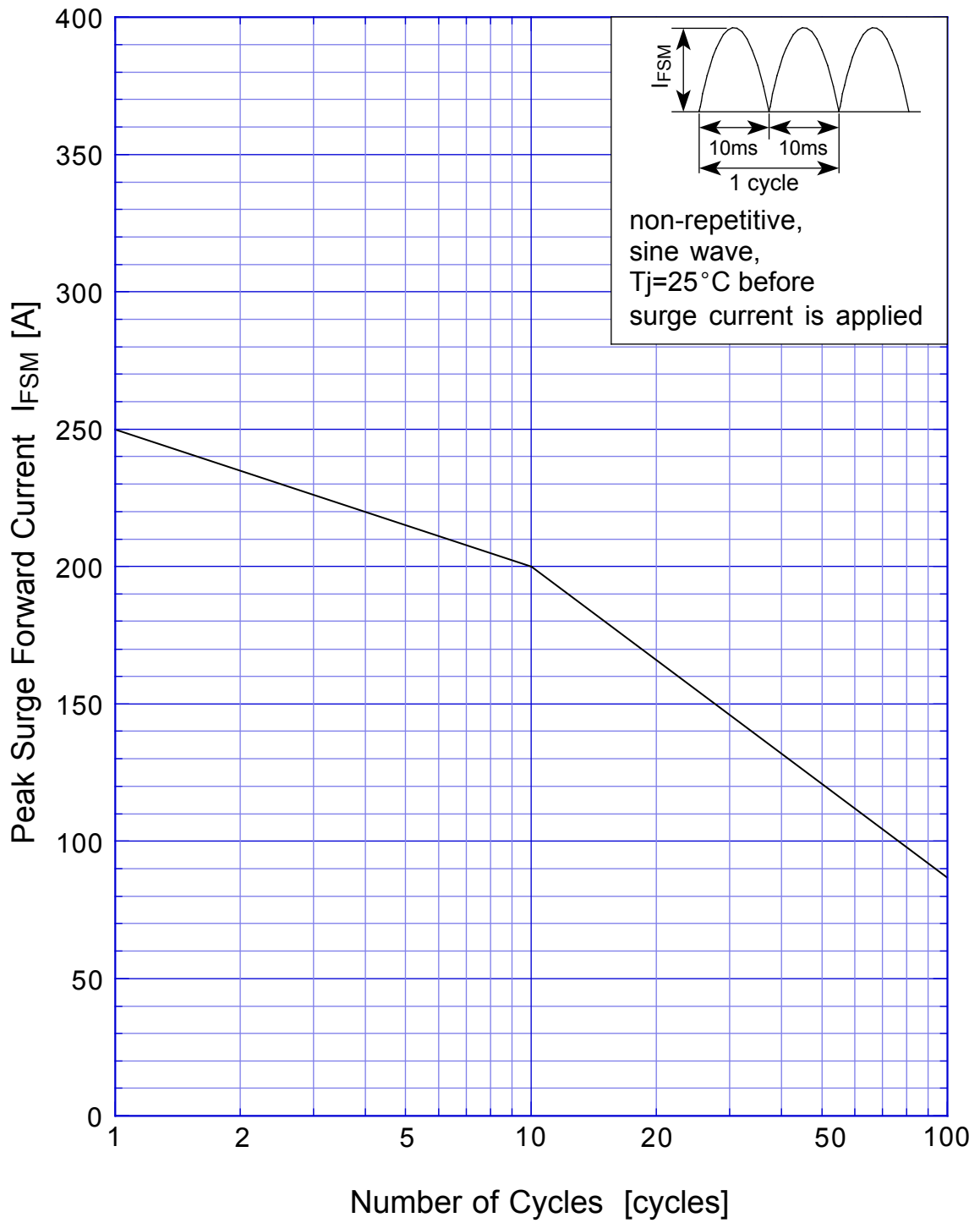

SBD Repetitive Surge Reverse Power Derating Curve

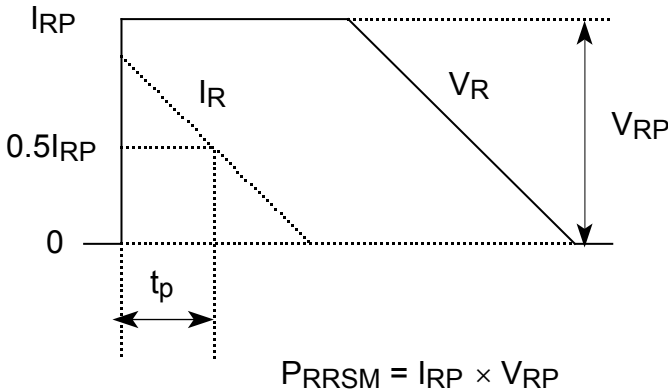
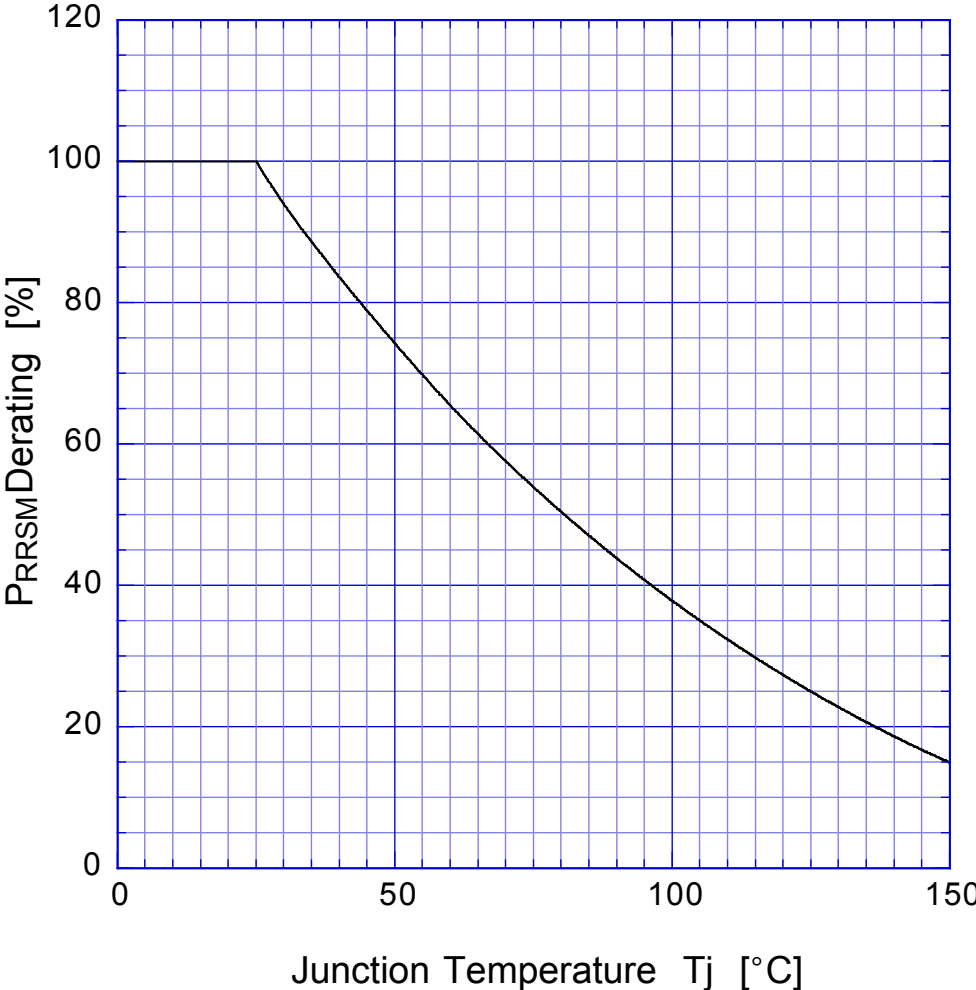

SBD

Repetitive Surge Reverse Power Capability

