

# SHINDENGEN

## Schottky Rectifiers (SBD)

Dual

# SF30SC3L

## 30V 30A

### FEATURES

- Tj150°C
- Low  $V_F=0.45V$
- $P_{RRSM}$  avalanche guaranteed
- Fully Isolated Molding
- Dielectric strength 2kV guaranteed

### APPLICATION

- Switching power supply
- DC/DC converter
- Home Appliances, Office Equipment
- Telecommunication

### OUTLINE DIMENSIONS

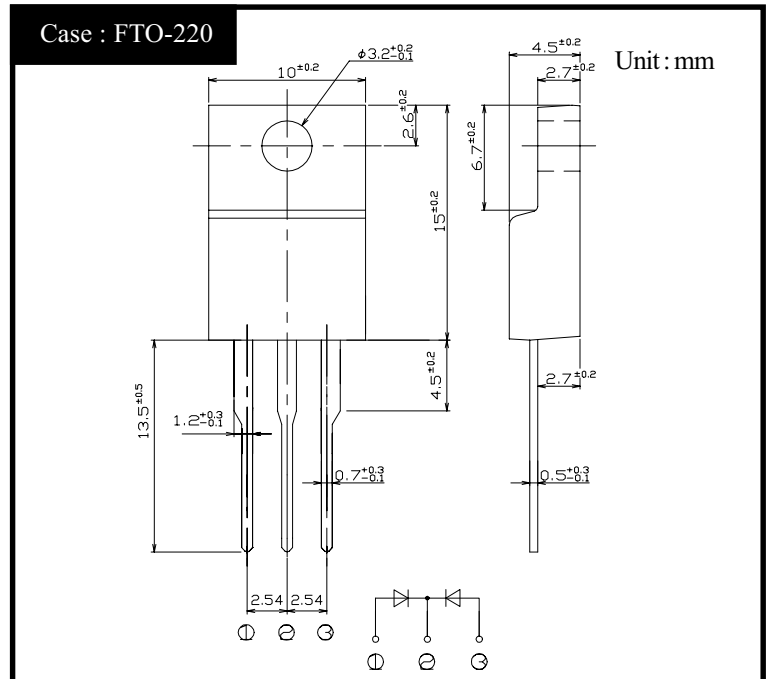

### RATINGS

#### ● Absolute Maximum Ratings (If not specified Tc=25°C)

Item	Symbol	Conditions	Ratings	Unit
Storage Temperature	Tstg		-55~150	°C
Operating Junction Temperature	Tj		150	°C
Maximum Reverse Voltage	V <sub>RM</sub>		30	V
Repetitive Peak Surge Reverse Voltage	V <sub>RRSM</sub>	Pulse width 0.5ms, duty 1/40	35	V
Average Rectified Forward Current	I <sub>O</sub>	50Hz sine wave, R-load, Rating for each diode I <sub>O</sub> /2, Tc=111°C	30	A
Peak Surge Forward Current	I <sub>FSM</sub>	50Hz sine wave, Non-repetitive 1 cycle peak value, Tj=25°C	350	A
Repetitive Peak Surge Reverse Power	P <sub>RRSM</sub>	Pulse width 10 μs, Rating of per diode, Tj=25°C	1000	W
Dielectric Strength	V <sub>dis</sub>	Terminals to case, AC 1 minute	2	kV
Mounting Torque	TOR	(Recommended torque:0.3N·m)	0.5	N·m

#### ● Electrical Characteristics (If not specified Tc=25°C)

Item	Symbol	Conditions	Ratings	Unit
Forward Voltage	V <sub>F</sub>	I <sub>F</sub> =12.5A, Pulse measurement, Rating of per diode	Max.0.45	V
Reverse Current	I <sub>R</sub>	V <sub>R</sub> =V <sub>RM</sub> , Pulse measurement, Rating of per diode	Max.15	mA
Junction Capacitance	C <sub>j</sub>	f=1MHz, V <sub>R</sub> =10V, Rating of per diode	Typ.960	pF
Thermal Resistance	θ <sub>jc</sub>	junction to case	Max.2.0	°C/W

# SF30SC3L Forward Voltage

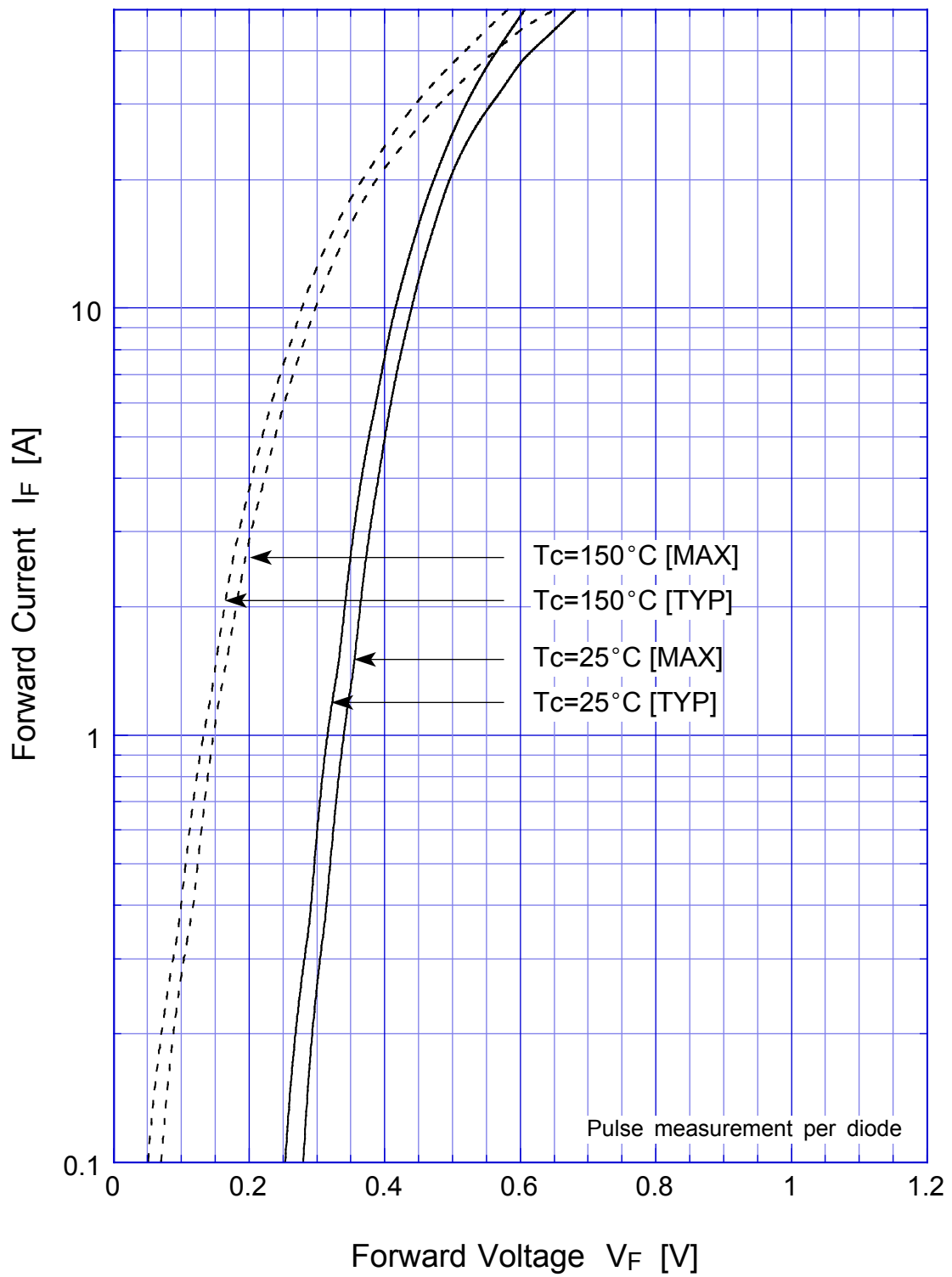

# SF30SC3L Junction Capacitance

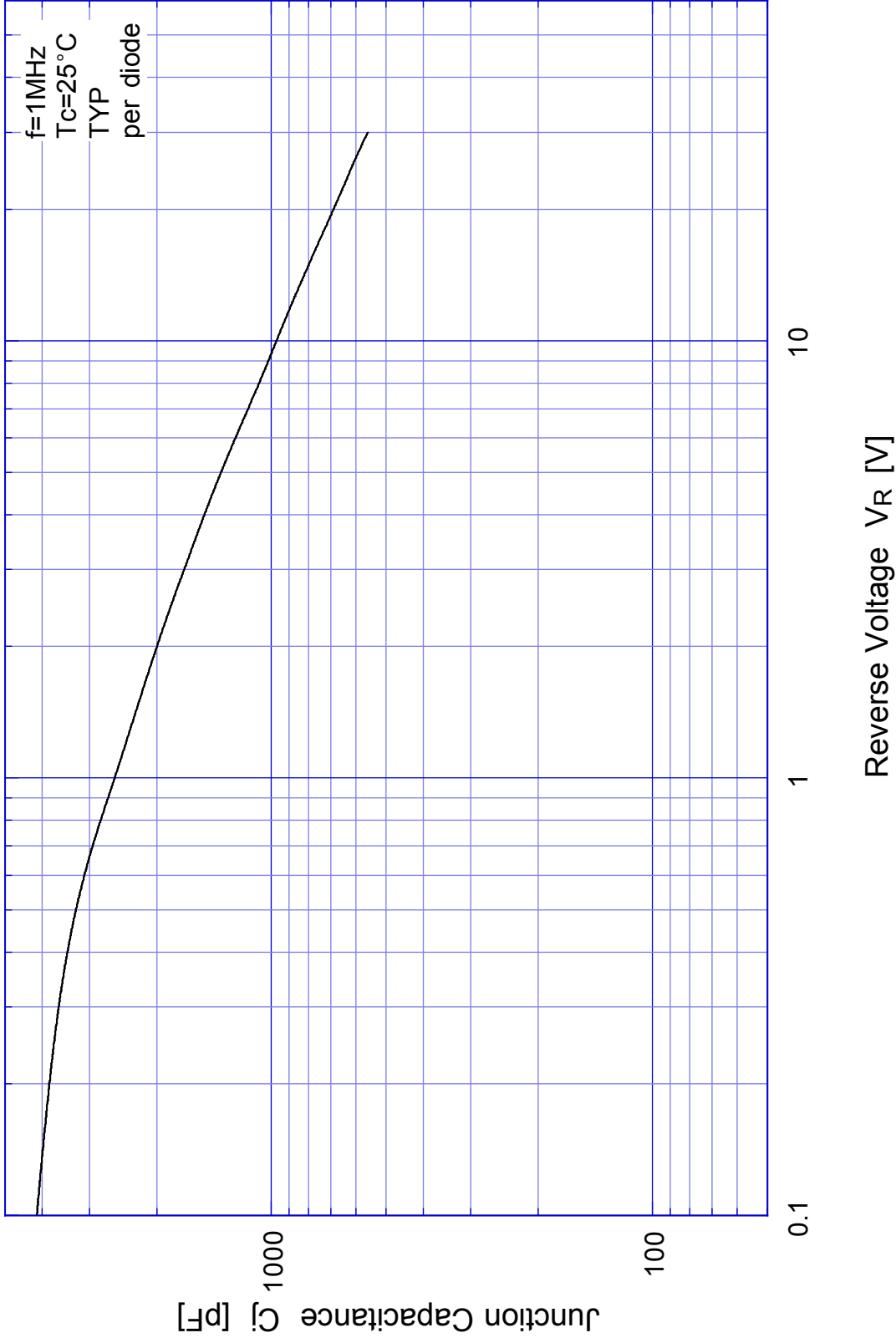

# SF30SC3L Reverse Current

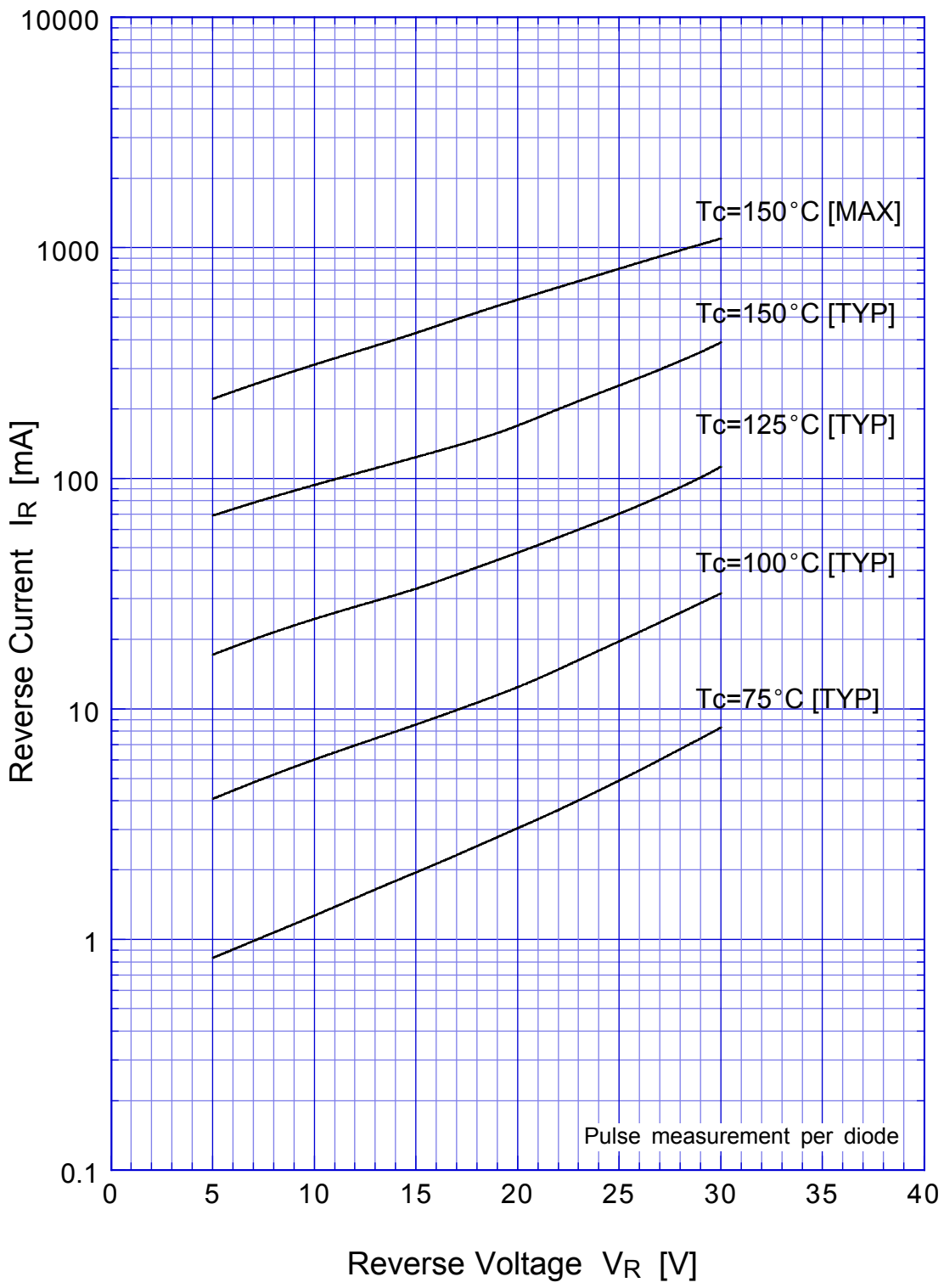

# SF30SC3L Reverse Power Dissipation

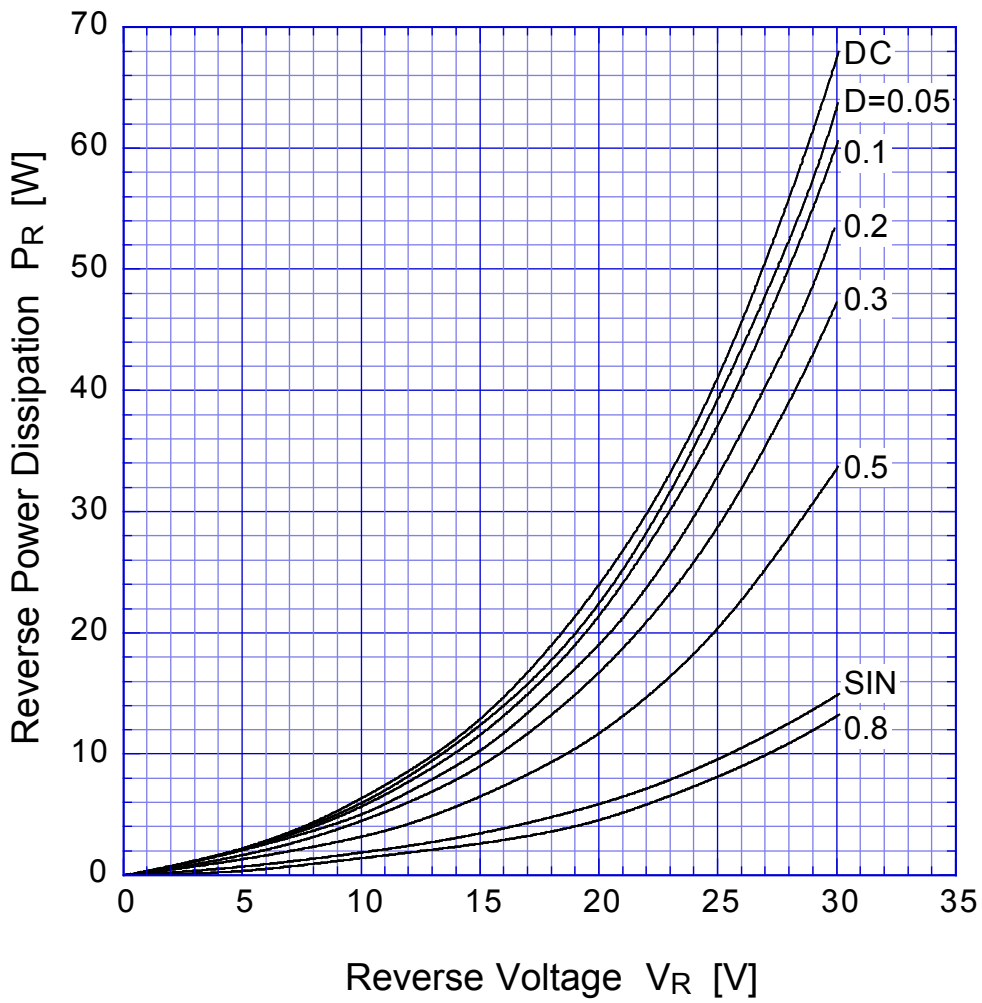

$T_j = 150^\circ\text{C}$

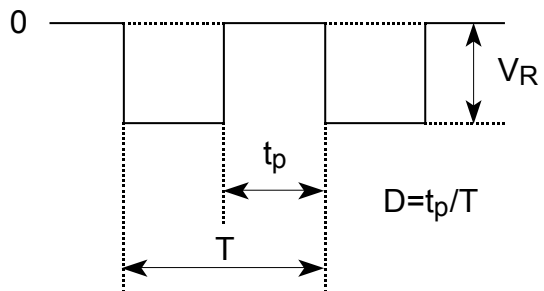

# SF30SC3L Forward Power Dissipation

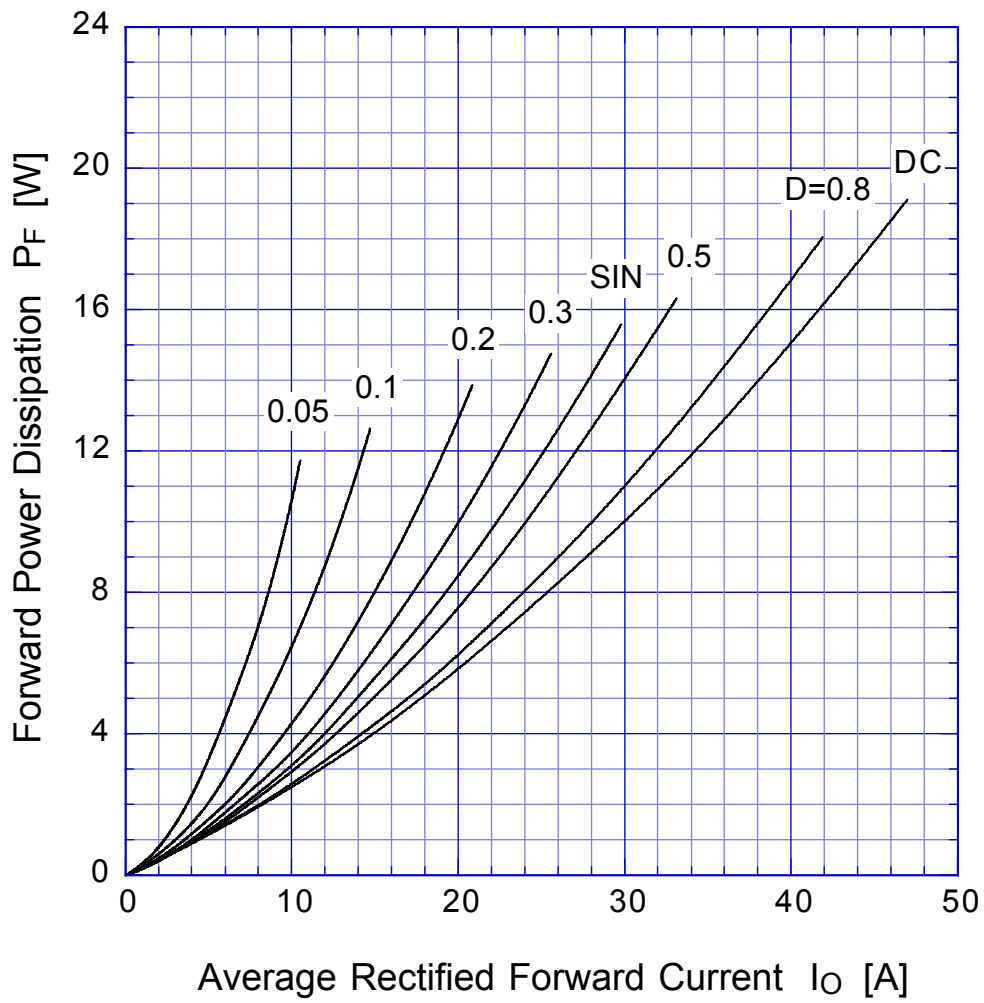

$T_j = 150^\circ\text{C}$

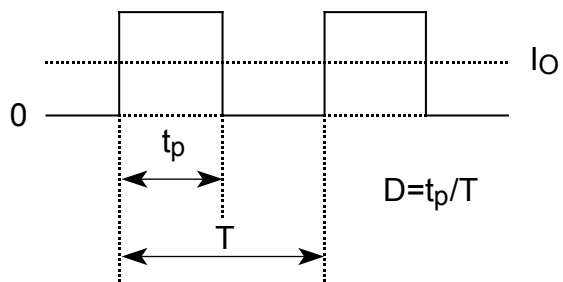

# SF30SC3L

# Derating Curve

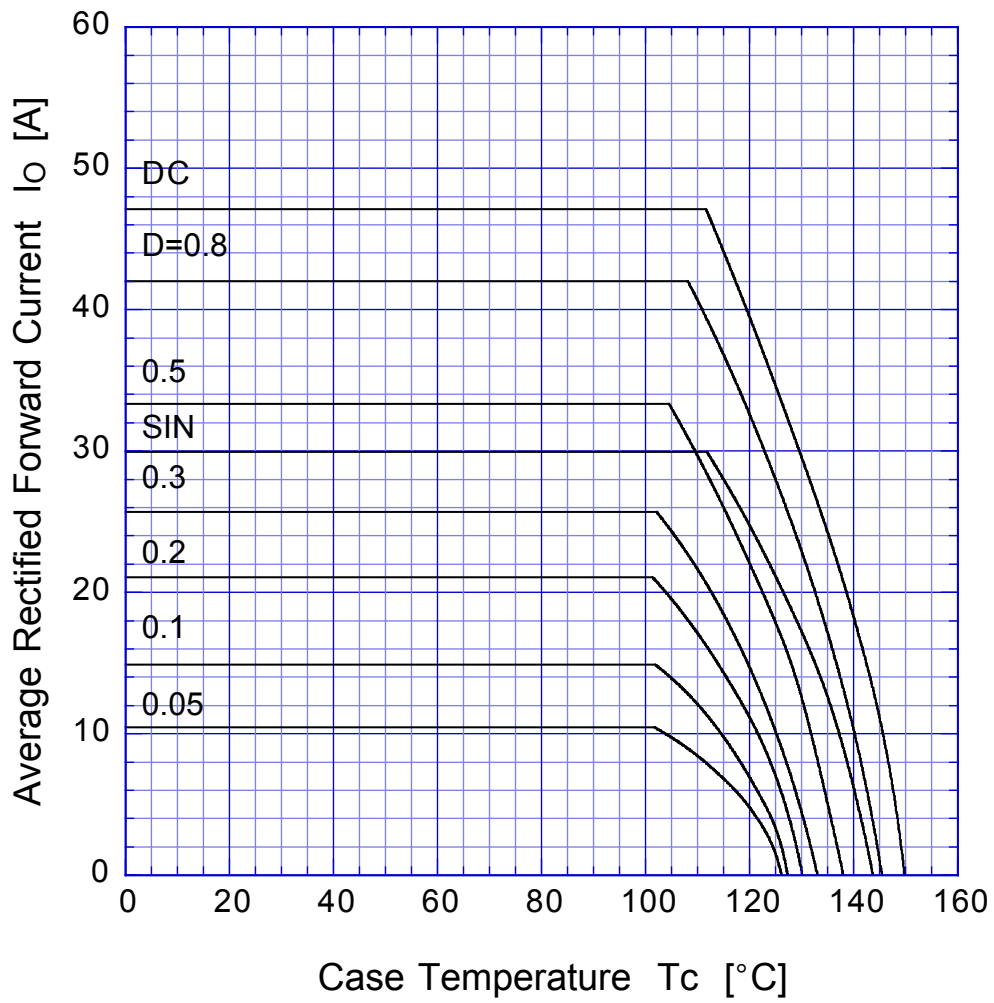

$V_R = 15V$



# SF30SC3L Peak Surge Forward Capability

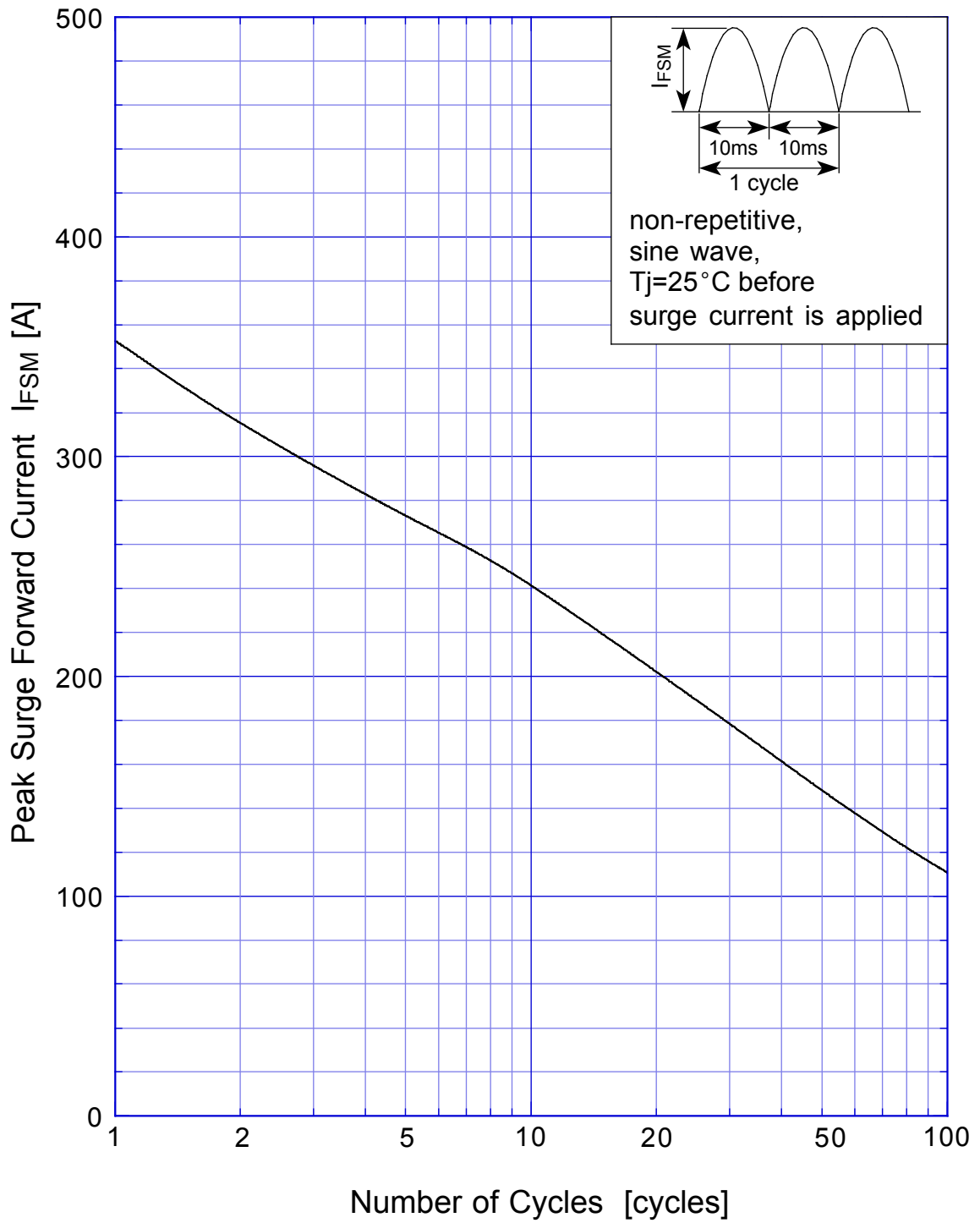



# SBD Repetitive Surge Reverse Power Derating Curve



# SBD

## Repetitive Surge Reverse Power Capability

