

FEATURES

- -55° to +125°C operation
- 16 to 40 VDC input
- Fully isolated
- Optocoupler feedback
- Fixed frequency, 550 kHz typical (400 kHz typ. 60 V output model)
- Topology – Flyback
- 50 V for up to 50 ms transient protection
- Inhibit function
- Indefinite short circuit protection
- Up to 76% efficiency, 16 W/in³

DC/DC CONVERTERS

28 VOLT INPUT

MSA SERIES

5 WATT



MODELS	
VDC OUTPUT	
SINGLE	DUAL
5	±5
5.2	±12
12	±15
15	
60	

Size (max.): 1.075 x 1.075 x 0.270 inches (27.31 x 27.31 x 6.86 mm)
Weight: 15 grams maximum.
Screening: Standard, ES, or 883 (Class H).

DESCRIPTION

The MSA Series™ of high frequency DC/DC converters offers a new standard of performance for low power, military/aerospace grade DC/DC converters. MSA parts provide up to 5 watts output power over the full military temperature range with up to 76% efficiency. Thick-film hybrid techniques provide military/aerospace reliability levels and optimum miniaturization. The hermetically sealed case is only 1.075 by 1.075 inches — with a height of only 0.270 inches. Power density for the MSA Series parts is 16 watts per cubic inch.

The MSA Series' small size, low height, and hermetically sealed metal enclosures make them ideal for use in military, aerospace and other high reliability applications. Units are available with standard, screening, "ES", and fully compliant SMD "883" screening. See page 8 for screening options and descriptions.

CONVERTER DESIGN

The MSA converters are switching regulators that use a flyback converter design with a constant switching frequency of 550 kHz. They are regulated, isolated units using a pulse width modulated topology and built as high reliability thick-film hybrids. Isolation between input and output circuits is provided with a transformer in the forward power path and an optical link in the feedback control loop. Excellent input line transient response and audio rejection is achieved by an advanced feed-forward compensation technique. Negative output regulation is maintained by tightly coupled magnetics. Up to 4 watts, 80% of the total output power, is available from either output, provided that the opposite output is simultaneously carrying 20% of the total power. Each output must carry a minimum of 20% of the total output power in order to maintain specified regulation on the negative output. Predictable current limit is accomplished by direct monitoring of the output load current, which results in a constant current output above the overload point. Internal input and output filters eliminate the need for external capacitors.

WIDE VOLTAGE RANGE

The MSA converters are designed to provide full power operation over a full 16 to 40 VDC voltage range. Operation below 16 volts, including MIL-STD-704E emergency power conditions is possible with derated power. Please refer to the low line dropout graphs (Figures 17 and 18) for details. A low voltage lockout feature keeps the converter shutdown below approximately 13 VDC to ensure smooth initialization.

IMPROVED DYNAMIC RESPONSE

The MSA feed-forward compensation system provides excellent dynamic response and noise rejection. Audio rejection is typically 50 dB. The minimum to maximum step line transient response is typically less than 1%.

INHIBIT FUNCTION

MSA converters provide a TTL open collector-compatible inhibit feature that can be used to disable internal switching and inhibit the unit's output. Inhibiting in this manner results in low standby current, and no generation of switching noise.

The converter is inhibited when the TTL compatible low (≤ 0.8 V) is applied to the inhibit pin. The unit is enabled when the pin, which is internally connected to a pull-up resistor, is left unconnected or is connected to an open collector gate. The open circuit output voltage associated with the inhibit pin is 9 to 11 V. In the inhibit mode, a maximum of 4 mA must be sunk from the inhibit pin.

UNDERVOLTAGE LOCKOUT AND TRANSIENT PROTECTION

Undervoltage lockout helps keep system current levels low during initialization or re-start operations. They can withstand short term transients of up to 50 volts without damage.



interpoint
A CRANE CO. COMPANY

MSA SERIES 5 WATT

DC/DC CONVERTERS

ABSOLUTE MAXIMUM RATINGS

- Input Voltage**
 - 16 to 40 V
- Output Power**
 - 5 watts
- Lead Soldering Temperature (10 sec per lead)**
 - 300°C
- Storage Temperature Range (Case)**
 - -65°C to +135°C

INHIBIT

- Inhibit TTL Open Collector**
 - Logic low (output disabled)
 - Logic low voltage ≤ 0.8 V max
 - Inhibit pin current 4 mA max
 - Referenced to input common
 - Logic high (output enabled)
 - Open collector

TYPICAL CHARACTERISTICS

- Output Voltage Temperature Coefficient**
 - 100 ppm/°C typical
- Input to Output Capacitance**
 - 50 pF typical
- Isolation**
 - 100 megohm minimum at 500 V
- Audio Rejection**
 - 50 dB typical
- Conversion Frequency**
 - 550 kHz typical (400 kHz 60 V model)
 - 450 kHz min, 600 kHz max
 - 350 kHz min, 450 kHz max 60 V model
- Inhibit Pin Voltage (unit enabled)**
 - 9 to 11 V

RECOMMENDED OPERATING CONDITIONS

- Input Voltage Range**
 - 16 to 40 VDC continuous
 - 50 V for up to 50 msec transient
- Case Operating Temperature (Tc)**
 - -55°C to +125°C full power
 - -55°C to +135°C absolute
- Derating Output Power/Current (Tc)**
 - Linearly from 100% at 125°C to 0% at 135°C

Electrical Characteristics: 25°C Tc, 28 VDC Vin, 100% load, unless otherwise specified.

SINGLE OUTPUT MODELS		MSA2805S			MSA285R2S			MSA2812S			MSA2815S			MSA2860S ¹			UNITS
PARAMETER	CONDITIONS	MIN	TYP	MAX	MIN	TYP	MAX	MIN	TYP	MAX	MIN	TYP	MAX	MIN	TYP	MAX	
OUTPUT VOLTAGE	Tc = -55°C TO +125°C	4.95	5.00	5.05	5.15	5.20	5.25	11.88	12.00	12.12	14.85	15.00	15.15	59.1	60.00	60.9	VDC
OUTPUT CURRENT	Tc = -55°C TO +125°C	VIN = 16 TO 40 VDC			VIN = 16 TO 40 VDC			VIN = 16 TO 40 VDC			VIN = 16 TO 40 VDC			VIN = 16 TO 40 VDC			mA
OUTPUT POWER	Tc = -55°C TO +125°C	VIN = 16 TO 40 VDC			VIN = 16 TO 40 VDC			VIN = 16 TO 40 VDC			VIN = 16 TO 40 VDC			VIN = 16 TO 40 VDC			
OUTPUT RIPPLE VOLTAGE	10 kHz - 2 MHz	—	125	350	—	110	335	—	50	200	—	50	170	—	—	300	mV p-p
LINE REGULATION	VIN = 16 TO 40 VDC Tc = -55°C TO +125°C	—	10	50 ²	—	10	50	—	10	50	—	10	50	—	—	300	mV
LOAD REGULATION	NO LOAD TO FULL Tc = -55°C TO +125°C	—	10	50	—	10	50	—	10	50	—	10	50	—	—	300	mV
INPUT VOLTAGE NO LOAD TO FULL	Tc = -55°C TO +125°C CONTINUOUS	16	28	40	16	28	40	16	28	40	16	28	40	16	28	40	VDC
INPUT CURRENT	NO LOAD	—	27	40	—	28	40	—	29	42	—	31	44	—	—	30	mA
	FULL LOAD	—	250	—	—	250	—	—	235	—	—	235	—	—	72	—	
	INHIBITED	—	3	5	—	3	5	—	3	5	—	3	5	—	3	5	
INPUT RIPPLE CURRENT	10 kHz - 10 MHz Tc = -55°C TO +125°C	—	25	100	—	25	100	—	25	100	—	25	100	—	—	90	mA p-p
EFFICIENCY		66	71	—	66	71	—	70	76	—	71	76	—	70	75	—	
LOAD FAULT ^{3, 4}	POWER DISSIPATION	—	1.5	2.0	—	1.5	2.0	—	1.2	1.9	—	1.2	1.8	—	—	—	W
SHORT CIRCUIT	RECOVERY	—	12.5	25	—	1.5	25	—	1	10	—	1	10	—	—	—	ms
STEP LOAD RESPONSE ^{4, 5}	50% - 100% - 50% TRANSIENT	—	100	250	—	100	250	—	150	375	—	200	500	—	—	—	mV pk
STEP LINE RESPONSE ^{4, 5}	RECOVERY	—	100	250	—	100	250	—	200	500	—	200	500	—	—	—	μs
	16 TO 40 VIN	—	50	150	—	50	150	—	80	200	—	50	125	—	—	—	mV pk
	40 TO 16 VIN	—	50	150	—	50	150	—	100	250	—	50	125	—	—	—	
	RECOVERY	—	100	250	—	100	250	—	250	625	—	250	625	—	—	—	μs
16 TO 40 VIN	—	100	250	—	100	250	—	250	625	—	250	625	—	—	—		
START-UP	DELAY	—	10	25	—	10	25	—	3	10	—	3	10	—	—	—	ms
	OVERSHOOT	—	0	50	—	0	50	—	0	120	—	0	150	—	—	—	mV pk

Notes

- MSA2860S specifications are at 25°C Tc only, contact your Interpoint representative for more information on over temperature specs.
- Line regulation for /ES and non /ES 2805S models at 16 to 17 VIN and 110 °C to 125°C (case) is 5% (max).
- Indefinite short circuit protection not guaranteed above 125°C (case).
- Recovery time is measured from application of the transient to point at which VOUT is within 1% of VOUT at final value.
- Transition time >10μs.

DC/DC CONVERTERS

MSA SERIES 5 WATT

Electrical Characteristics: 25°C Tc, 28 VDC Vin, 100% load, unless otherwise specified.

DUAL OUTPUT MODELS		MSA 2805D			MSA2812D			MSA2815D			UNITS	
PARAMETER	CONDITIONS	MIN	TYP	MAX	MIN	TYP	MAX	MIN	TYP	MAX		
OUTPUT VOLTAGE	+V _{OUT}	4.95	5.00	5.05	11.88	12.00	12.12	14.85	15.00	15.15	VDC	
	-V _{OUT}	4.9	5.0	5.1	11.76	12.00	12.24	14.70	15.00	15.30		
OUTPUT CURRENT ¹	V _{IN} = 16 to 40 VDC Tc = -55°C to +125°C	—	±500	800	—	±208	333	—	±167	267	mA	
OUTPUT POWER ¹	V _{IN} = 16 to 40 VDC Tc = -55°C to +125°C	—	—	5	—	—	5	—	—	5	W	
OUTPUT RIPPLE VOLT.	10 kHz - 2 MHz	—	—	150	—	40	140	—	60	150	mV p-p	
LINE REGULATION Vin = 16 to 40 VDC	Tc = -55°C to +125°C	—	10	25	—	10	50	—	10	50	mV	
	+V _{OUT} -V _{OUT}	—	40	75	—	40	180	—	40	180		
LOAD REGULATION NO LOAD TO FULL	Tc = -55°C to +125°C	—	10	50	—	10	50	—	10	50	mV	
	+V _{OUT} -V _{OUT}	—	50	200	—	50	200	—	50	200		
CROSS REGULATION ²	+P _O = 20 - 80 %, -P _O = 80 - 20% -P _O = 20 - 80 %, +P _O = 80 - 20%	—	10	20	—	8	15	—	7	15	%	
	+P _O = 50 - 10 %, -P _O = 50% -P _O = 50 - 10 %, +P _O = 50%	—	5	8	—	3.7	6	—	3	6		
INPUT VOLTAGE Tc = -55°C to +125°	NO LOAD TO FULL CONTINUOUS	16	28	40	16	28	40	16	28	40	VDC	
	TRANSIENT 50 msec	—	—	50	—	—	50	—	—	50	V	
INPUT CURRENT Tc = -55°C to +125°C	NO LOAD	—	30	35	—	33	58	—	38	60	mA	
	FULL LOAD	—	248	—	—	235	—	—	235	—		
	INHIBITED	—	3	5	—	3	5	—	3	5		
INPUT RIPPLE CURRENT	10 kHz TO 10 MHz	—	25	80	—	25	100	—	25	100	mA p-p	
	Tc = -55°C to +125°C	—	30	160	—	30	150	—	30	150		
EFFICIENCY		68	72	—	69	75	—	70	75	—	%	
LOAD FAULT ^{3, 4}	POWER DISSIPATION SHORT CIRCUIT	—	1.3	1.8	—	1.3	1.7	—	1.3	1.6	W	
	RECOVERY	—	—	50	—	1	10	—	1	10	ms	
STEP LOAD RESPONSE ^{4, 5}	50% - 100% - 50% BALANCED TRANSIENT	—	—	±150	—	±300	±750	—	±300	±750	mV	
	RECOVERY	—	—	100	—	200	500	—	500	1250	µs	
STEP LINE RESP. ^{4, 5}	TRANSIENT	16 TO 40 VDC	—	—	±750	—	±50	±125	—	±150	±375	mV pk
		40 TO 16 VDC	—	—	±500	—	±50	±125	—	±100	±250	
	RECOVERY	16 TO 40 VDC	—	—	1200	—	150	375	—	250	625	µs
		40 TO 16 VDC	—	—	1200	—	400	1000	—	800	2000	
START-UP	DELAY	—	—	25	—	3	10	—	3	10	ms	
	OVERSHOOT	—	—	500	—	0	120	—	0	150	mV pk	

Notes

- Up to 4 watts (80% of full power) is available from either output providing the opposite output is carrying 20% of total power.
- Shows regulation effect on the minus output during the defined cross loading conditions. See Figures 15 and 16.
- Indefinite short circuit protection not guaranteed above 125°C (case).
- Recovery time is measured from application of the transient to point at which V_{OUT} is within 1% of V_{OUT} at final value.
- Transition time >10µs.

MSA SERIES 5 WATT

DC/DC CONVERTERS

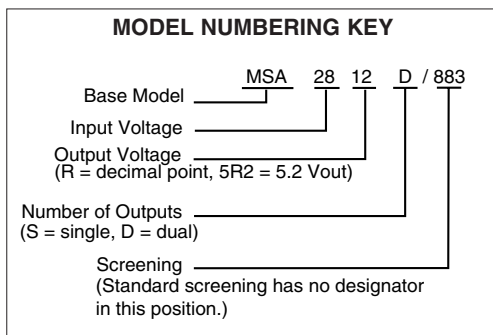
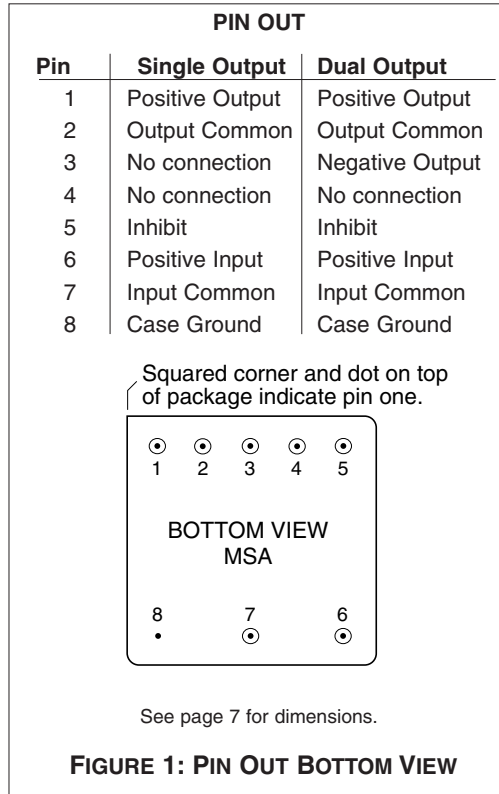

SMD NUMBERS

STANDARD MICROCIRCUIT DRAWING (SMD)	MSA SERIES SIMILAR PART
5962-9309201HXC	MSA2805S/883
IN PROCESS	MSA285R2S/883
5962-9309301HXC	MSA2812S/883
5962-9309401HXC	MSA2815S/883
5962-0052201HXC	MSA2860S/883
5962-9308901HXC	MSA2812D/883
5962-9309001HXC	MSA2815D/883

For exact specifications for an SMD product, refer to the SMD drawing. Call your Interpoint representative for status on MSA SMD releases. "883" suffix indicates SMD similar part. SMDs can be downloaded from:
<http://www.dsccl.dla.mil/programs/smcr>

DC/DC CONVERTERS

MSA SERIES 5 WATT

Typical Performance Curves: 25°C Tc, 28 VDC Vin, 100% load, unless otherwise specified.

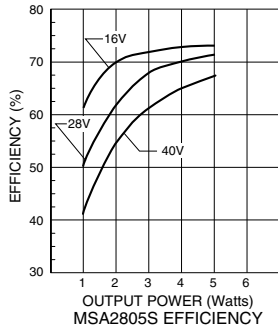

FIGURE 2

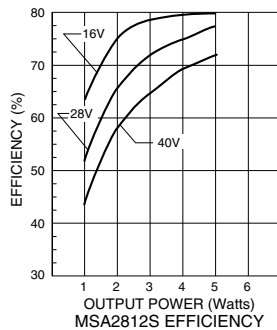

FIGURE 3

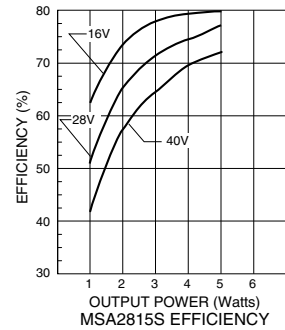

FIGURE 4

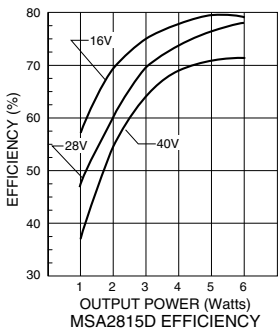

FIGURE 5

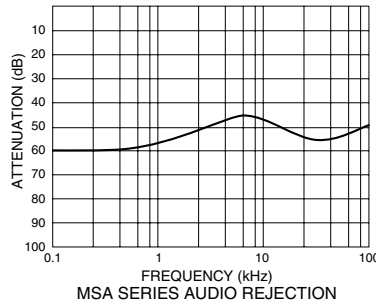

FIGURE 6

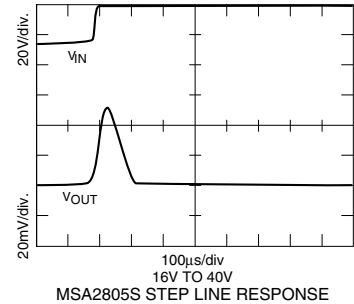

FIGURE 7

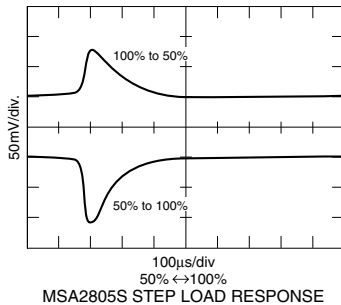

FIGURE 8

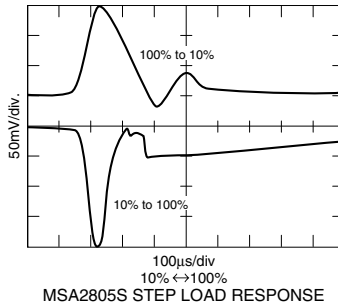

FIGURE 9

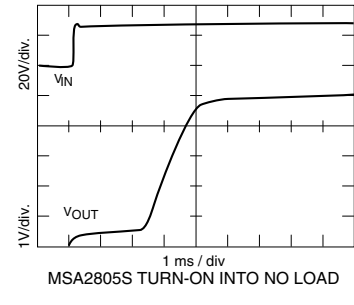

FIGURE 10

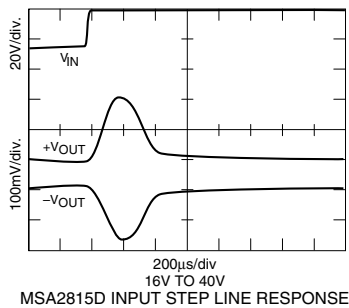

FIGURE 11

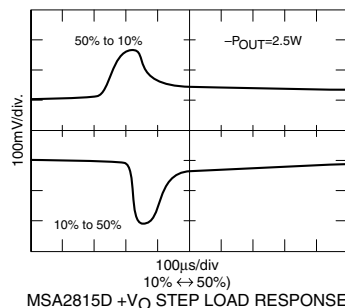

FIGURE 12

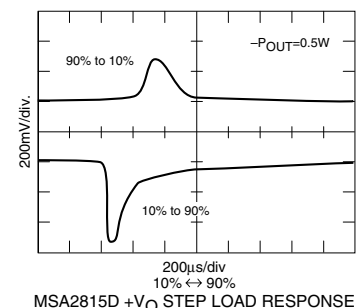

FIGURE 13

Typical Performance Curves: 25°C Tc, 28 VDC Vin, 100% load, unless otherwise specified.

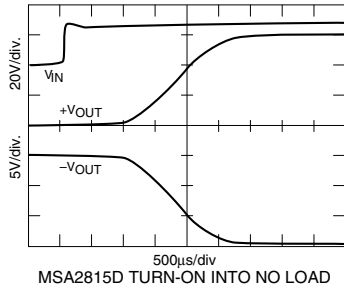

FIGURE 14

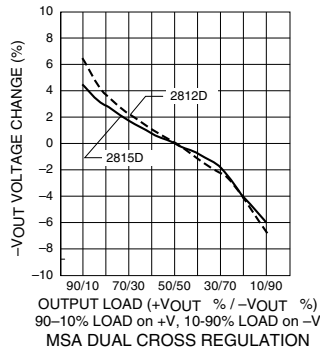

FIGURE 15

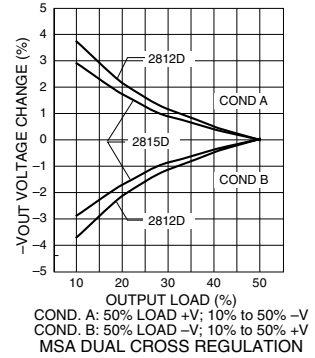

FIGURE 16

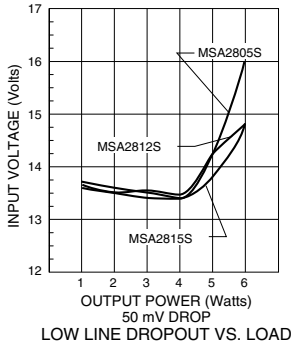

FIGURE 17

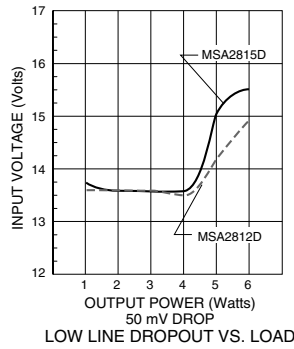
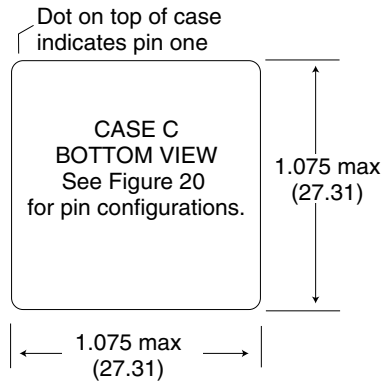

FIGURE 18



Materials

Header Cold Rolled Steel/Nickel/Gold
 Cover Cold Rolled Steel/Nickel
 Pins Copper/Nickel/Gold
 compression glass seal

Case dimensions in inches (mm)

Tolerance
 ± 0.005 (0.13) for three decimal places
 ± 0.01 (0.3) for two decimal places
 unless otherwise specified

CAUTION

Heat from reflow or wave soldering may damage the device. Solder pins individually with heat application not exceeding 300°C for 10 seconds per pin.

FIGURE 19: CASE C MAXIMUM DIMENSIONS

BOTTOM VIEW CASE C1
 MSA Series: Screening – Standard, ES, or 883

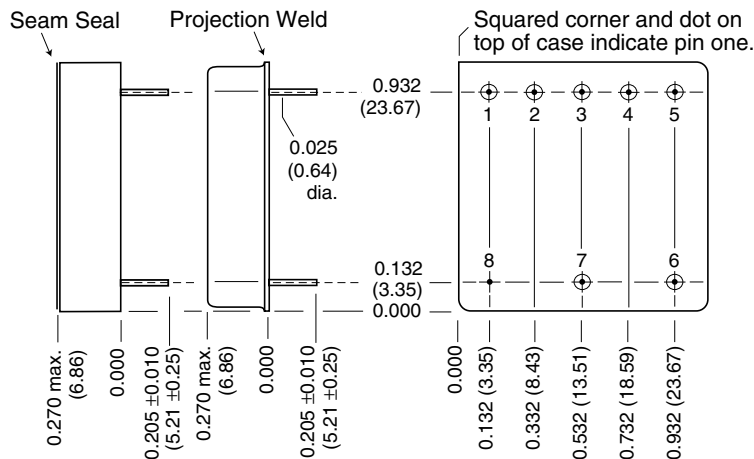

FIGURE 20: CASE C1

Note: Although every effort has been made to render the case drawings at actual size, variations in the printing process may cause some distortion. Please refer to the numerical dimensions for accuracy.

ENVIRONMENTAL SCREENING

TEST (125°C Products)	STANDARD	/ES	/883 (Class H)*
PRE-CAP INSPECTION Method 2017, 2032	yes	yes	yes
TEMPERATURE CYCLE (10 times) Method 1010, Cond. C, -65°C to 150°C Method 1010, Cond. B, -55°C to 125°C	no no	no yes	yes no
CONSTANT ACCELERATION Method 2001, 3000 g Method 2001, 500 g	no no	no yes	yes no
BURN-IN Method 1015, 160 hours at 125°C 96 hours at 125°C case (typical)	no no	no yes	yes no
FINAL ELECTRICAL TEST MIL-PRF-38534, Group A Subgroups 1 through 6: -55°C, +25°C, +125°C Subgroups 1 and 4: +25°C case	no yes	no yes	yes no
HERMETICITY TESTING Fine Leak, Method 1014, Cond. A Gross Leak, Method 1014, Cond. C Gross Leak, Dip (1 x 10 ⁻³)	no no yes	yes yes no	yes yes no
FINAL VISUAL INSPECTION Method 2009	yes	yes	yes

Test methods are referenced to MIL-STD-883 as determined by MIL-PRF-38534.

*883 products are built with element evaluated components and are 100% tested and guaranteed over the full military temperature range of -55°C to +125°C.

Contact Information:

www.interpoint.com

Interpoint Headquarters USA
Phone: 1-800-822-8782
+425-882-3100
Email: power@intp.com

Interpoint UK
Phone: +44-1252-815511
Email: poweruk@intp.com

Interpoint France
Phone: +33-134285455
Email: powerfr@intp.com