

General Description

The AAT2860-x is a highly integrated charge pump-based lighting management unit (LMU) with three low dropout (LDO) regulators optimized for single-cell lithium-ion/polymer systems. The charge pump provides power for all LED outputs; multiple backlight and flash LED configurations are available. The backlight LED outputs can be programmed up to 31mA each and the flash LED outputs can be programmed up to 300mA each. An I²C compatible serial digital interface is used to enable, disable, and set the current to one of 32 levels for the backlight and one of 16 levels for the flash. A programmable safety timer and flash control input is included for easy flash control. Backlight current matching is better than 3% for uniform display brightness, and flash current matching is better than 5% for uniform power dissipation.

The AAT2860-x offers three high-performance low-noise MicroPower™ LDO linear regulators. The regulators are enabled and their output voltages are set through the I²C compatible serial interface. Each LDO can supply up to 300mA load current and ground-pin current is only 80µA making the AAT2860-x ideal for battery-operated applications.

The AAT2860-x is available in a Pb-free, space saving TQFN34-24 package and operates over the -40°C to +85°C ambient temperature range.

Typical Application

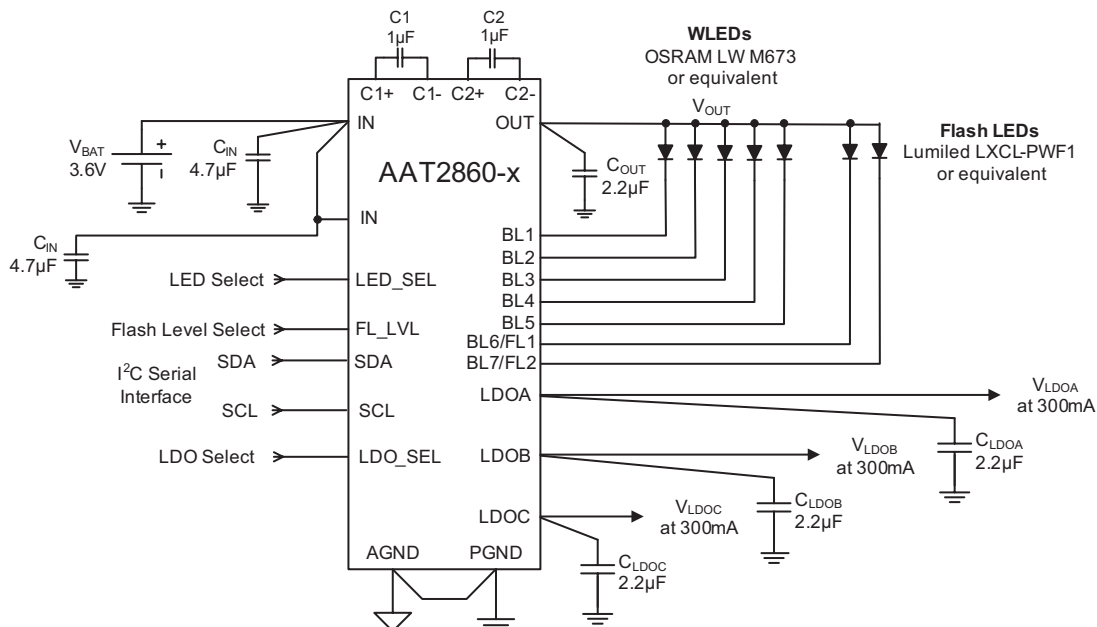

Features

- Input Voltage Range: 2.7V to 5.5V
- I²C Compatible Serial Interface
- Tri-Mode Charge Pump
 - Drives up to Seven LEDs (Backlight/Flash)
- Programmable Backlight Current Settings
 - 32 Levels - 0.5mA to 31mA
- Programmable Flash Current
 - 16 Levels - OFF to 300mA
- 1MHz Switching Frequency
- Automatic Soft-Start
- Three Low Dropout Regulators
 - 300mA Output Current
 - 150mV Dropout
 - Programmable Output from 1.5V to 3.0V
 - Output Auto-Discharge for Fast Shutdown
- Built-In Thermal Protection
- -40°C to +85°C Temperature Range
- TQFN34-24 Package

Applications

- Camera Enabled Mobile Devices
- Digital Still Cameras
- Multimedia Mobile Phones

Pin Descriptions

Pin #	Symbol	Description
1	OUT	Charge pump output. OUT is the output of the charge pump and supplies current to the backlight and flash LEDs. Connect the backlight and flash LED anodes to OUT. Bypass OUT to PGND with a 2.2μF or larger ceramic capacitor as close to the AAT2860-x as possible.
2	C2+	Positive terminal of charge pump capacitor 2. Connect the 1μF charge pump capacitor 2 from C2+ to C2-.
3	SDA	I ² C compatible serial data input. SDA is the data input of the I ² C serial interface. Drive SDA with the I ² C data.
4	SCL	I ² C compatible serial clock input. SCL is the clock input of the I ² C serial interface. Drive SCL with the I ² C clock.
5	LED_SEL	LED Programming Enable Input. When LED_SEL is strobed low-to-high, the backlight and flash LED registers can be programmed via the I ² C compatible serial interface. When LED_SEL is strobed high-to-low, all backlight and flash LED outputs are turned off and the backlight and flash LED registers are reset to their default (power-on-reset or POR) values.
6	FL_LVL (AGND)	AAT2860-2/3/4: Flash/Torch enable input. When LED_SEL is strobed high and FL_LVL is strobed high, the flash LED current outputs are enabled and set according to the contents of the flash LED current register. When FL_LVL is strobed high-to-low, the flash LED outputs return to their low-level programmed values. AAT2860-1/5: Connect to AGND.
7	LDO_SEL	Programming enable input for LDO[A, B, C]. When LDO_SEL is strobed low-to-high, the LDO output voltages can be programmed via the I ² C compatible serial interface. Strobing LDO_SEL high-to-low resets the contents of the LDO output voltage registers to their default (POR) values and forces all outputs to 0 (zero) volt.
8	AGND	Analog ground. Connect AGND to PGND at a single point as close to the AAT2860-x as possible.
9	LDOC	LDOC regulated voltage output. LDOC is the voltage output of LDOC. Bypass LDOC to AGND with a 2.2μF or larger ceramic capacitor as close to the AAT2860-x as possible.
10	LDOB	LDOB regulated voltage output. LDOB is the voltage output of LDOB. Bypass LDOB to AGND with a 2.2μF or larger ceramic capacitor as close to the AAT2860-x as possible.
11	IN	Input power pin for all three LDOs. Connect Pin 11 to Pin 23 with as short a PCB trace as practical. Bypassing this pin with a separate 4.7μF or larger ceramic capacitor will improve performance.
12	LDOA	LDOA regulated voltage output. LDOA is the voltage output of LDOA. Bypass LDOA to AGND with a 2.2μF or larger ceramic capacitor as close to the AAT2860-x as possible.
13	BL1	Backlight LED 1 current sink/channel. BL1 controls the current through backlight LED 1. Connect the cathode of backlight LED 1 to BL1. If not used, connect BL1 to OUT.
14	BL2	Backlight LED 2 current sink/channel. BL2 controls the current through backlight LED 2. Connect the cathode of backlight LED 2 to BL2. If not used, connect BL2 to OUT.
15	BL3	Backlight LED 3 current sink/channel. BL3 controls the current through backlight LED 3. Connect the cathode of backlight LED 3 to BL3. If not used, connect BL3 to OUT.
16	BL4	Backlight LED 4 current sink/channel. BL4 controls the current through backlight LED 4. Connect the cathode of backlight LED 4 to BL4. If not used, connect BL4 to OUT.
17	BL5	Backlight LED 5 current sink/channel. BL5 controls the current through backlight LED 5. Connect the cathode of backlight LED 5 to BL5. If not used, connect BL5 to OUT.
18	BL6 (FL1)	AAT2860-1/2/3/5/6: Backlight LED 6 current sink/channel. BL6 controls the current through backlight LED 6. Connect the cathode of backlight LED 6 to BL6. If not used, connect BL6 to OUT. AAT2860-4: Flash LED 1 current sink. FL1 controls the current through Flash LED 1. Connect the cathode of Flash LED 1 to FL1. If not used, connect FL1 to OUT.
19	BL7 (FL2)	AAT2860-1/5/6: Backlight LED 7 current sink/channel. BL7 controls the current through backlight LED 7. Connect the cathode of backlight LED 7 to BL7. If not used, connect BL7 to OUT. AAT2860-2/3/4: Flash LED or Flash LED 2 current sink. FL2 controls the current through Flash LED 2. Connect the cathode of Flash LED 2 to FL2. If not used, connect FL2 to OUT.
20	PGND	Power ground. Connect PGND to AGND at a single point as close to the AAT2860-x as possible.
21	C2-	Negative terminal of charge pump capacitor 2.
22	C1-	Negative terminal of charge pump capacitor 1.
23	IN	Power input. Connect IN to the input source voltage. Bypass IN to PGND with a 4.7μF or larger ceramic capacitor as close to the AAT2860-x as possible.
24	C1+	Positive terminal of charge pump capacitor 1. Connect the 1μF charge pump capacitor 1 from C1+ to C1-.
EP		Exposed paddle (bottom) Connect to PGND/AGND as close to the AAT2860-x as possible.

Pin Configuration

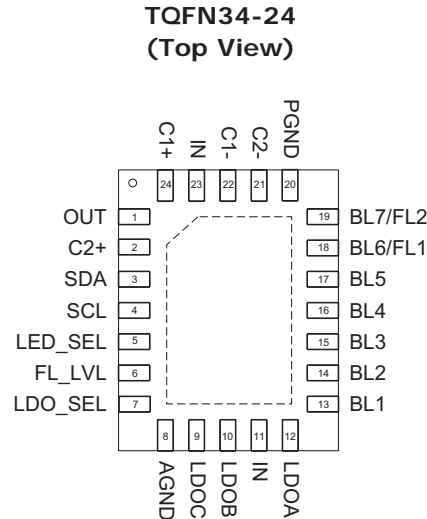

Part Number Descriptions¹

Part Number	Backlight LED Outputs		Flash LED Outputs
	Main	Sub	
AAT2860-1	7/4	0/3	0
AAT2860-2	6/4	0/2	1
AAT2860-3	6/5	0/1	1
AAT2860-4	5/4	0/1	2
AAT2860-5	7/6	0/1	0
AAT2860-6	7/5	0/2	0

Absolute Maximum Ratings²

Symbol	Description	Value	Units
	IN, OUT, BL1, BL2, BL3, BL4, BL5, BL6/FL1, BL7/FL2 Voltage to AGND	-0.3 to 6.0	V
	C1+, C2+, SDA, SCL Voltage to AGND	-0.3 to $V_{OUT} + 0.3$	V
	LDOA, LDOB, LDOC, LED_SEL, FL_LVL, LDO_LVL, C1-, C2- Voltage to AGND	-0.3 to $V_{IN} + 0.3$	V
	PGND Voltage to AGND	-0.3 to 0.3	V
T_J	Operating Junction Temperature Range	-40 to 150	°C
T_{LEAD}	Maximum Soldering Temperature (at leads, 10 sec)	300	°C

Thermal Information^{3, 4}

Symbol	Description	Value	Units
P_D	Maximum Power Dissipation	2.0	W
Θ_{JA}	Maximum Thermal Resistance	50	°C/W

- Backlight and Flash Configuration within a part number is configured through the I²C serial interface. For example, clearing the MEQS flag (set to "0") in the AAT2860-1's REG2 register will configure BL1-BL4 LED outputs as MAIN and BL5-BL7 outputs as SUB.
- Stresses above those listed in Absolute Maximum Ratings may cause permanent damage to the device. Functional operation at conditions other than the operating conditions specified is not implied. Only one Absolute Maximum Rating should be applied at any one time.
- Derate 20 mW/°C above 25°C ambient temperature.
- Mounted on a FR4 circuit board.

ChargePump™ Backlight/Flash LED Driver and Multiple LDO Lighting Management Unit
Electrical Characteristics¹

$V_{IN} = 3.6V$; $C_{IN} = 4.7\mu F$; $C_{OUT} = C_{LDO(A, B, C)} = 2.2\mu F$; $C1 = C2 = 1\mu F$; $T_A = -40^\circ C$ to $+85^\circ C$, unless otherwise noted. Typical values are $T_A = 25^\circ C$.

Symbol	Description	Conditions	Min	Typ	Max	Units
V_{IN}	IN Operating Voltage Range		2.7		5.5	V
I_{IN}	IN Operating Current	LED_SEL = IN, LDO_SEL = FL_LVL = AGND; ADDR = 02 _H , DATA = 4C _H			0.65	mA
		2X Mode; LED_SEL = IN, FL_LVL = LDO_SEL = AGND; BL1-BL7 = OPEN			5.5	mA
		2X Mode; LED_SEL = IN, FL_LVL = IN; LDO_SEL = AGND; FL1-FL2 = OPEN			5.5	mA
		LED_SEL = FL_LVL = AGND, LDO_SEL = IN; ADDR = 01 _H ; DATA = 0E _H ; No Load			220	μA
$I_{IN(SHDN)}$	IN Shutdown Current	LED_SEL, LDO_SEL, FL_LVL = AGND			1.0	μA
T_{SD}	Over-Temperature Shutdown Threshold			140		$^\circ C$
$T_{SD(HYS)}$	Over-Temperature Shutdown Hysteresis			15		$^\circ C$
Charge Pump Section						
$V_{IN(TH, H, BL)}$	BL1-BL7 Charge Pump Mode Transition Hysteresis	LED_SEL = IN, ADDR = 02 _H , DATA = 6C _H ; FL_LVL = AGND, LDO_SEL = AGND		0.15		V
$V_{IN(TH, H, FL)}$	FL1-FL2 Charge Pump Mode Transition Hysteresis			1		V
f_{OSC}	Charge Pump Oscillator Frequency	$T_A = 25^\circ C$		1		MHz
$t_{CP(SS)}$	Charge Pump Soft-start Time	$T_A = 25^\circ C$		100		μs
BL1-BL5, BL6/FL1, BL7/FL2 LED Drivers						
$t_{LED(SU)}$	LED Output Current Start-up Time	OUT: 0V to IN		20		μs
I_{BLx}	BL1-BL7 Current Accuracy	LED_SEL = IN, ADDR=02 _H , DATA=6C _H ; $V_{IN} - V_F = 1V$; FL_LVL = LDO_SEL = AGND	27	30	33	mA
$I_{BL(DAT-A7DH)}$	BL1-BL7 Current Accuracy	LED_SEL = IN, ADDR=02 _H , DATA=7D _H ; $V_{IN} - V_F = 1V$; FL_LVL = LDO_SEL = AGND	2.55	3	3.45	mA
$\frac{\Delta I_{(BLx)}}{I_{BL(AVG)}}$	BL1-BL7 Current Matching ²	LED_SEL = IN, ADDR=02 _H , DATA=6C _H ; $V_{IN} - V_F = 1V$; FL_LVL = LDO_SEL = AGND		3		%
$V_{BL(TH)}$	BL1-BL7 Charge Pump Transition Threshold	LED_SEL = IN, ADDR=02 _H , DATA=60 _H ; $V_{IN} - V_F = 1V$; FL_LVL = LDO_SEL = AGND		0.18		V
t_{FADE}	BL1-BL7 Automatic Fade Out Timer	LED_SEL = IN, ADDR=02 _H , DATA=6C _H ; $V_{IN} - V_F = 1V$; FL_LVL = LDO_SEL = AGND		1		s
$I_{FL[1/2]}$	FL1, FL2 Current Accuracy, -4 Option	LED_SEL = FL_LVL = IN, ADDR=04H, DATA=03H; $V_{IN} - V_F = 1V$, LDO_SEL = AGND	270	300	330	mA
$I_{FL[1/2]}$	FL1, FL2 Current Accuracy, -4 Option	LED_SEL = FL_LVL = IN, ADDR = 04H, DATA=60H; $V_{IN} - V_F = 1V$, LDO_SEL = AGND	54	60	66	mA
I_{FL2}	FL2 Current Accuracy, -2 and -3 Options	LED_SEL = FL_LVL = IN, ADDR = 04H, DATA=03H; $V_{IN} - V_F = 1V$, LDO_SEL = AGND	540	600	660	mA
I_{FL2}	FL2 Current Accuracy, -2 and -3 Options	LED_SEL = FL_LVL = IN, ADDR = 04H, DATA=60H; $V_{IN} - V_F = 1V$, LDO_SEL = AGND	108	120	132	mA

1. The AAT2860 is guaranteed to meet performance specifications over the $-40^\circ C$ to $+85^\circ C$ operating temperature range and is assured by design, characterization, and correlation with statistical process controls.
 2. Current matching is defined as the deviation of any sink/channel current from the average of all active channels.

ChargePump™ Backlight/Flash LED Driver and Multiple LDO Lighting Management Unit
Electrical Characteristics¹

$V_{IN} = 3.6V$; $C_{IN} = 4.7\mu F$; $C_{OUT} = C_{LDO(A, B, C)} = 2.2\mu F$; $C1 = C2 = 1\mu F$; $T_A = -40^\circ C$ to $+85^\circ C$, unless otherwise noted. Typical values are $T_A = 25^\circ C$.

Symbol	Description	Conditions	Min	Typ	Max	Units
LDO Regulators						
$\frac{\Delta V_{LDO[A/B/C]}}{V_{LDO[A/B/C]}}$	LDOA, LDOB, LDOC Output Voltage Tolerance	$I_{LDO} = 1mA$ to $300mA$; $T_A = 25^\circ C$	-1.5		+1.5	%
		$I_{LDO} = 1mA$ to $300mA$; $T_A = -40^\circ C$ to $+85^\circ C$	-3		+3	%
$I_{LDO[A/B/C](MAX)}$	LDOA, LDOB, LDOC Maximum Load Current		300			mA
$V_{LDO[A/B/C](DO)}$	LDOA, LDOB, LDOC Dropout Voltage ²	$V_{LDO[A/B/C]} \geq 2.7V$; $I_{LDO} = 150mA$		75	150	mV
$\frac{\Delta V_{LDO}}{V_{LDO} * \Delta V_{IN}}$	Line Regulation	$V_{IN} = (V_{LDO[A/B/C]} + 1V)$ to $5V$		0.09		%/V
$PSRR_{[A/B/C]}$	LDOA, LDOB, LDOC Power Supply Rejection Ratio	$I_{LDO[A/B/C]} = 10mA$, 1kHz		40		dB
R_{LDO_DCHG}	LDOA, LDOB, LDOC Auto-Discharge Resistance			20		Ω
I²C Logic and Control Interface						
V_{IL}	SDA, SCL, LED_SEL, FL_LVL, LDO_SEL Input Low Threshold	$2.7V \leq V_{IN} \leq 5.5V$		0.4		V
V_{IH}	SDA, SCL, LED_SEL, FL_LVL, LDO_SEL Input High Threshold	$2.7V \leq V_{IN} \leq 5.5V$	1.4			V
I_{IN}	SDA, SCL, LED_SEL, FL_LVL, LDO_SEL Input Leakage Current	SDA = SCL = LED_SEL = FL_LVL = LDO_SEL = 5V	-1		1	μA
f_{SCL}	SCL Clock Frequency		0		400	kHz
t_{LOW}	SCL Clock Low Period		1.3			μs
t_{HIGH}	SCL Clock High Period		0.6			μs
t_{HD_STA}	Hold Time START Condition		0.6			μs
t_{SU_STA}	Setup Time for Repeat START		0.6			μs
t_{SU_DAT}	SDA Data Setup Time		500			ns
t_{HD_DAT}	SDA Data HOLD Time		0.5			μs
t_{SU_STO}	Setup Time for STOP Condition		0.6			μs
t_{BUF}	Bus Free Time Between STOP and START Conditions		1.3			μs

1. The AAT2860 is guaranteed to meet performance specifications over the $-40^\circ C$ to $+85^\circ C$ operating temperature range and is assured by design, characterization, and correlation with statistical process controls.

2. $V_{DO[A/B/C]}$ is defined as $V_{IN} - V_{LDO[A/B/C]}$ when $V_{LDO[A/B/C]}$ is 98% of nominal.

I²C Compatible Interface Timing Details

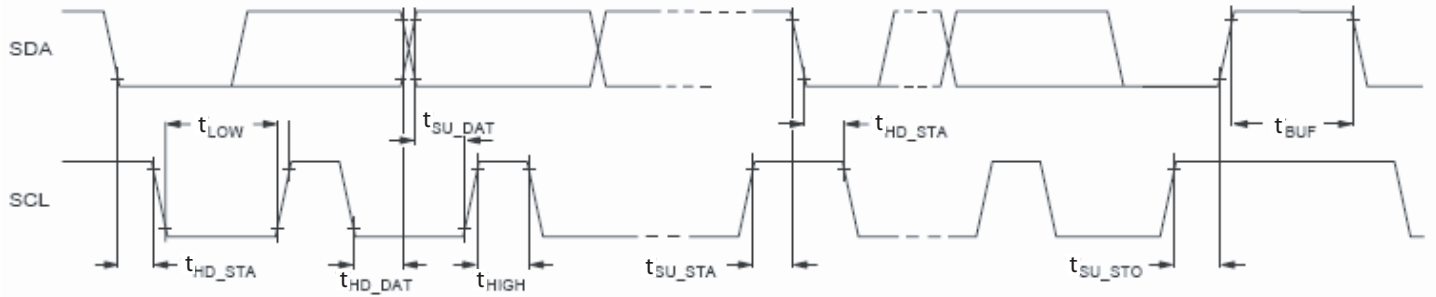

Typical Characteristics

Backlight Mode Efficiency vs. Input Voltage

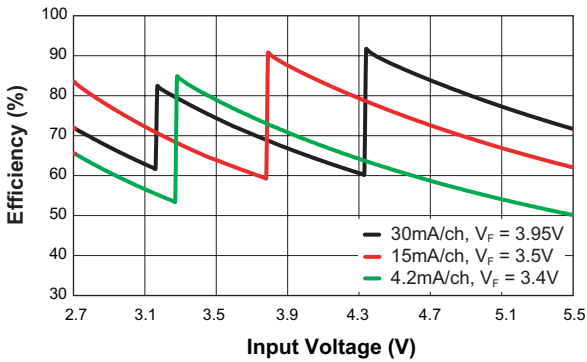

Flash Efficiency vs. Input Voltage

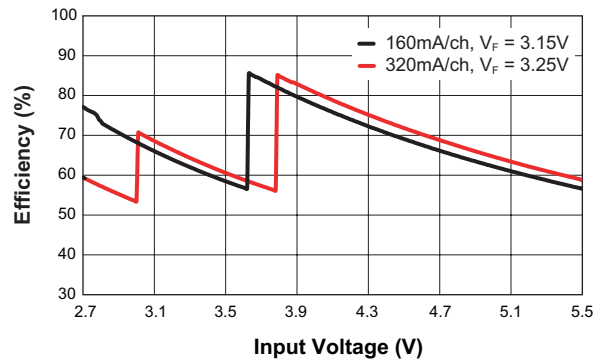

Backlight Current Matching vs. Temperature
($V_{IN} = 3.6V$; 30mA/Channel)

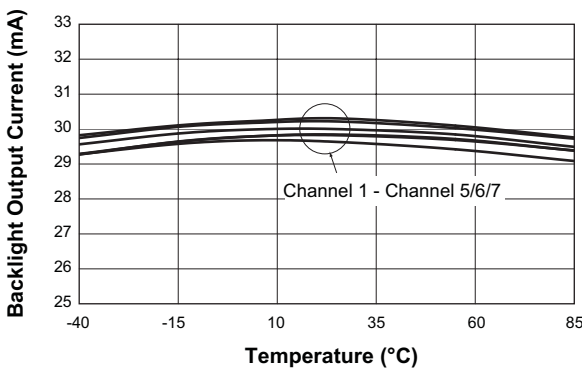

Charge Pump Output Turn-On Characteristic
($V_{IN} = 3.6V$; 0mA/Channel; $C_{OUT} = 2.2V$)

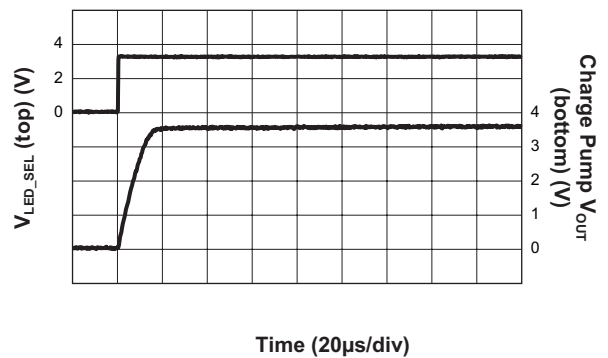

Flash Mode Turn-On Characteristic
($V_{IN} = 4.2V$; 300mA/Channel; 1x Mode)

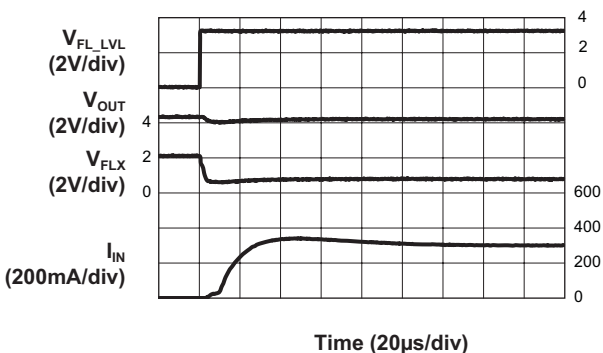

Flash Mode Turn-On Characteristic
($V_{IN} = 3.6V$; 300mA/Channel; 1.5x Mode)

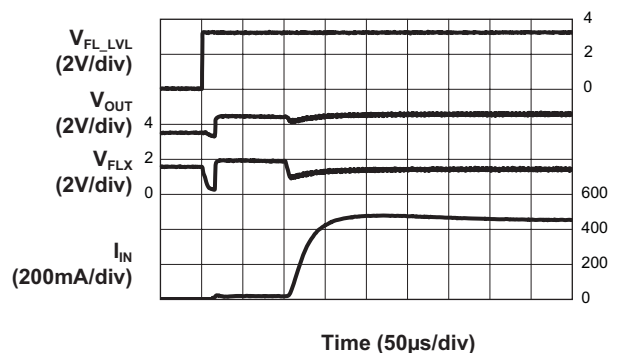

Typical Characteristics

Flash Mode Turn-On Characteristic
($V_{IN} = 2.8V$; 300mA/Channel; 2x Mode)

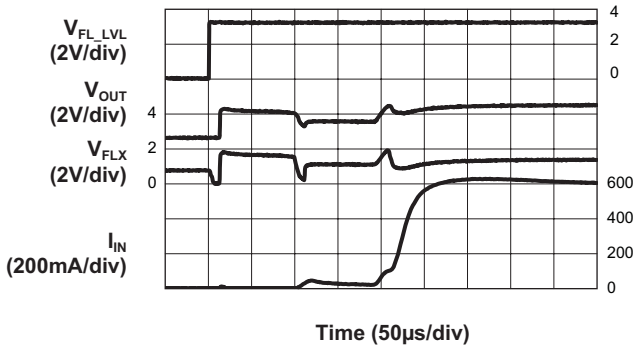

Backlight Mode Turn-On Characteristic
($V_{IN} = 4.6V$; 30mA/Channel; 1x Mode)

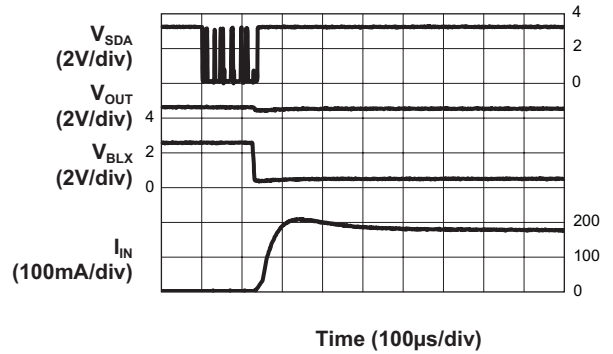

Backlight Mode Turn-On Characteristic
($V_{IN} = 3.6V$; 30mA/Channel; 1.5x Mode)

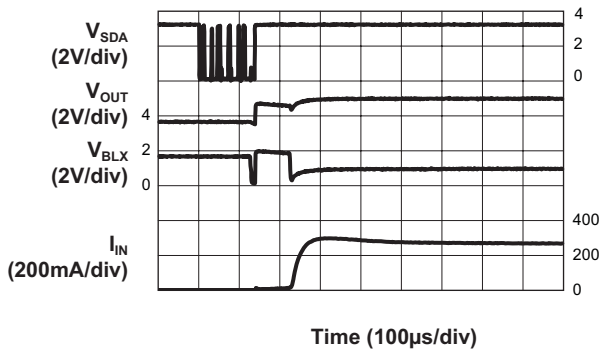

Backlight Mode Turn-On Characteristic
($V_{IN} = 3.2V$; 30mA/Channel; 2x Mode)

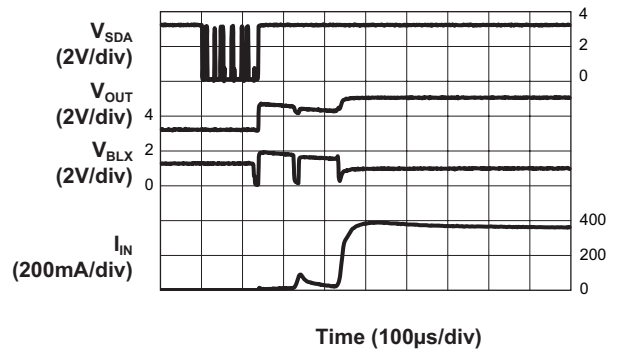

Backlight Mode Turn-Off Characteristic
($V_{IN} = 3.6V$; 30mA/Channel; 1.5x Mode)

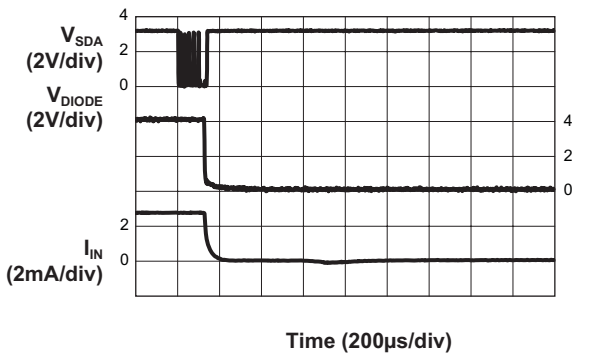

Operating Characteristic
(30mA/Channel Backlight; 1.5x Mode; $V_{IN} = 3.6V$; $C_{OUT} = 2.2\mu F$)

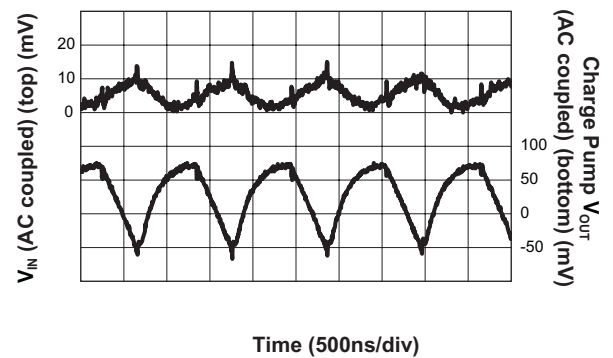

Typical Characteristics

Operating Characteristic

(30mA/Channel Backlight; 2x Mode; $V_{IN} = 3.2V$; $C_{OUT} = 2.2\mu F$)

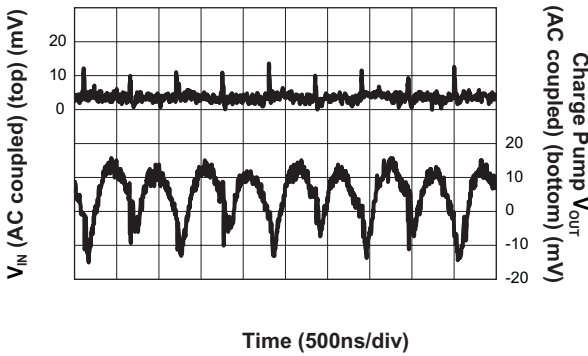

LDOs A/B/C Load Regulation

($V_{IN} = 3.6V$)

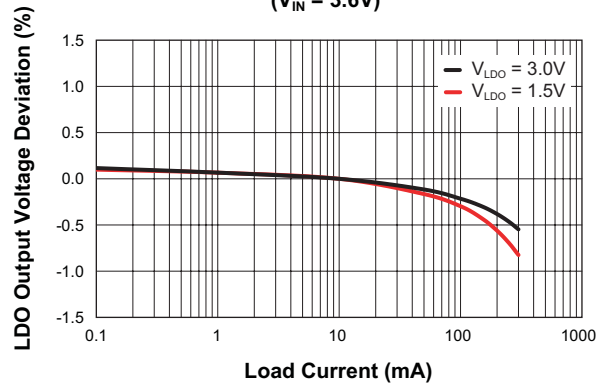

LDO Output Voltage vs Temperature

($V_{IN} = 3.6V$; $I_{LDO} = 0mA$)

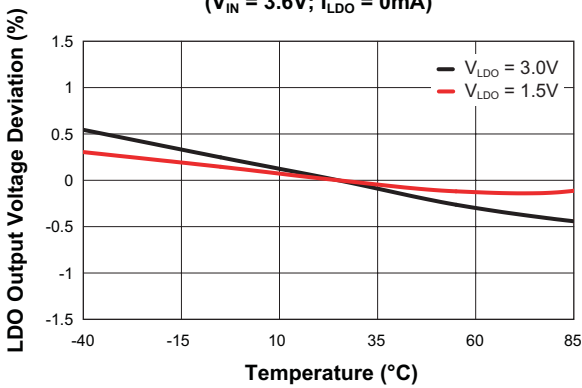

LDOs A/B/C Line Regulation

($I_{LDO} = 10mA$)

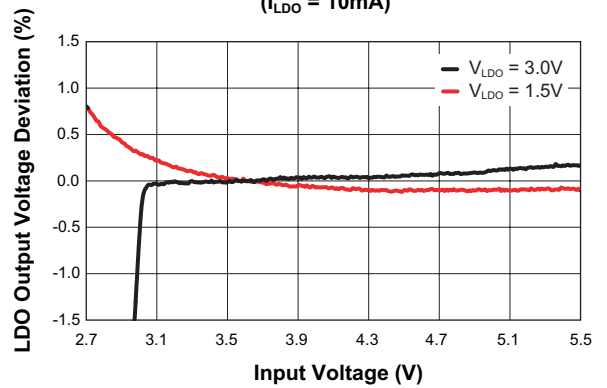

LDOs A/B/C Load Transient Response

($I_{LDO} = 10mA$ to 200mA; $V_{IN} = 3.6V$; $V_{LDO} = 1.8V$; $C_{LDO} = 2.2\mu F$)

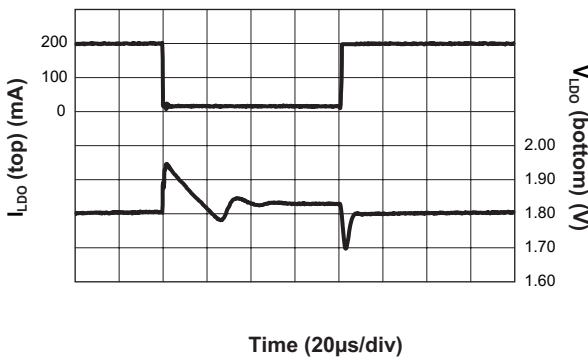

LDOs A/B/C Line Transient Response

($V_{IN} = 3.6V$ to 4.2V; $I_{LDO} = 10mA$; $V_{LDO} = 1.8V$; $C_{LDO} = 2.2\mu F$)

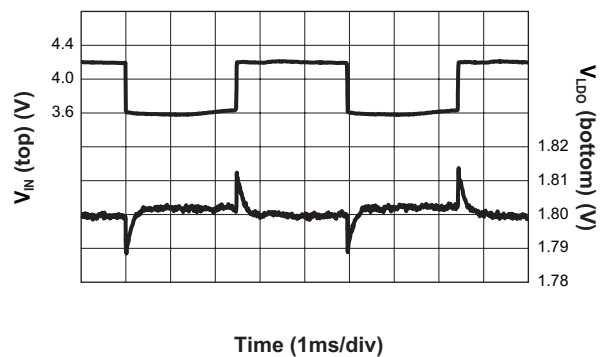

Typical Characteristics

LDOs A/B/C Turn-On Characteristic
 ($V_{LDO} = 3.0V$; $V_{IN} = 3.6V$; $C_{LDO} = 2.2\mu F$)

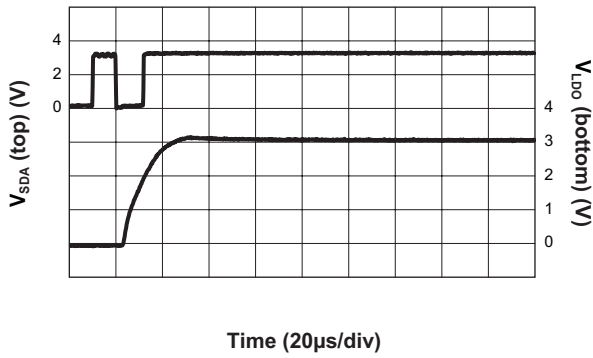

LDOs A/B/C Turn-On Characteristic
 ($V_{LDO} = 1.5V$; $V_{IN} = 3.6V$; $C_{LDO} = 2.2\mu F$)

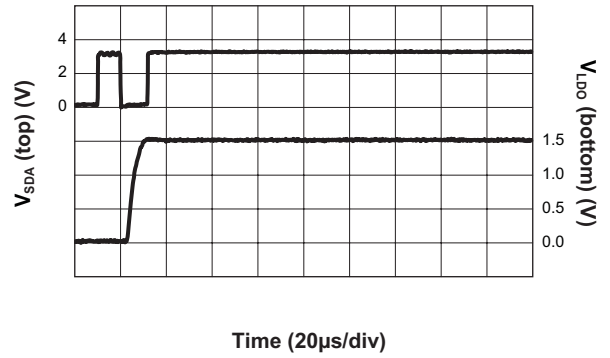

Functional Block Diagram

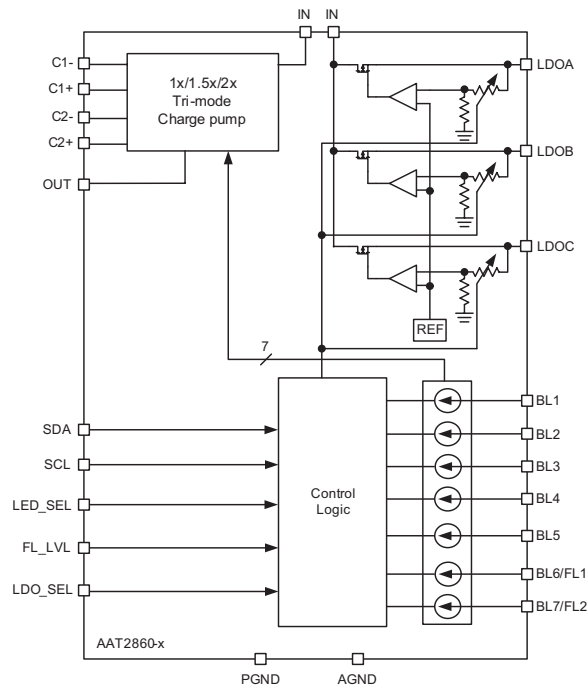

Functional Description

The AAT2860-x is a highly integrated backlight and photo-flash driver with three LDO regulators. The charge pump LED driver powers the backlight and flash LEDs from the 2.7V to 5.5V input voltage. The LDO regulators get their power from the same input and produce regulated output voltage between 1.5V and 3.0V. Control of the LEDs and the LDO output voltage is through an I²C compatible serial interface for easy programming.

LED Drivers

The AAT2860-x drives up to seven backlight LEDs up to 31mA each and up to two flash LEDs up to 300mA each. The LEDs are driven from a charge pump to insure that constant current is maintained over the entire battery voltage range. The charge pump automatically switches from 1x, 1.5x, and 2x modes and back to maintain the LED current while minimizing power loss for high efficiency. The charge pump operates at the high 1MHz switching frequency allowing the use of small 1µF ceramic fly capacitors.

The charge pump is controlled by the voltage across the LED current sinks. When any one of the active backlight current sink/channel voltages drops below 180mV

or the flash current sink/channel drops below 450mV, the charge pump goes to the next higher mode (from 1x to 1.5x or from 1.5x to 2x mode) to maintain sufficient LED voltage for constant LED current. The AAT2860-x continuously monitors the LED forward voltages and uses the input voltage to determine when to reduce the charge pump mode for better efficiency. There is also a 150mV mode-transition hysteresis that prevents the charge pump from oscillating between modes.

LED Current Control

Both the backlight and flash LED currents are controlled through an I²C compatible serial interface. The backlight LED current can be set between 0.5mA and 31mA in 1mA steps while the flash LED current can be set between 0mA and 300mA in 20mA steps. The backlight LED currents match to within 3% while the flash LED currents match to within 5%.

To eliminate the latency of the I²C compatible serial interface, the flash LED is enabled through a dedicated input, FL_LVL. The AAT2860-x also include a safety timer that prevents overstress of the flash LED(s). This is important because many flash LEDs operate for a brief period beyond their steady-state operating limitations. If the flash driving hardware and/or software fails to turn

ChargePump™ Backlight/Flash LED Driver and Multiple LDO Lighting Management Unit

the LED off, the safety timer insures that the LED or other circuitry is not damaged.

Both the backlight and flash LED currents are programmed through the I²C compatible serial interface as are the backlight fade timer, the flash safety timer, and the torch/flash inhibit current levels. See the "I²C Compatible Serial Interface" section of this datasheet for more information on setting the LED currents. To enable the flash LED(s), strobe both LED_SEL and FL_LVL inputs low-to-high. As long as FL_LVL signal is held high, the flash LED remains on unless it is on longer than the safety timer period. If this occurs, the flash LED is turned off.

LDO Regulators

The AAT2860-x family include three LDO regulators. These regulators are powered from the battery and produce a fixed output voltage set through the I²C compatible serial interface. The output voltage can be set to one of 16 output voltages between 1.5V and 3.0V. The LDOs can also be turned on/off through the I²C compatible serial interface.

The LDO regulators require only a small 2.2μF ceramic output capacitor for stability. If improved load transient response is required, larger-valued capacitors can be used without stability degradation.

I²C Compatible Serial Interface

The AAT2860-x uses an I²C serial interface to set the LED currents, the flash timer period, the LDO on/off and output voltage, as well as other housekeeping functions. The I²C interface takes input from a master device while the AAT2860-x acts as a target to the master. The I²C protocol uses two open-drain inputs; SDA (serial data line) and SCL (serial clock line). Both inputs require an external pull up resistor, typically to the input voltage. The I²C protocol is bidirectional and allows target devices and masters to both read and write to the bus. AAT2860 only supports the write protocol and therefore the Read/Write bit must

always be set to "0". The timing diagram in Figure 1 below shows the typical transmission protocol.

I²C Compatible Serial Interface Protocol

The I²C compatible serial interface protocol is shown in Figure 1. Devices on the bus can be either master or target devices. Both master and target devices can both send and receive data over the bus, with the difference being that the master device controls all communication on the bus. The AAT2860-x acts as a target device on the bus and is only capable of receiving data and does not transmit data over the bus.

The I²C communications begin with the master generating a START condition. Next, the master transmits the 7-bit device address and a read/write bit. Each target device on the bus has a unique address. If the address transmitted by the master matches the device address, the target device transmits an acknowledge (ACK) signal to indicate that it is ready to receive data. Since the AAT2860-x only reads from the master, the read/write bit must be set to "0". Next, the master transmits an 8-bit register address, and the target device transmits an ACK to indicate that it has received the register address. Next, the master transmits an 8-bit data word, and again the target device transmits an ACK indicating that it has received the data. This process continues until the master is finished writing to the target device at which time the master generates a STOP condition.

START and STOP Conditions

START and STOP conditions are always generated by the master. Prior to initiating a START, both the SDA and SCL pin are active. As shown in Figure 2, a START condition is when the master pulls the SDA line low and, after the START condition hold time (t_{HD_STA}), the master strobes the SCL line low. A START condition acts as a signal to devices on the bus that the device producing the START condition is active and will be communicating on the bus.

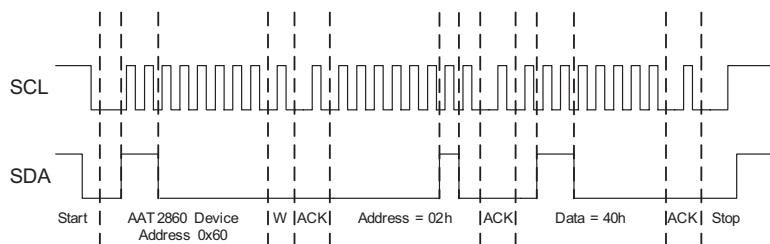

Figure 1: Typical I²C Timing Diagram.

ChargePump™ Backlight/Flash LED Driver and Multiple LDO Lighting Management Unit

A STOP condition, as shown in Figure 2, is when SCL changes from low to high followed after the STOP condition setup time (t_{SU_STO}), by the SDA low-to-high transition. The master does not issue an ACK and releases both the SCL and SDA line.

Transferring Data

Addresses and data are sent with the most significant bit transmitted first and the least significant bit transmitted last. After each address or data transmission, the target device transmits an ACK signal to indicate that it has received the transmission. The ACK signal is generated by the target after the master releases the SDA data line by driving the SDA data line low.

I²C Serial Programming Registers

The AAT2860's I²C programming registers are listed in Table 1. There are six registers, two for backlight LED configuration/control, one for flash/lamp LED configuration/control, and two registers to control the three LDOs. For the remainder of this document the superscript "1"

signifies the power on reset (POR) value of a register, the superscript "2" signifies the default value of "1" for a particular bit of a register, and the superscript "3" signifies "Don't Care" or "Reserved."

LDO Control Registers, REG0 and REG1

Configuring and controlling the AAT2860-x's three LDO regulators is performed by applying a low-to-high strobe on the LDO_SEL pin and then programming registers REG0 and REG1 over the I²C compatible interface. Two 4-bit nibbles in REG0 set the output voltages for LDOA and LDOB to one of 16 levels. In REG1, the most-significant nibble programs LDOC's output voltage while the least-significant 4-bit nibble controls each LDO's ON/OFF status. Upon power-on reset (POR), all three LDO outputs are held to 0V or AGND. The programmed LDO output voltage will only appear after writing a "1" to each or all REG1[D3:D1] locations. If a high-to-low transition is applied to the LDO_SEL pin, all three LDO outputs are forced to 0V and the register contents are reset to their POR values. The available LDO output voltages are shown in Table 2.

	D7	D6	D5	D4	D3	D2	D1	D0
REG0	LDOA[3]	LDOA[2]	LDOA[1]	LDOA[0]	LDOB[3]	LDOB[2]	LDOB[1]	LDOB[0]
REG1	LDOC[3]	LDOC[2]	LDOC[1]	LDOC[0]	ENLDO_C	ENLDO_B	ENLDO_A	X ³
REG2	X ³	MEQS ²	MAIN_ON	WM[4]	WM[3]	WM[2]	WM[1]	WM[0]
REG3	FLOOR[1]	FLOOR[0]	SUB_ON	WS[4]	WS[3]	WS[2]	WS[1]	WS[0]
REG4	F_HI[3] ²	F_HI[2] ²	F_HI[1]	F_HI[0]	F_TIME[1]	F_TIME[0]	F_LO[1] ²	F_LO[0] ²
REG5	X ³	X ³	X ³	X ³	X ³	X ³	NOFADE_M ²	NOFADE_S ²

Table 1: AAT2860-x Configuration/Control Register Allocation.

LDOx[4:0]	LDO V _{OUT} [A/B/C] (V)	LDOx[4:0]	LDO V _{OUT} [A/B/C] (V)
0000 ¹	1.5 ¹	1000	2.3
0001	1.6	1001	2.4
0010	1.7	1010	2.5
0011	1.8	1011	2.6
0100	1.9	1100	2.7
0101	2.0	1101	2.8
0110	2.1	1110	2.9
0111	2.2	1111	3.0

Table 2: LDO[A:C] Output Voltage Control Data

1. Denotes the default (power-on-reset) value.
2. Denotes default value is "1" or ON.
3. Don't Care or Reserved.



Figure 2: I²C STOP and START Conditions.

START: A High “1” to Low “0” Transition on the SDA Line While SCL is High “1”
STOP: A Low “0” to High “1” Transition on the SDA Line While SCL is High “1”

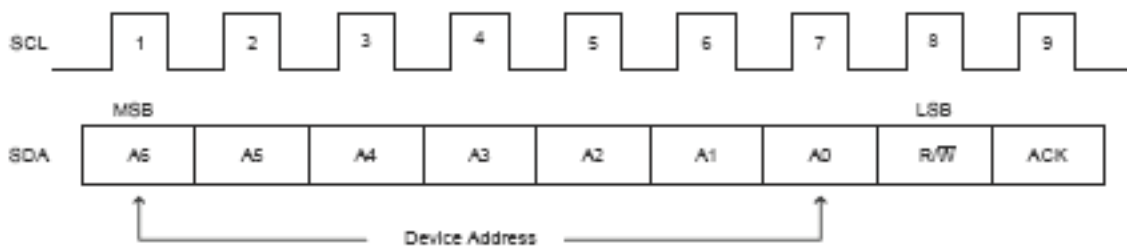

Figure 3: I²C Address Bit;

7-bit Slave Address (A6-A0), 1-bit Read/Write (R/W), 1-bit Acknowledge (ACK).

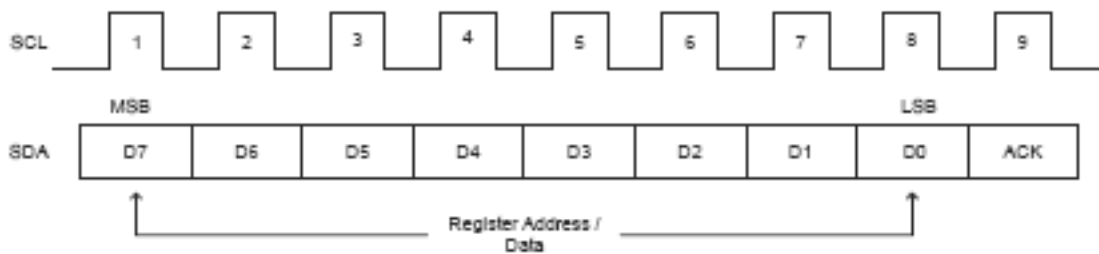

Figure 4: I²C Register Address and Data Bit Map;

8-bit Data (D7-D0), 1-bit Acknowledge (ACK).

BL1-BL7 Backlight Control Registers, REG2, REG3, and REG5

The AAT2860-x's I²C registers REG2 and REG3 control the backlight LED configuration and output current level in each group of outputs. REG2[D6] (MEQS) defines whether all seven LED outputs are controlled as a single group (MEQS = 1 = POR default setting) or are divided into two sets (by writing a "0" into REG2[D6]) for MAIN/SUB display applications according to the "Part Number Descriptions" table.

The default condition for all backlight outputs (BL1-BL5/BL6/BL7) is OFF after power-up. If the BL1-BL5/BL6/BL7 outputs are grouped together, REG2 Data Bit 5 (MAIN_ON) is the ON/OFF control for the group; in this case, REG3[D5] (SUB_ON register bit) is ignored. In the case of the AAT2860-1, setting MEQS = 0 after POR groups the BL1-BL4 outputs together as MAIN and groups the BL5-BL7 outputs as SUB. In this case, REG2[D5] is the ON/OFF control for the MAIN group and REG3[D5] is the ON/OFF control for the SUB group.

The AAT2860-x LMU also provides an internal LED current fade function. Fade functionality simply allows for the turning on/off of the LEDs in a smooth controlled transition. The AAT2860 does not have to be manually programmed to avoid the abrupt changes in lighting when white LED drivers are tuned-on and/or turned-off. The fade-in/fade-out operation occurs only during LED on/off transitions. The fade response time is constant regardless of the LED current level. This feature is useful in those applications where turning ON/OFF the backlight current using a smooth transition versus an abrupt ON-to-OFF transition is preferred. If MEQS = 1 (REG2[D6]), then fade will be disabled in all LED's when NO_FADE_M (REG5[D1]) is written to 1. In this case, the contents of NO_FADE_S (REG5[D0]) are ignored. If MEQS = 0, then fade can be disabled independently for the MAIN and SUB LED groups using the bits NO_FADE_M and NO_FADE_S.

Based on the programmed LED current level set by WM[4:0] (REG2[D4:D0]) and/or WS[4:0] (REG3[D4:D0]), the AAT2860-x increases/decreases linearly from/to the programmed FLOOR (REG3[D7:D6]) level to/from the current level set for the MAIN (REG2[D4:D0]) and SUB (REG3[D4:D0]) groups during LED ON/OFF transitions. The AAT2860-x's internal fade response time is approximately 1 second. In addition, the AAT2860-x provides four settings selectable over the I²C interface for the fade function's LED current floor and these settings are illustrated in Table 5.

FL1-FL2 Flash Driver Control Register REG4

Metal-mask options of the base AAT2860-x design have been configured for backlight and flash/torch applications. As shown in the "Part Number Descriptions" table, there are three combinations for backlight and flash available in this family: the AAT2860-2 (6M+0S+1FL or 4M+2S+1FL), the AAT2860-3 (6M+0S+1FL or 5M+1S+1FL), or the AAT2860-4 (5M+0S+2FL or 4M+1S+2FL). The configuration of the LED outputs is controlled by the MEQS bit. In all cases, the MEQS POR default value of "1" or a user-programmed value of "0" selects the configuration of the AAT2860-2/3/4 according to Table 6.

In all options, the BLX current outputs can be programmed as a single unit (MEQS = 1) or configured in a MAIN/SUB arrangement with separate current levels between MAIN and SUB (MEQS = 0). In the case of the AAT2860-2/3 options where the MEQS bit has been programmed as a "0," the BL7 LED output is internally re-configured as a single flash/lamp current output, FL. In these options, the maximum available current from the flash output is 600mA (see Table 7) and maximum available current for torch or flash inhibit is 120mA (see Table 9). For the AAT2860-4, the BL6 and the BL7 outputs are internally reconfigured as flash current outputs, FL1 and FL2, respectively, where each flash output is capable of supplying up to 300mA in full-flash mode and up to 60mA in torch mode.

	D7	D6	D5	D4	D3	D2	D1	D0
REG2	X ³	MEQS ²	MAIN_ON	WM[4]	WM[3]	WM[2]	WM[1]	WM[0]
REG3	FLOOR[1]	FLOOR[0]	SUB_ON	WS[4]	WS[3]	WS[2]	WS[1]	WS[0]
REG5	X ³	X ³	X ³	X ³	X ³	X ³	NOFADE_M ²	NOFADE_S ²

Table 3: AAT2860 BL1-BLX Backlight Control Register Allocation.

WM[4:0], WS[4:0]	LED Current (mA)	WM[4:0], WS[4:0]	LED Current (mA)
00000 ¹	31 ¹	10000	15
00001	30	10001	14
00010	29	10010	13
00011	28	10011	12
00100	27	10100	11
00101	26	10101	10
00110	25	10110	9
00111	24	10111	8
01000	23	11000	7
01001	22	11001	6
01010	21	11010	5
01011	20	11011	4
01100	19	11100	3
01101	18	11101	2
01110	17	11110	1
01111	16	11111	0.5

Table 4: MAIN/SUB LED Current - WM/WS[4:0].

FLOOR[1:0]	Fade In/Out Current Level (mA)
00 ¹	0.48
01	0.97
10	1.94
11	2.90

Table 5: Main/Sub LED Current Fade In/Out Level Control.

Part Number	MEQS Bit (REG2 Data Bit[6])	
	"1" (Default)	"0"
AAT2860-2	6M+0S+1FL	4M+2S+1FL
AAT2860-3	6M+0S+1FL	5M+1S+1FL
AAT2860-4	5M+0S+2FL	4M+1S+2FL

Table 6: AAT2860-2/3/4 Flash Driver Control Register Allocation.

For each one of the three options in Table 6, setting/programming the bits in REG4 (see Table 7) sets the full-scale flash current, the torch current levels, and flash safety time duration. The most-significant 4-bit nibble (REG1[D7:D4], or F_HI[3:0]) of the 8-bit data word sets the full-scale flash LED current, the middle two bits (REG4[D3:D2], or F_TIME[1:0]) set the flash safety duration, and the last two bits (REG4[D1:D0], or F_LO[1:0]) are used to set the torch current level.

1. Denotes default (power-on-reset) value.
 2. Denotes default value is "1" or ON.
 3. Don't Care or Reserved.

	D7	D6	D5	D4	D3	D2	D1	D0
REG4	F_HI[3] ²	F_HI[2] ²	F_HI[1]	F_HI[0]	F_TIME[1]	F_TIME[0]	F_LO[1] ²	F_LO[0] ²

Table 7: AAT2860-x Flash/Torch Control Register Allocation.

F_HI[3:0]	Flash Current (mA) per Output	
	AAT2860-2 or -3	AAT2860-4
0000	600	300
0001	560	280
0010	520	260
0011	480	240
0100	440	220
0101	400	200
0110	360	180
0111	320	160
1000	280	140
1001	240	120
1010	200	100
1011	160	80
1100 ¹	120 ¹	60 ¹
1101	80	40
1110	40	20
1111	OFF	OFF

Table 8: Flash LED Current Register, F_HI[3:0].

F_TIME[1:0]	Flash Time (sec)
00 ¹	2 ¹
01	1
10	0.5
11	Always ON

Table 9: Flash Safety Timer Data, F_TIME[1:0].

F_LO[1:0]	Total Output Torch Current (mA)	
	AAT2860-2 or -3	AAT2860-4
00	120	60
01	80	40
10	40	20
11 ¹	0 ¹	0 ¹

Table 10: Torch Data, F_LO[1:0].

Applications Information

LED Selection

The AAT2860-x is specifically intended for driving white LEDs. However, the device design will allow the AAT2860-x to drive most types of LEDs with forward voltage specifications ranging from 2.0V to 4.7V. LED applications may include mixed arrangements for display backlighting, color (RGB) LEDs, infrared (IR) diodes and any other load needing a constant current source generated from a varying input voltage. Since the BL1 to BL5/BL6(FL1)/BL7(FL2) constant current sinks/channels are matched with negligible voltage dependence, the constant current channels will be matched regardless of the specific LED forward voltage (V_F) levels.

The current sinks/channels in the AAT2860-x maximize performance and make it capable of driving LEDs with high forward voltages. Multiple channels can be combined to obtain a higher LED drive current without complication.

Device Switching Noise Performance

The AAT2860-x operates at a frequency of approximately 1MHz to control noise and limit harmonics that can interfere with the RF operation of cellular telephone handsets or other communication devices. The AAT2860-x soft-start feature prevents noise transient effects associated with in-rush currents during the start up of the charge pump circuit.

Power Efficiency and Device Evaluation

Charge-pump efficiency discussion in the following sections accounts only for the efficiency of the charge pump section itself. Due to the unique circuit architecture and design of the AAT2860-x, it is very difficult to measure efficiency in terms of a percent value comparing input power over output power.

1. Denotes the default (power-on-reset) value.
2. Denotes default value is "1" or ON.

ChargePump™ Backlight/Flash LED Driver and Multiple LDO Lighting Management Unit

Since the AAT2860-x outputs are pure constant current sinks and typically drive individual loads, it is difficult to measure the output voltage for a given output (BL1 to BL5, BL6/FL1, and BL7/FL2) to derive an overall output power measurement. For any given application, white LED forward voltage levels can differ, yet the output drive current will be maintained as a constant.

This makes quantifying output power a difficult task when taken in the context of comparing to other white LED driver circuit topologies. A better way to quantify total device efficiency is to observe the total input power to the device for a given LED current drive level. The *best* White LED driver for a given application should be based on trade-offs of size, external component count, reliability, operating range and total energy usage...*Not just "% efficiency"*.

The AAT2860-x efficiency may be quantified under very specific conditions and is dependent upon the input voltage versus the output voltage seen across the loads applied to outputs BL1 through BL5, BL6(FL1), and BL7(FL2) for a given constant current setting. Depending on the combination of V_{IN} and voltages sensed at the current sinks/channels, the device will operate in "Load Switch" mode. When any one of the voltages sensed at the current sinks/channels nears dropout the device will operate in 1.5x or 2x charge pump mode. Each of these modes will yield different efficiency values. One should refer to the following two sections for explanations for each operational mode.

Device Power Efficiency

The AAT2860's charge pump conversion efficiency is defined as the power delivered to the white LED load divided by the input power:

$$\eta = \frac{P_{LEDs}}{P_{IN}} = \frac{V_{LED1} \cdot I_{LED1} + \dots + V_{LEDX} \cdot I_{LEDX}}{V_{IN} \cdot I_{IN}}$$

V_{LEDx} = White LED Forward Voltage (V_f)

I_{LEDx} = White LED Bias Current (I_D)

X = Number of White LEDs

The expression to define the estimated ideal efficiency (η) for the AAT2860 in 1x mode is as follows:

$$\eta = \frac{P_{LEDs}}{P_{IN}} = \frac{V_{LED1} \cdot I_{LED1} + \dots + V_{LEDX} \cdot I_{LEDX}}{V_{IN} \cdot I_{IN}}$$

$$\eta = \frac{X \cdot V_{LEDX} \cdot I_{LEDX}}{V_{IN} \cdot I_{IN}}; X = 1, 2, 3, \dots, 6 \text{ or } 7 \text{ and } I_{IN} = X \cdot I_{LEDX}$$

$$\eta = \frac{V_{LEDX}}{V_{IN}}$$

The AAT2860's charge pump is a fractional charge pump which will boost the input supply voltage in the event where V_{IN} is less than the required output voltage across the backlight white LED load. The efficiency can be simply defined as a linear voltage regulator with an effective backlight white LED forward voltage that is equal to one and a half (1.5x mode) times the input voltage.

With an ideal 1.5x charge pump, the input current is 1.5x of the output current. The expression to define the estimated ideal efficiency (η) for the AAT2860 in 1.5x mode is as follows:

$$\eta = \frac{P_{LEDs}}{P_{IN}} = \frac{V_{LED1} \cdot I_{LED1} + \dots + V_{LEDX} \cdot I_{LEDX}}{V_{IN} \cdot I_{IN}}$$

$$\eta = \frac{X \cdot V_{LEDX} \cdot I_{LEDX}}{V_{IN} \cdot I_{IN}}; X = 1, 2, 3, \dots, 6 \text{ or } 7 \text{ and } I_{IN} = 1.5(X \cdot I_{LEDX})$$

$$\eta = \frac{V_{LEDX}}{1.5V_{IN}}$$

The same calculations apply for the AAT2860 in 2x mode where for an ideal 2x charge pump, the input current is 2x of the output current. The expression for the estimated ideal efficiency (η) for the AAT2860 in 2x mode is as follows:

$$\eta = \frac{P_{LEDs}}{P_{IN}} = \frac{V_{LED1} \cdot I_{LED1} + V_{LED2} \cdot I_{LED2}}{V_{IN} \cdot I_{IN}}$$

$$\eta = \frac{X \cdot V_{LEDX} \cdot I_{LEDX}}{V_{IN} \cdot I_{IN}}; X = 1, 2, 3, \dots, 6 \text{ or } 7 \text{ and } I_{IN} = 2(X \cdot I_{LEDX})$$

$$\eta = \frac{V_{LEDX}}{2V_{IN}}$$

Capacitor Selection

Careful selection of the eight external capacitors C_{IN} , C1, C2, $C_{LDO(A/B/C)}$, and C_{OUT} are important because they will affect turn on time, output ripple and transient performance. Optimum performance will be obtained when low ESR ($<100m\Omega$) ceramic capacitors are used. In general, low ESR is defined as a resistance that is less than $100m\Omega$.

X7R and X5R type ceramic capacitors are highly recommended over all other types of capacitors for use with the AAT2860. For the charge pump section, a $1\mu F$ or greater capacitor is required for the fly (C1 and C2) capacitors. The three LDOs require a $2.2\mu F$ or greater output capacitor. The required input capacitor (C_{IN}) is $4.7\mu F$ or greater and the required output capacitor (C_{OUT}) is $2.2\mu F$ or greater.

Ceramic capacitors offer many advantages over their tantalum and aluminum electrolytic counterparts. A ceramic capacitor typically has very low ESR, is lowest cost, has a smaller printed circuit board (PCB) footprint, and is non-polarized. Low ESR ceramic capacitors maximize charge pump transient response.

Before choosing a particular capacitor, verify the capacitor's performance with the characteristics illustrated in the component's data sheet. Performance verification will help avoid undesirable component related performance deficiencies. Suggested typical ceramic capacitor components for the AAT2860 are listed in Table 11.

PCB Layout

To achieve adequate electrical and thermal performance, careful attention must be given to the PCB layout. In the worst-case operating condition, the chip must dissipate considerable power at full load. Adequate heat-sinking must be achieved to ensure intended operation.

Figures 6 and 7 illustrate an example PCB layout. The bottom of the package features an exposed metal pad. The exposed pad acts, thermally, to transfer heat from the chip and, electrically, as a ground connection.

The junction-to-ambient thermal resistance (θ_{JA}) for the connection can be significantly reduced by following a couple of important PCB design guidelines. The PCB area directly underneath the package should be plated so that the exposed paddle can be mated to the top layer PCB copper during the reflow process. Multiple copper plated thru-holes should be used to electrically and thermally connect the top surface pad area to additional ground plane(s).

The chip ground is internally connected to both the exposed pad and to the AGND and PGND pins. It is good practice to connect the GND pins to the exposed pad area with traces.

The flying capacitors (C1 and C2), input capacitors (C3 and C4), and output capacitor (C5, C6, C7, and C8) should be connected as close as possible to the IC. In addition to the external passive components being placed as close as possible to the IC, all traces connecting the AAT2860 should be as short and wide as possible to minimize path resistance and potential coupling.

Manufacturer	Part Number	Value	Voltage	Temp. Co.	Case
AVX	0603ZD105K	$1\mu F$	10	X5R	0603
	0603ZD225K	$2.2\mu F$	10		
TDK	C1608X5R1E105K	$1\mu F$	25	X5R	0603
	C1608X5R1C225K	$2.2\mu F$	16		
	C1608X5R1A475K	$4.7\mu F$	10		
Murata	GRM188R61C105K	$1\mu F$	16	X5R	0603
	GRM188R61A225K	$2.2\mu F$	10		
Taiyo Yuden	LMK107BJ475KA	$4.7\mu F$	10	X5R	0603

Table 11: Surface Mount Capacitors.

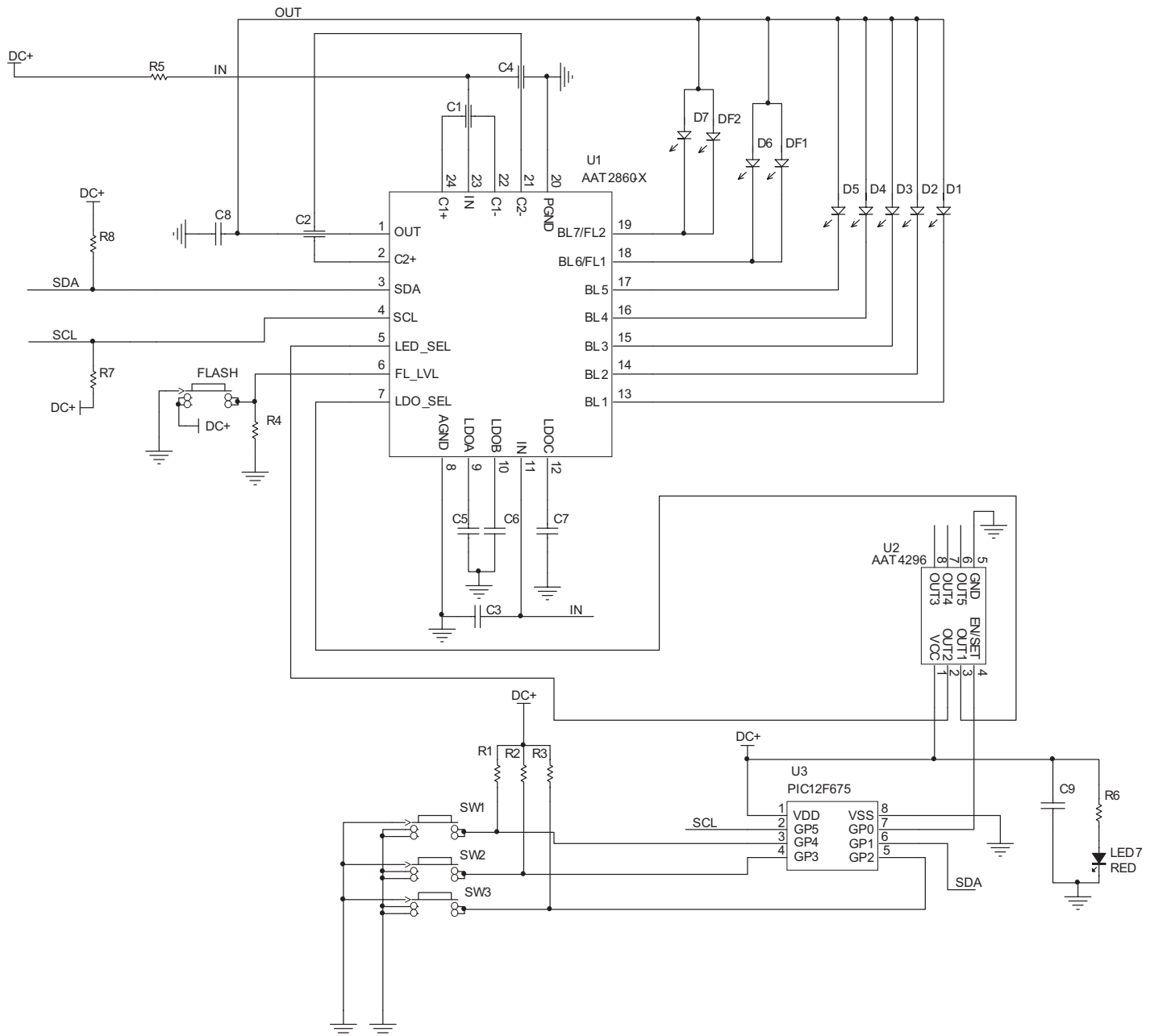

Figure 5: AAT2860 Evaluation Board Schematic.

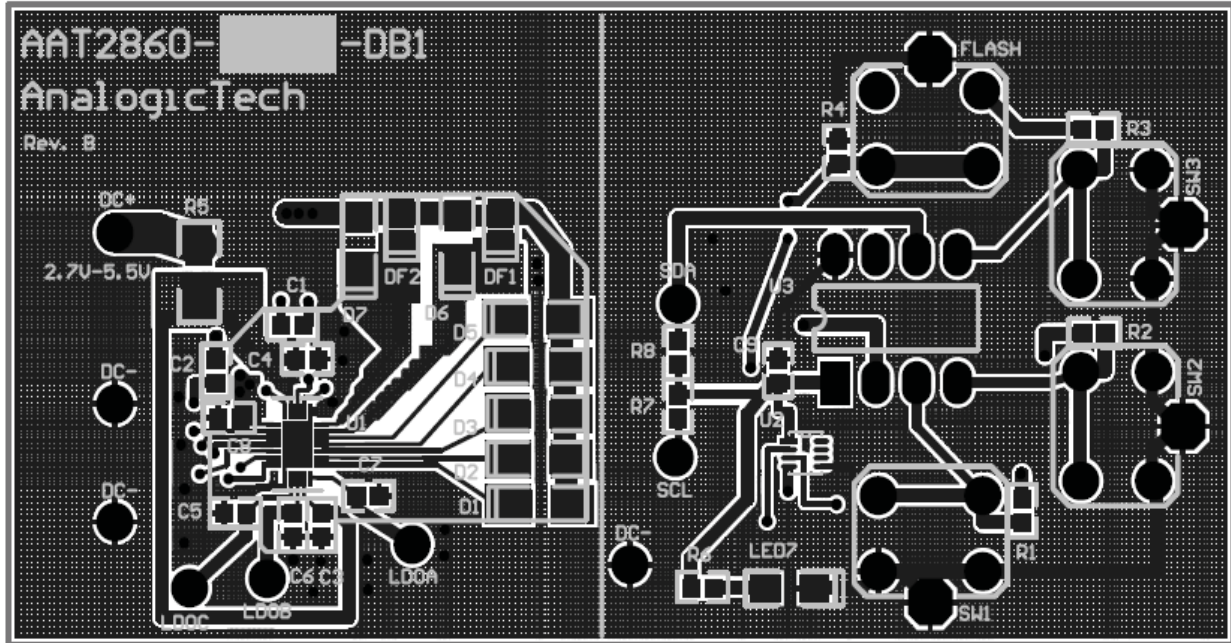

Figure 6: AAT2860 Evaluation Board Top-Side View Layout.

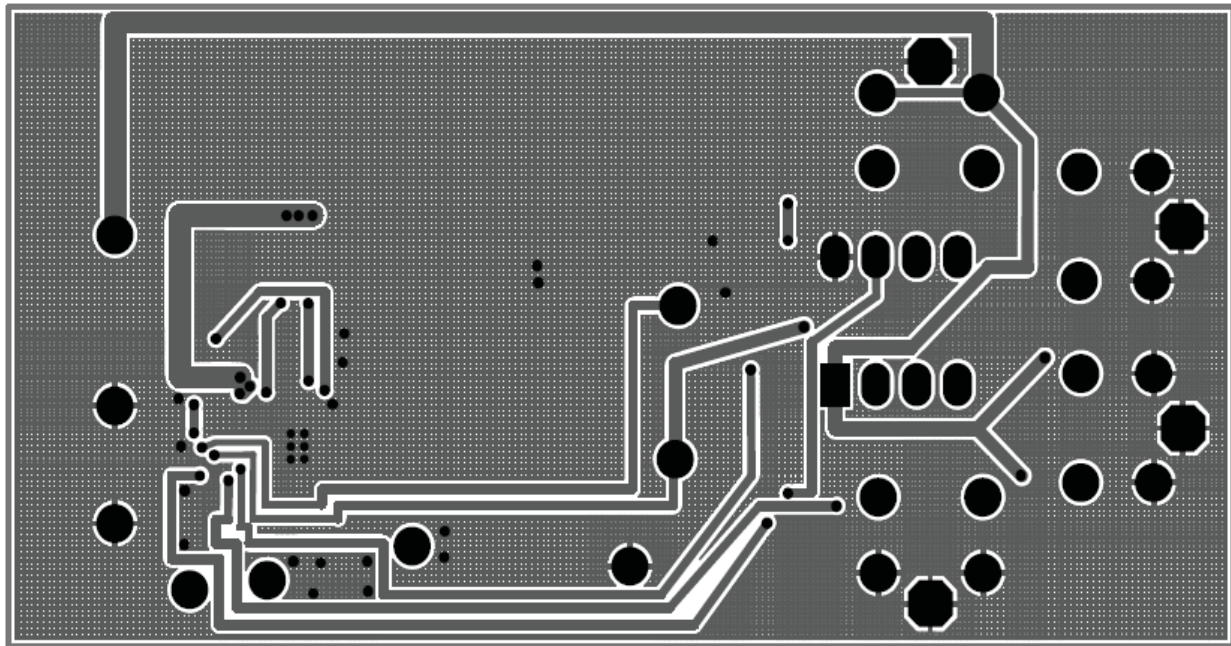

Figure 7: AAT2860 Evaluation Board Bottom-Side View Layout.

Ordering Information

Package	Marking ¹	Part Number (Tape and Reel) ²
TQFN34-24	1GXY	AAT2860IMK-1-T1
TQFN34-24	1WXY	AAT2860IMK-2-T1
TQFN34-24		AAT2860IMK-3-T1
TQFN34-24		AAT2860IMK-4-T1
TQFN34-24		AAT2860IMK-5-T1
TQFN34-24		AAT2860IMK-6-T1



All AnalogicTech products are offered in Pb-free packaging. The term “Pb-free” means semiconductor products that are in compliance with current RoHS standards, including the requirement that lead not exceed 0.1% by weight in homogeneous materials. For more information, please visit our website at <http://www.analogictech.com/about/quality.aspx>.

Package Information

TQFN34-24³

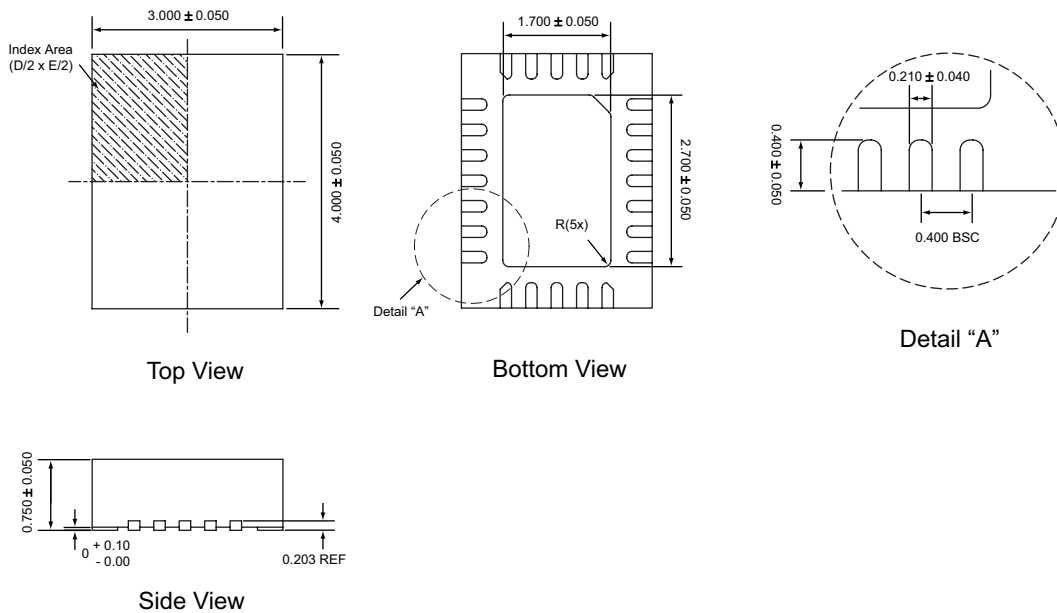

All dimensions in millimeters.

1. XYY = assembly and date code.
 2. Sample stock is generally held on part numbers listed in **BOLD**.
 3. The leadless package family, which includes QFN, TQFN, DFN, TDFN, and STDFN, has exposed copper (unplated) at the end of the lead terminals due to the manufacturing process. A solder fillet at the exposed copper edge cannot be guaranteed and is not required to ensure a proper bottom solder connection.

**ChargePump™ Backlight/Flash LED Driver and Multiple LDO Lighting Management Unit**

Advanced Analogic Technologies, Inc.
3230 Scott Boulevard, Santa Clara, CA 95054
Phone (408) 737-4600
Fax (408) 737-4611



© Advanced Analogic Technologies, Inc.
AnalogicTech cannot assume responsibility for use of any circuitry other than circuitry entirely embodied in an AnalogicTech product. No circuit patent licenses, copyrights, mask work rights, or other intellectual property rights are implied. AnalogicTech reserves the right to make changes to their products or specifications or to discontinue any product or service without notice. Except as provided in AnalogicTech's terms and conditions of sale, AnalogicTech assumes no liability whatsoever, and AnalogicTech disclaims any express or implied warranty relating to the sale and/or use of AnalogicTech products including liability or warranties relating to fitness for a particular purpose, merchantability, or infringement of any patent, copyright or other intellectual property right. In order to minimize risks associated with the customer's applications, adequate design and operating safeguards must be provided by the customer to minimize inherent or procedural hazards. Testing and other quality control techniques are utilized to the extent AnalogicTech deems necessary to support this warranty. Specific testing of all parameters of each device is not necessarily performed. AnalogicTech and the AnalogicTech logo are trademarks of Advanced Analogic Technologies Incorporated. All other brand and product names appearing in this document are registered trademarks or trademarks of their respective holders.