

*Designer's™ Data Sheet*  
**Complementary NPN-PNP  
Silicon Power Bipolar Transistor**

The MJ3281A and MJ1302A are PowerBase power transistors for high power audio, disk head positioners and other linear applications.

- Designed for 100 W Audio Frequency
- Gain Complementary:
  - Gain Linearity from 100 mA to 7 A
  - High Gain — 60 to 175
  - $h_{FE} = 45$  (Min) @  $I_C = 8$  A
- Low Harmonic Distortion
- High Safe Operation Area — 1 A/100 V @ 1 sec
- High  $f_T$  — 30 MHz Typical

**NPN  
MJ3281A\*  
PNP  
MJ1302A\***

\*Motorola Preferred Device

**15 AMPERE  
COMPLEMENTARY  
SILICON POWER  
TRANSISTORS  
200 VOLTS  
250 WATTS**

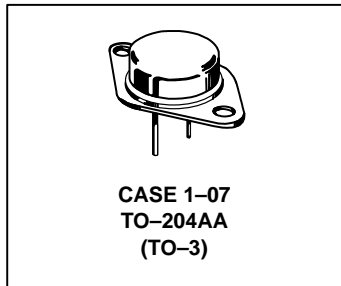

**MAXIMUM RATINGS** ( $T_J = 25^\circ\text{C}$  unless otherwise noted)

Rating	Symbol	Value	Unit
Collector-Emitter Voltage	$V_{CEO}$	200	Vdc
Collector-Base Voltage	$V_{CBO}$	200	Vdc
Emitter-Base Voltage	$V_{EBO}$	7	Vdc
Collector-Emitter Voltage — 1.5 V	$V_{CEX}$	200	Vdc
Collector Current — Continuous — Peak (1)	$I_C$	15 25	Adc
Base Current — Continuous	$I_B$	1.5	Adc
Total Power Dissipation @ $T_C = 25^\circ\text{C}$ Derate Above $25^\circ\text{C}$	$P_D$	250 1.43	Watts W/ $^\circ\text{C}$
Operating and Storage Junction Temperature Range	$T_J, T_{stg}$	-65 to +200	$^\circ\text{C}$

**THERMAL CHARACTERISTICS**

Characteristic	Symbol	Max	Unit
Thermal Resistance, Junction to Case	$R_{\theta JC}$	0.7	$^\circ\text{C}/\text{W}$

(1) Pulse Test: Pulse Width = 5 ms, Duty Cycle <10%.

**Designer's Data for "Worst Case" Conditions** — The Designer's Data Sheet permits the design of most circuits entirely from the information presented. SOA Limit curves — representing boundaries on device characteristics — are given to facilitate "worst case" design.

Designer's is a trademark of Motorola, Inc.

**Preferred** devices are Motorola recommended choices for future use and best overall value.

**MJ3281A MJ1302A****ELECTRICAL CHARACTERISTICS** ( $T_C = 25^\circ\text{C}$  unless otherwise noted)

Characteristic	Symbol	Min	Typ	Max	Unit
<b>OFF CHARACTERISTICS</b>					
Collector–Emitter Sustaining Voltage ( $I_C = 100\text{ mAdc}$ , $I_B = 0$ )	$V_{CEO(sus)}$	200	—	—	Vdc
Emitter–Base Voltage ( $I_E = 100\text{ }\mu\text{Adc}$ , $I_C = 0$ )	$V_{EBO}$	7	—	—	Vdc
Collector Cutoff Current ( $V_{CB} = 200\text{ Vdc}$ , $I_E = 0$ )	$I_{CBO}$	—	—	50	$\mu\text{Adc}$
Emitter Cutoff Current ( $V_{EB} = 5\text{ Vdc}$ , $I_C = 0$ )	$I_{EBO}$	—	—	5	$\mu\text{Adc}$
Emitter Cutoff Current ( $V_{EB} = 7\text{ Vdc}$ , $I_C = 0$ )	$I_{EBO}$	—	—	25	$\mu\text{Adc}$

**SECOND BREAKDOWN**

Second Breakdown Collector with Base Forward Biased ( $V_{CE} = 50\text{ Vdc}$ , $t = 1\text{ s}$ (non-repetitive)) ( $V_{CE} = 100\text{ Vdc}$ , $t = 1\text{ s}$ (non-repetitive))	$I_{S/b}$	4 1	— —	— —	Adc
--	-----------	--------	--------	--------	-----

**ON CHARACTERISTICS**

DC Current Gain ( $I_C = 100\text{ mAdc}$ , $V_{CE} = 5\text{ Vdc}$ ) ( $I_C = 1\text{ Adc}$ , $V_{CE} = 5\text{ Vdc}$ ) ( $I_C = 3\text{ Adc}$ , $V_{CE} = 5\text{ Vdc}$ ) ( $I_C = 5\text{ Adc}$ , $V_{CE} = 5\text{ Vdc}$ ) ( $I_C = 7\text{ Adc}$ , $V_{CE} = 5\text{ Vdc}$ ) ( $I_C = 8\text{ Adc}$ , $V_{CE} = 5\text{ Vdc}$ ) ( $I_C = 15\text{ Adc}$ , $V_{CE} = 5\text{ Vdc}$ )	$h_{FE}$	60 60 60 60 60 45 12	125 — — — 115 — 35	175 175 175 175 175 — —	
Collector–Emitter Saturation Voltage ( $I_C = 10\text{ Adc}$ , $I_B = 1\text{ Adc}$ )	$V_{CE(sat)}$	—	—	3	Vdc

**DYNAMIC CHARACTERISTICS**

Current–Gain — Bandwidth Product ( $I_C = 1\text{ Adc}$ , $V_{CE} = 5\text{ Vdc}$ , $f_{test} = 1\text{ MHz}$ )	$f_T$	—	30	—	MHz
Output Capacitance ( $V_{CB} = 10\text{ Vdc}$ , $I_E = 0$ , $f_{test} = 1\text{ MHz}$ )	$C_{ob}$	—	—	600	pF

(1) Pulse Test: Pulse Width = 300  $\mu\text{s}$ , Duty Cycle  $\leq 2\%$ .

TYPICAL CHARACTERISTICS

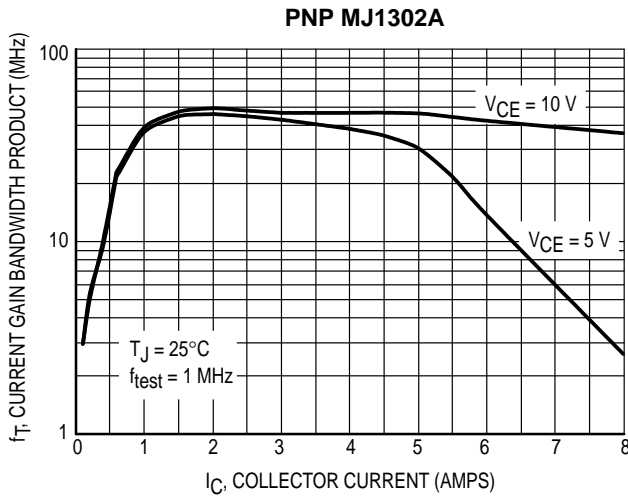

Figure 1. Current-Gain — Bandwidth Product

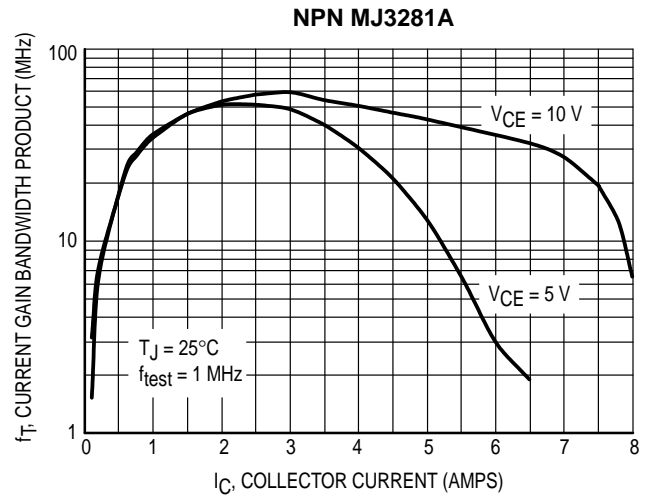

Figure 2. Current-Gain — Bandwidth Product

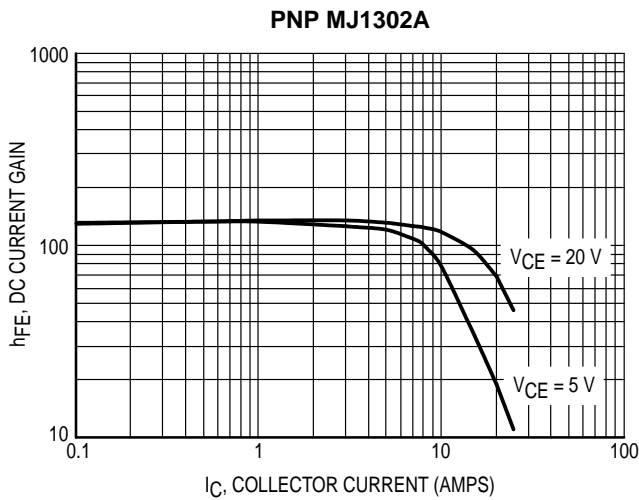

Figure 3. DC Current Gain

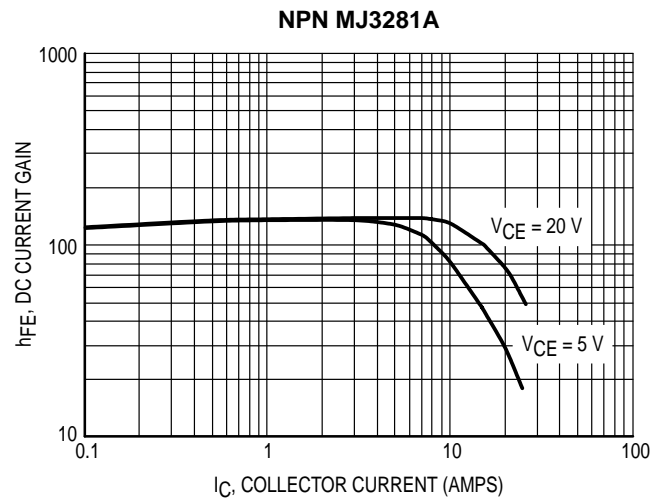

Figure 4. DC Current Gain

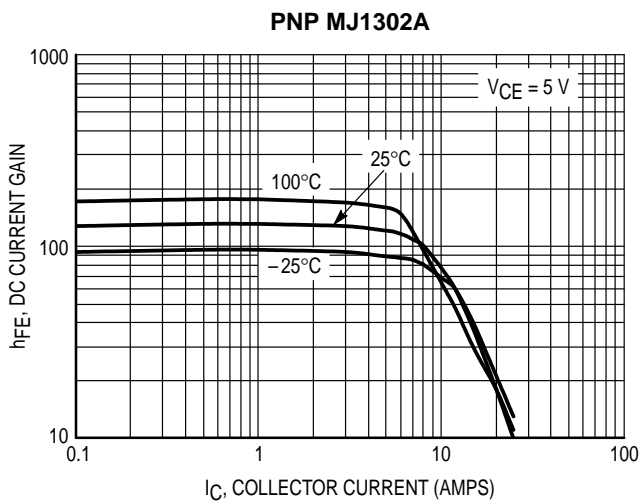

Figure 5. DC Current Gain,  $V_{CE} = 5 V$

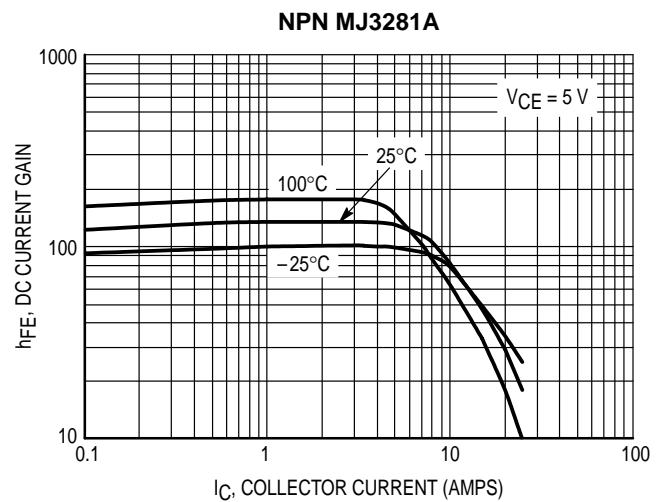

Figure 6. DC Current Gain,  $V_{CE} = 5 V$

TYPICAL CHARACTERISTICS

PNP MJ1302A

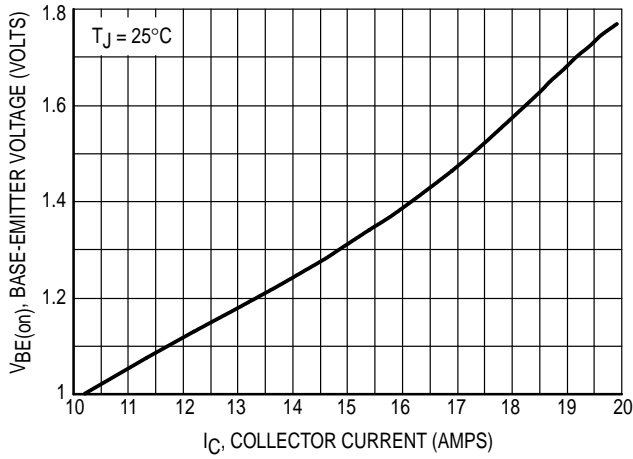

Figure 7. Typical Base–Emitter Voltage

NPN MJ3281A

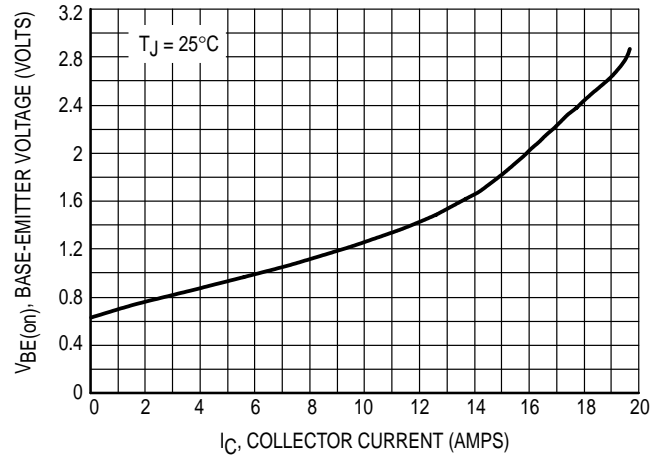

Figure 8. Typical Base–Emitter Voltage

PNP MJ1302A

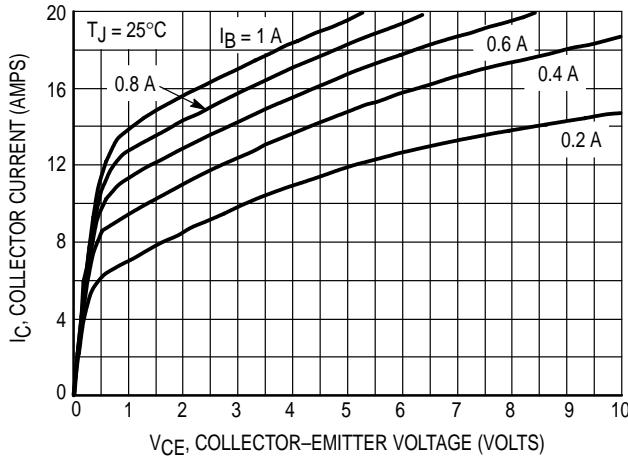

Figure 9. Typical Output Characteristics

NPN MJ3281A

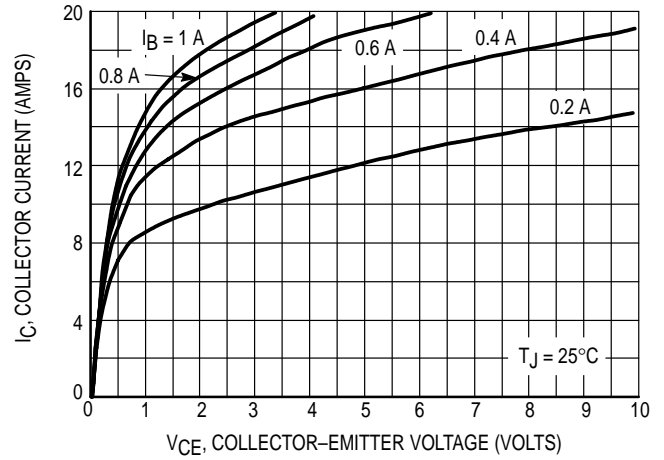

Figure 10. Typical Output Characteristics

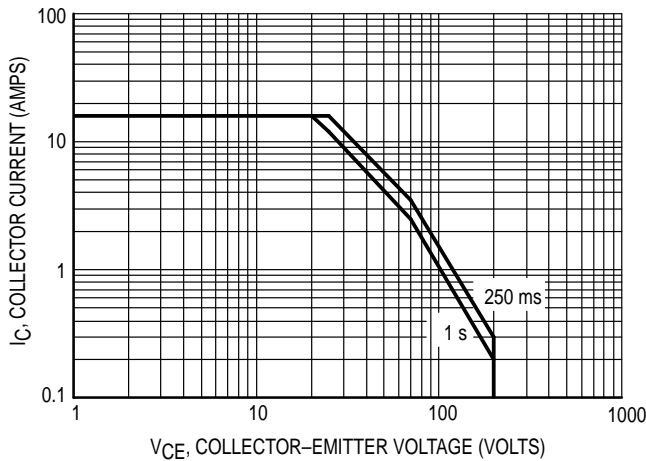
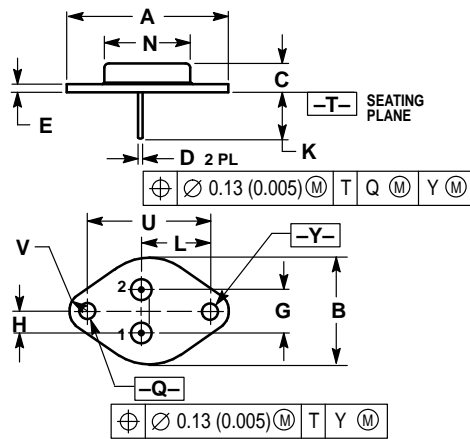

Figure 11. Forward Bias Safe Operating Area (FBSOA)

There are two limitations on the power handling ability of a transistor; average junction temperature and secondary breakdown. Safe operating area curves indicate  $I_C - V_{CE}$  limits of the transistor that must be observed for reliable operation; i.e., the transistor must not be subjected to greater dissipation than the curves indicate.

The data of Figure 11 is based on  $T_{J(pk)} = 200^\circ\text{C}$ ;  $T_C$  is variable depending on conditions. At high case temperatures, thermal limitations will reduce the power than can be handled to values less than the limitations imposed by second breakdown.

PACKAGE DIMENSIONS



- NOTES:
1. DIMENSIONING AND TOLERANCING PER ANSI Y14.5M, 1982.
  2. CONTROLLING DIMENSION: INCH.
  3. ALL RULES AND NOTES ASSOCIATED WITH REFERENCED TO-204AA OUTLINE SHALL APPLY.

DIM	INCHES		MILLIMETERS	
	MIN	MAX	MIN	MAX
A	1.550 REF		39.37 REF	
B	—	1.050	—	26.67
C	0.250	0.335	6.35	8.51
D	0.038	0.043	0.97	1.09
E	0.055	0.070	1.40	1.77
G	0.430 BSC		10.92 BSC	
H	0.215 BSC		5.46 BSC	
K	0.440	0.480	11.18	12.19
L	0.665 BSC		16.89 BSC	
N	—	0.830	—	21.08
Q	0.151	0.165	3.84	4.19
U	1.187 BSC		30.15 BSC	
V	0.131	0.188	3.33	4.77

STYLE 1:  
 PIN 1. BASE  
 2. EMITTER  
 CASE: COLLECTOR

CASE 1-07  
 TO-204AA (TO-3)  
 ISSUE Z

Motorola reserves the right to make changes without further notice to any products herein. Motorola makes no warranty, representation or guarantee regarding the suitability of its products for any particular purpose, nor does Motorola assume any liability arising out of the application or use of any product or circuit, and specifically disclaims any and all liability, including without limitation consequential or incidental damages. "Typical" parameters can and do vary in different applications. All operating parameters, including "Typicals" must be validated for each customer application by customer's technical experts. Motorola does not convey any license under its patent rights nor the rights of others. Motorola products are not designed, intended, or authorized for use as components in systems intended for surgical implant into the body, or other applications intended to support or sustain life, or for any other application in which the failure of the Motorola product could create a situation where personal injury or death may occur. Should Buyer purchase or use Motorola products for any such unintended or unauthorized application, Buyer shall indemnify and hold Motorola and its officers, employees, subsidiaries, affiliates, and distributors harmless against all claims, costs, damages, and expenses, and reasonable attorney fees arising out of, directly or indirectly, any claim of personal injury or death associated with such unintended or unauthorized use, even if such claim alleges that Motorola was negligent regarding the design or manufacture of the part. Motorola and  are registered trademarks of Motorola, Inc. Motorola, Inc. is an Equal Opportunity/Affirmative Action Employer.

**How to reach us:**

**USA / EUROPE:** Motorola Literature Distribution;  
P.O. Box 20912; Phoenix, Arizona 85036. 1-800-441-2447

**JAPAN:** Nippon Motorola Ltd.; Tatsumi-SPD-JLDC, Toshikatsu Otsuki,  
6F Seibu-Butsuryu-Center, 3-14-2 Tatsumi Koto-Ku, Tokyo 135, Japan. 03-3521-8315

**MFAX:** RMFAX0@email.sps.mot.com – TOUCHTONE (602) 244-6609  
**INTERNET:** <http://Design-NET.com>

**HONG KONG:** Motorola Semiconductors H.K. Ltd.; 8B Tai Ping Industrial Park,  
51 Ting Kok Road, Tai Po, N.T., Hong Kong. 852-26629298

