

STANDARD TRIACS

FEATURES

- HIGH SURGE CURRENT CAPABILITY
- COMMUTATION : $(dV/dt)_c > 10V/\mu s$
- BTA Family :
INSULATING VOLTAGE = $2500V_{(RMS)}$
(UL RECOGNIZED : E81734)

DESCRIPTION

The BTA41 A/B / BTB41 B triac family are high performance glass passivated PNP devices. These parts are suitable for general purpose applications where high surge current capability is required. Application such as phase control and static switching on inductive or resistive load.

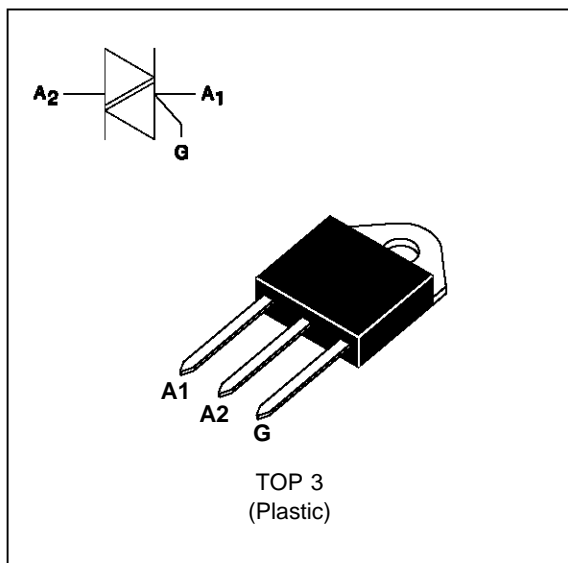

ABSOLUTE RATINGS (limiting values)

Symbol	Parameter		Value	Unit	
I _{T(RMS)}	RMS on-state current (360° conduction angle)	BTA	T _c = 75 °C	40	A
		BTB	T _c = 85 °C	45	
I _{TSM}	Non repetitive surge peak on-state current (T _j initial = 25°C)		tp = 8.3 ms	315	A
			tp = 10 ms	300	
i ² t	i ² t value		tp = 10 ms	450	A ² s
di/dt	Critical rate of rise of on-state current Gate supply : I _G = 500mA di _G /dt = 1A/μs		Repetitive F = 50 Hz	10	A/μs
			Non Repetitive	50	
T _{stg} T _j	Storage and operating junction temperature range		- 40 to + 150 - 40 to + 125	°C °C	
T _l	Maximum lead temperature for soldering during 10 s at 4.5 mm from case		260	°C	

Symbol	Parameter	BTA41-...A/B / BTB41-... B				Unit
		400	600	700	800	
V _{DRM} V _{RRM}	Repetitive peak off-state voltage T _j = 125 °C	400	600	700	800	V

THERMAL RESISTANCES

Symbol	Parameter		Value	Unit
Rth (j-a)	Junction to ambient		50	°C/W
Rth (j-c) DC	Junction to case for DC	BTA	1.2	°C/W
		BTB	0.8	
Rth (j-c) AC	Junction to case for 360° conduction angle (F= 50 Hz)	BTA	0.9	°C/W
		BTB	0.6	

GATE CHARACTERISTICS (maximum values)

PG (AV) = 1W PGM = 40W (tp = 20 μs) IGM = 8A (tp = 20 μs) VGM = 16V (tp = 20 μs).

ELECTRICAL CHARACTERISTICS

Symbol	Test Conditions	Quadrant		Suffix		Unit
				A	B	
IGT	VD=12V (DC) RL=33Ω Tj=25°C	I-II-III	MAX	100	50	mA
		IV	MAX	150	100	
VGT	VD=12V (DC) RL=33Ω Tj=25°C	I-II-III-IV	MAX	1.5		V
VGD	VD=VDRM RL=3.3kΩ Tj=125°C	I-II-III-IV	MIN	0.2		V
tgt	VD=VDRM IG = 500mA dIG/dt = 3A/μs Tj=25°C	I-II-III-IV	TYP	2.5		μs
IL	IG=1.2 IGT Tj=25°C	I-III-IV	TYP	70	60	mA
		II		200	180	
IH *	IT= 500mA gate open Tj=25°C		MAX	100	80	mA
VTM *	ITM= 60A tp= 380μs Tj=25°C		MAX	1.8		V
IDRM IRRM	VDRM Rated VRRM Rated Tj=25°C		MAX	0.01		mA
			MAX	6		
dV/dt *	Linear slope up to VD=67%VDRM gate open Tj=125°C		MIN	250	250	V/μs
(dV/dt)c *	(dI/dt)c = 18A/ms BTA (dI/dt)c = 20A/ms BTB Tj=125°C		MIN	10		V/μs

* For either polarity of electrode A2 voltage with reference to electrode A1.

ORDERING INFORMATION

Package	$I_T(\text{RMS})$	$V_{\text{DRM}} / V_{\text{RRM}}$	Sensitivity Specification	
	A	V	A	B
BTA (Insulated)	41	400	X	X
		600	X	X
		700	X	X
		800	X	X
BTB (Uninsulated)	45	400		X
		600		X
		700		X
		800		X

Fig.1 : Maximum RMS power dissipation versus RMS on-state current (F=50Hz).
(Curves are cut off by (di/dt)c limitation) (BTA)

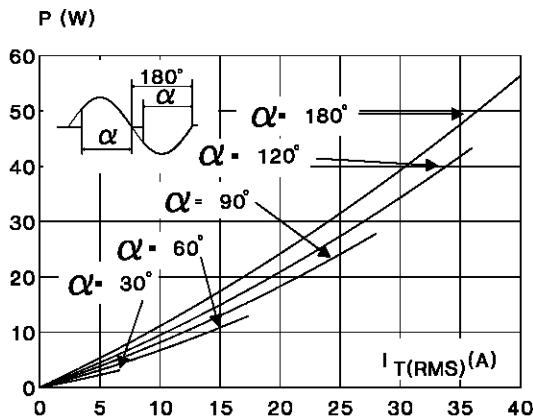

Fig.3 : Maximum RMS power dissipation versus RMS on-state current (F=50Hz).
(Curves are cut off by (di/dt)c limitation) (BTB)

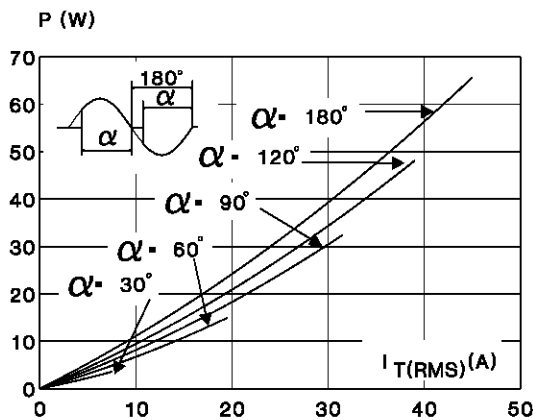

Fig.2 : Correlation between maximum RMS power dissipation and maximum allowable temperatures (T_{amb} and T_{case}) for different thermal resistances heatsink + contact (BTA).

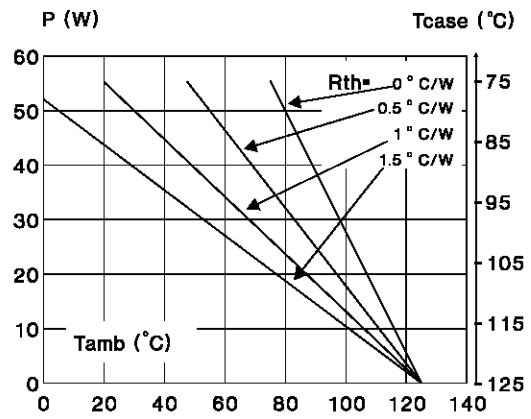
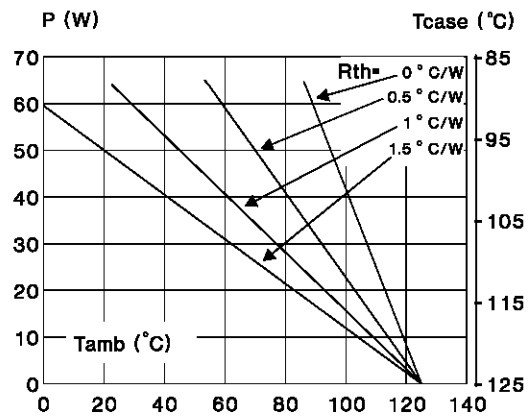

Fig.4 : Correlation between maximum RMS power dissipation and maximum allowable temperatures (T_{amb} and T_{case}) for different thermal resistances heatsink + contact (BTB).



BTA41 A/B / BTB41 B

Fig.5 : RMS on-state current versus case temperature. (BTA)

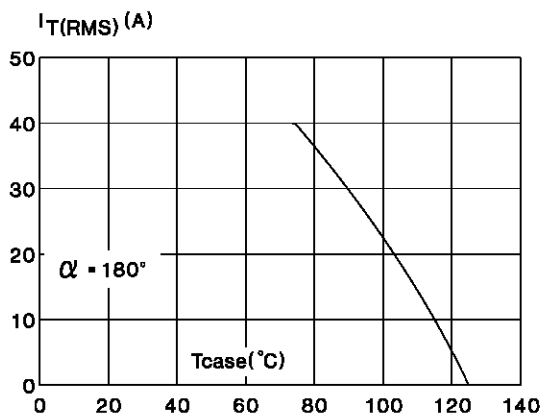

Fig.6 : RMS on-state current versus case temperature. (BTB)

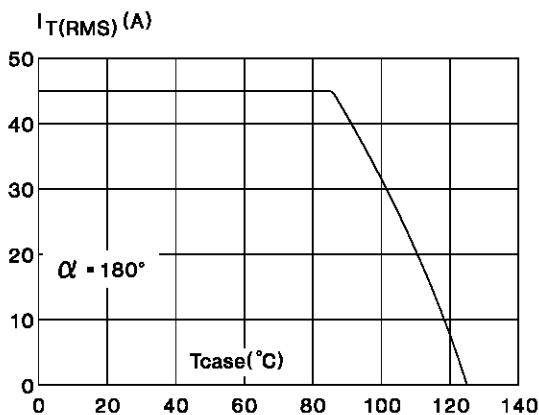

Fig.7 : Relative variation of thermal transient impedance pulse duration.

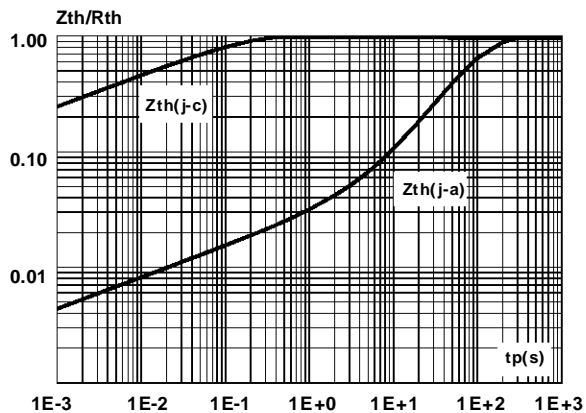

Fig.8 : Relative variation of gate trigger current and holding current versus junction temperature.

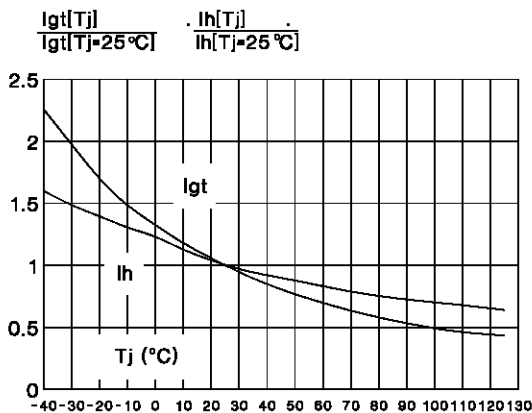

Fig.9 : Non Repetitive surge peak on-state current versus number of cycles.

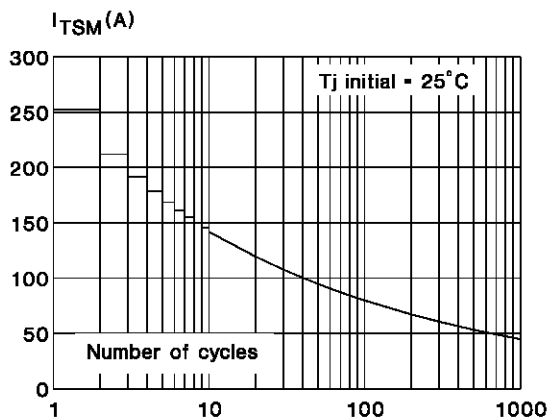

Fig.10 : Non repetitive surge peak on-state current for a sinusoidal pulse with width : $t \leq 10\text{ms}$, and corresponding value of I^2t .

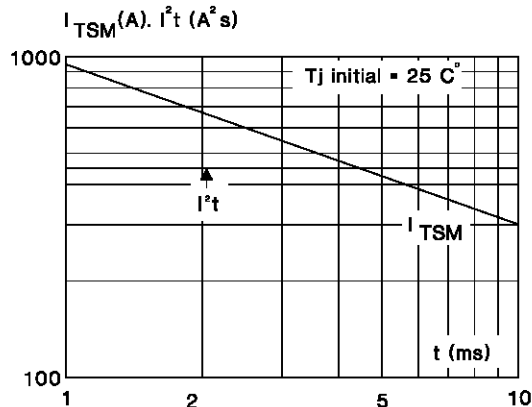
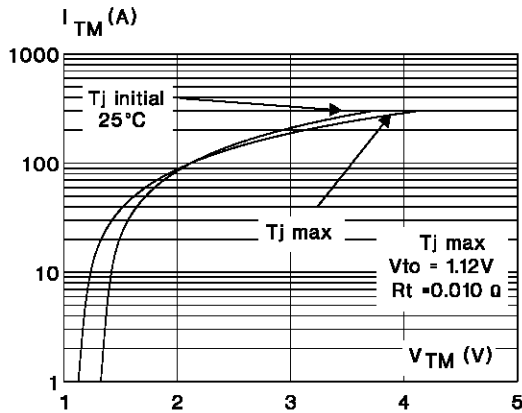
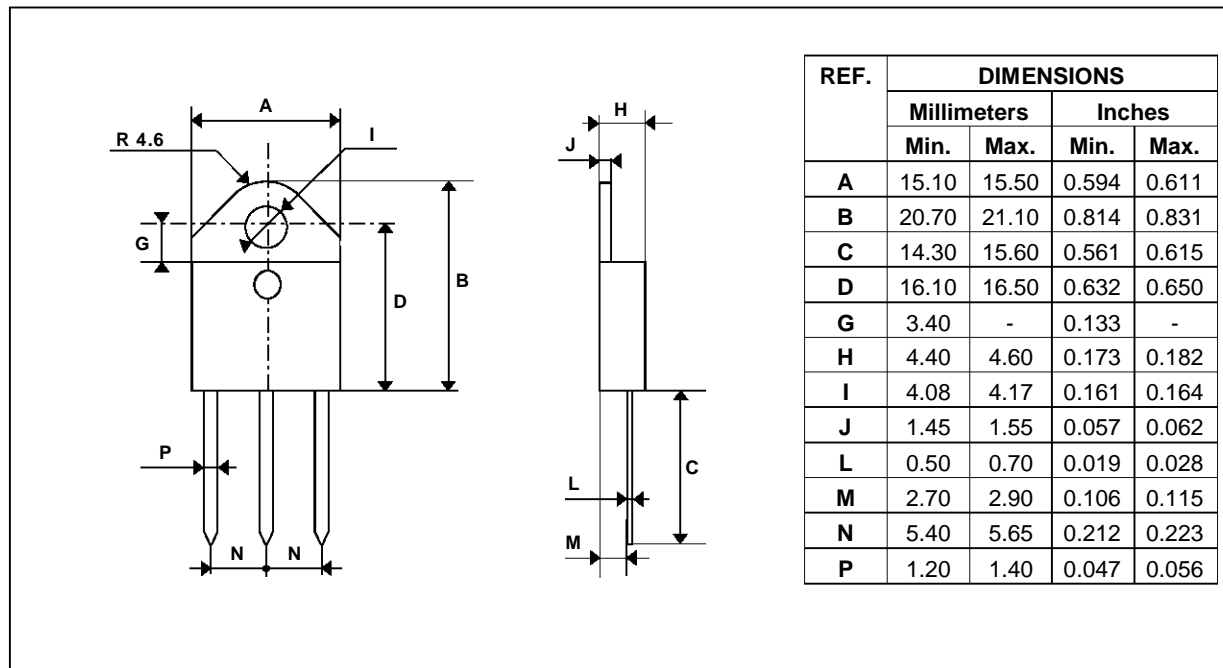

Fig.11 : On-state characteristics (maximum values).



PACKAGE MECHANICAL DATA

TOP 3 Plastic



Cooling method : C
 Marking : type number
 Weight : 4.7 g

Recommended torque value : 0.8 m.N.
 Maximum torqu value : 1 m.N.

Information furnished is believed to be accurate and reliable. However, SGS-THOMSON Microelectronics assumes no responsibility for the consequences of use of such information nor for any infringement of patents or other rights of third parties which may result from its use. No license is granted by implication or otherwise under any patent or patent rights of SGS-THOMSON Microelectronics. Specifications mentioned in this publication are subject to change without notice. This publication supersedes and replaces all information previously supplied.

SGS-THOMSON Microelectronics products are not authorized for use as critical components in life support devices or systems without express written approval of SGS-THOMSON Microelectronics.

© 1995 SGS-THOMSON Microelectronics - Printed in Italy - All rights reserved.

SGS-THOMSON Microelectronics GROUP OF COMPANIES

Australia - Brazil - France - Germany - Hong Kong - Italy - Japan - Korea - Malaysia - Malta - Morocco - The Netherlands - Singapore - Spain - Sweden - Switzerland - Taiwan - Thailand - United Kingdom - U.S.A.