



MICROCHIP

# MCP3201

## 2.7V 12-Bit A/D Converter with SPI<sup>®</sup> Serial Interface

### FEATURES

- 12-bit resolution
- $\pm 1$  LSB max DNL
- $\pm 1$  LSB max INL (MCP3201-B)
- $\pm 2$  LSB max INL (MCP3201-C)
- On-chip sample and hold
- SPI<sup>®</sup> serial interface (modes 0,0 and 1,1)
- Single supply operation: 2.7V - 5.5V
- 100ksps max. sampling rate at  $V_{DD} = 5V$
- 50ksps max. sampling rate at  $V_{DD} = 2.7V$
- Low power CMOS technology
  - 500nA typical standby current, 2 $\mu$ A max.
  - 400 $\mu$ A max. active current at 5V
- Industrial temp range: -40°C to +85°C
- 8-pin PDIP, SOIC and TSSOP packages

### APPLICATIONS

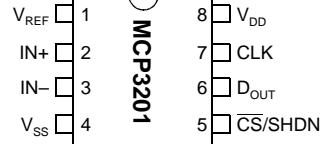
- Sensor Interface
- Process Control
- Data Acquisition
- Battery Operated Systems

### DESCRIPTION

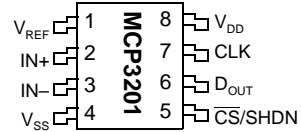
The Microchip Technology Inc. MCP3201 is a successive approximation 12-bit Analog-to-Digital (A/D) Converter with on-board sample and hold circuitry. The device provides a single pseudo-differential input. Differential Nonlinearity (DNL) is specified at  $\pm 1$  LSB, and Integral Nonlinearity (INL) is offered in  $\pm 1$  LSB (MCP3201-B) and  $\pm 2$  LSB (MCP3201-C) versions. Communication with the device is done using a simple serial interface compatible with the SPI protocol. The device is capable of sample rates of up to 100ksps at a clock rate of 1.6MHz. The MCP3201 operates over a broad voltage range (2.7V - 5.5V). Low current design permits operation with typical standby and active currents of only 500nA and 300 $\mu$ A, respectively. The device is offered in 8-pin PDIP, TSSOP and 150mil SOIC packages.

### PACKAGE TYPES

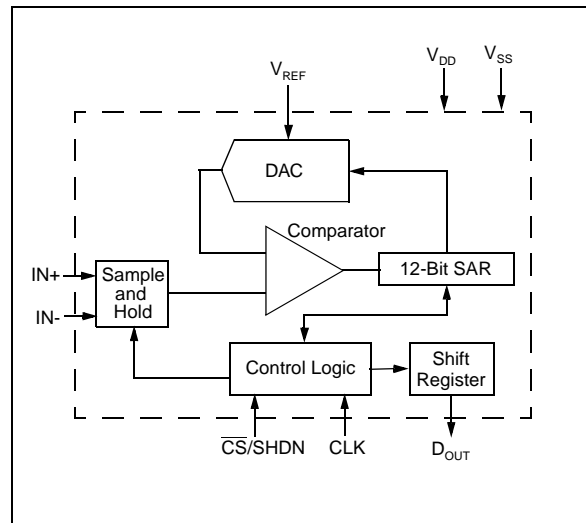
#### PDIP



#### SOIC, TSSOP



### FUNCTIONAL BLOCK DIAGRAM



# MCP3201

## 1.0 ELECTRICAL CHARACTERISTICS

### 1.1 Maximum Ratings\*

$V_{DD}$  ..... 7.0V  
 All inputs and outputs w.r.t.  $V_{SS}$  ..... -0.6V to  $V_{DD} + 0.6V$   
 Storage temperature ..... -65°C to +150°C  
 Ambient temp. with power applied ..... -65°C to +125°C  
 Soldering temperature of leads (10 seconds) .. +300°C  
 ESD protection on all pins ..... > 4kV

\*Notice: Stresses above those listed under "Maximum ratings" may cause permanent damage to the device. This is a stress rating only and functional operation of the device at those or any other conditions above those indicated in the operational listings of this specification is not implied. Exposure to maximum rating conditions for extended periods may affect device reliability.

## PIN FUNCTION TABLE

NAME	FUNCTION
$V_{DD}$	+2.7V to 5.5V Power Supply
$V_{SS}$	Ground
IN+	Positive Analog Input
IN-	Negative Analog Input
CLK	Serial Clock
$D_{OUT}$	Serial Data Out
$\overline{CS}/SHDN$	Chip select/Shutdown Input
$V_{REF}$	Reference Voltage Input

## ELECTRICAL CHARACTERISTICS

All parameters apply at  $V_{DD} = 5V$ ,  $V_{SS} = 0V$ ,  $V_{REF} = 5V$ ,  $T_{AMB} = -40^{\circ}C$  to  $+85^{\circ}C$ ,  $f_{SAMPLE} = 100ksps$  and  $f_{CLK} = 16 * f_{SAMPLE}$  unless otherwise noted.

PARAMETER	SYMBOL	MIN.	TYP.	MAX.	UNITS	CONDITIONS
<b>Conversion Rate</b>						
Conversion Time	$t_{CONV}$			12	clock cycles	
Analog Input Sample Time	$t_{SAMPLE}$		1.5		clock cycles	
Throughput Rate	$f_{SAMPLE}$			100 50	ksps ksps	$V_{DD} = V_{REF} = 5V$ $V_{DD} = V_{REF} = 2.7V$
<b>DC Accuracy</b>						
Resolution			12		bits	
Integral Nonlinearity	INL		$\pm 0.75$ $\pm 1$	$\pm 1$ $\pm 2$	LSB LSB	MCP3201-B MCP3201-C
Differential Nonlinearity	DNL		$\pm 0.5$	$\pm 1$	LSB	No missing codes over temperature
Offset Error			$\pm 1.25$	$\pm 3$	LSB	
Gain Error			$\pm 1.25$	$\pm 5$	LSB	
<b>Dynamic Performance</b>						
Total Harmonic Distortion			-82		dB	$V_{IN} = 0.1V$ to $4.9V @ 1kHz$
Signal to Noise and Distortion (SINAD)			72		dB	$V_{IN} = 0.1V$ to $4.9V @ 1kHz$
Spurious Free Dynamic Range			86		dB	$V_{IN} = 0.1V$ to $4.9V @ 1kHz$
<b>Reference Input</b>						
Voltage Range		0.25		$V_{DD}$	V	Note 2
Current Drain			100 .001	150 3	$\mu A$ $\mu A$	$\overline{CS} = V_{DD} = 5V$
<b>Analog Inputs</b>						
Input Voltage Range (IN+)		IN-		$V_{REF} + IN-$	V	
Input Voltage Range (IN-)		$V_{SS} - 100$		$V_{SS} + 100$	mV	
Leakage Current			0.001	$\pm 1$	$\mu A$	
Switch Resistance	$R_{SS}$		1K		$\Omega$	See Figure 4-1
Sample Capacitor	$C_{SAMPLE}$		20		pF	See Figure 4-1

## ELECTRICAL CHARACTERISTICS (CONTINUED)

All parameters apply at $V_{DD} = 5V$ , $V_{SS} = 0V$ , $V_{REF} = 5V$ , $T_{AMB} = -40^{\circ}C$ to $+85^{\circ}C$ , $f_{SAMPLE} = 100ksps$ and $f_{CLK} = 16 * f_{SAMPLE}$ unless otherwise noted.						
PARAMETER	SYMBOL	MIN.	TYP.	MAX.	UNITS	CONDITIONS
<b>Digital Input/Output</b>						
Data Coding Format		Straight Binary				
High Level Input Voltage	$V_{IH}$	$0.7 V_{DD}$			V	
Low Level Input Voltage	$V_{IL}$			$0.3 V_{DD}$	V	
High Level Output Voltage	$V_{OH}$	4.1			V	$I_{OH} = -1mA$ , $V_{DD} = 4.5V$
Low Level Output Voltage	$V_{OL}$			0.4	V	$I_{OL} = 1mA$ , $V_{DD} = 4.5V$
Input Leakage Current	$I_{LI}$	-10		10	$\mu A$	$V_{IN} = V_{SS}$ or $V_{DD}$
Output Leakage Current	$I_{LO}$	-10		10	$\mu A$	$V_{OUT} = V_{SS}$ or $V_{DD}$
Pin Capacitance (all inputs/outputs)	$C_{IN}$ , $C_{OUT}$			10	pF	$V_{DD} = 5.0V$ (Note 1) $T_{AMB} = 25^{\circ}C$ , $f = 1$ MHz
<b>Timing Parameters</b>						
Clock Frequency	$f_{CLK}$			1.6 0.8	MHz MHz	$V_{DD} = 5V$ (Note 3) $V_{DD} = 2.7V$ (Note 3)
Clock High Time	$t_{HI}$	312			ns	
Clock Low Time	$t_{LO}$	312			ns	
CS Fall To First Rising CLK Edge	$t_{SUCS}$	100			ns	
CLK Fall To Output Data Valid	$t_{DO}$			200	ns	See Test Circuits, Figure 1-2
CLK Fall To Output Enable	$t_{EN}$			200	ns	See Test Circuits, Figure 1-2
CS Rise To Output Disable	$t_{DIS}$			100	ns	See Test Circuits, Figure 1-2 (Note 1)
CS Disable Time	$t_{CSH}$	625			ns	
$D_{OUT}$ Rise Time	$t_R$			100	ns	See Test Circuits, Figure 1-2 (Note 1)
$D_{OUT}$ Fall Time	$t_F$			100	ns	See Test Circuits, Figure 1-2 (Note 1)
<b>Power Requirements</b>						
Operating Voltage	$V_{DD}$	2.7		5.5	V	
Operating Current	$I_{DD}$		300 210	400	$\mu A$ $\mu A$	$V_{DD} = 5.0V$ , $D_{OUT}$ unloaded $V_{DD} = 2.7V$ , $D_{OUT}$ unloaded
Standby Current	$I_{DDS}$		0.5	2	$\mu A$	$CS = V_{DD} = 5.0V$

**Note 1:** This parameter is guaranteed by characterization and not 100% tested.

**2:** See graph that relates linearity performance to  $V_{REF}$  level.

**3:** Because the sample cap will eventually lose charge, effective clock rates below 10kHz can affect linearity performance, especially at elevated temperatures. See Section 6.2 for more information.

# MCP3201

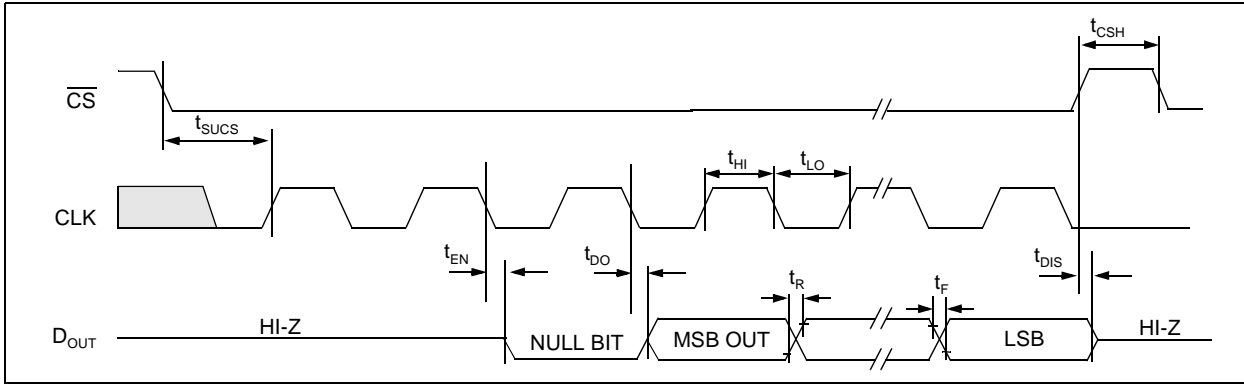


FIGURE 1-1: Serial Timing.

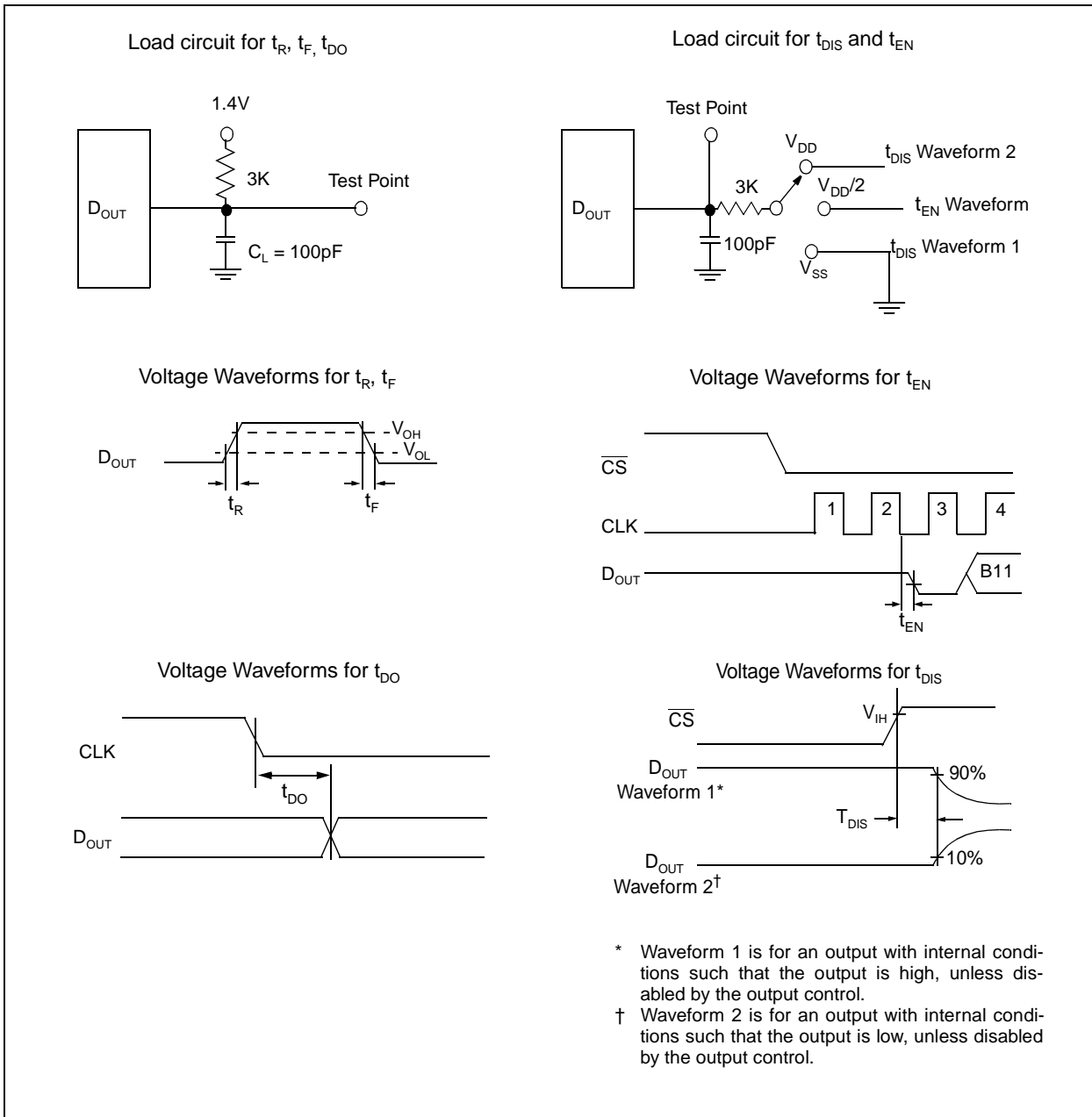
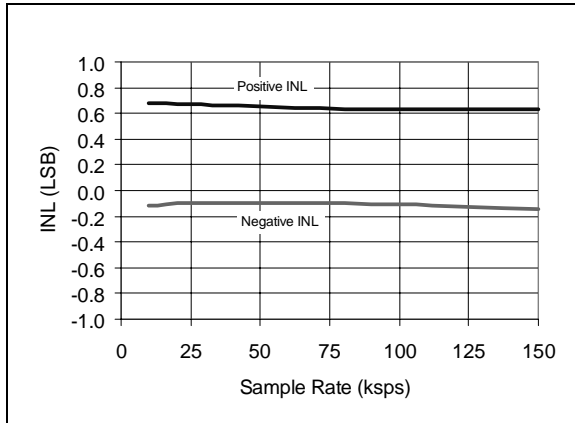


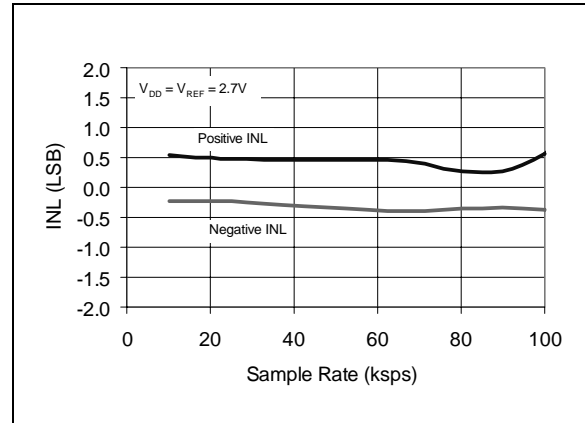
FIGURE 1-2: Test Circuits.

## 2.0 TYPICAL PERFORMANCE CHARACTERISTICS

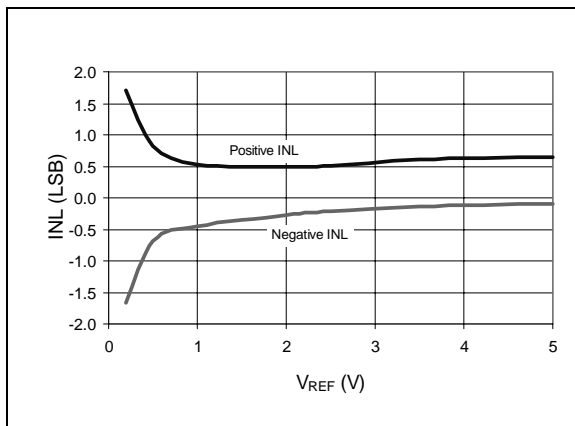
**Note:** Unless otherwise indicated,  $V_{DD} = V_{REF} = 5V$ ,  $V_{SS} = 0V$ ,  $f_{SAMPLE} = 100\text{kpsps}$ ,  $f_{CLK} = 16 * f_{SAMPLE}$ ,  $T_A = 25^\circ\text{C}$



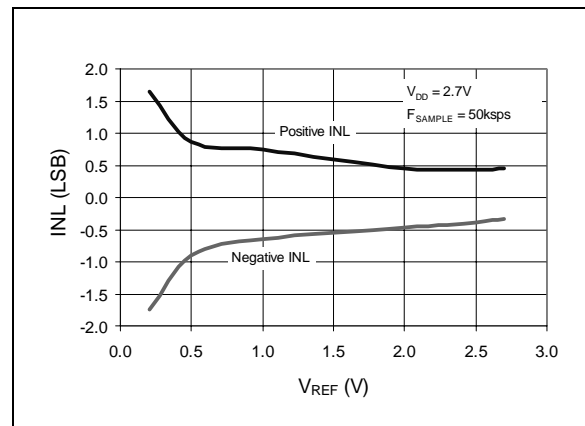
**FIGURE 2-1:** Integral Nonlinearity (INL) vs. Sample Rate.



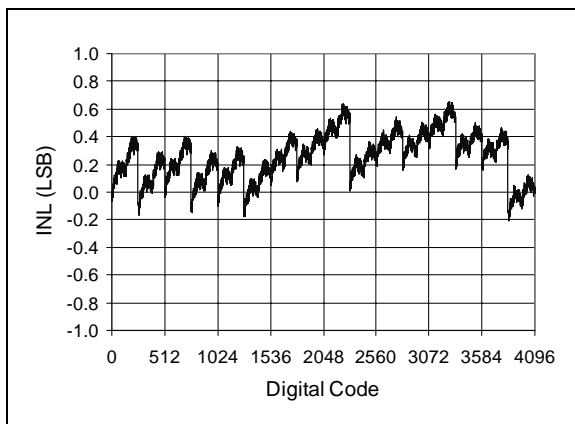
**FIGURE 2-4:** Integral Nonlinearity (INL) vs. Sample Rate ( $V_{DD} = 2.7V$ ).



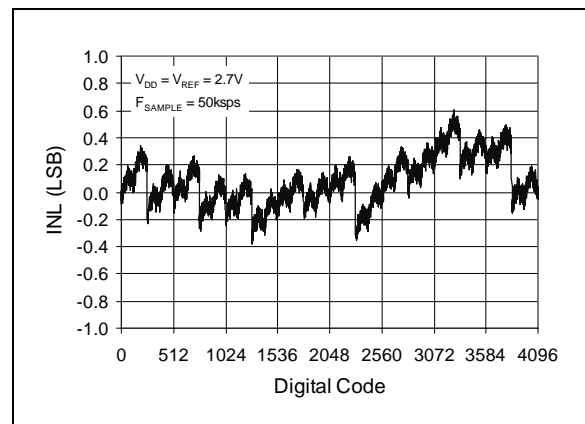
**FIGURE 2-2:** Integral Nonlinearity (INL) vs.  $V_{REF}$ .



**FIGURE 2-5:** Integral Nonlinearity (INL) vs.  $V_{REF}$  ( $V_{DD} = 2.7V$ ).

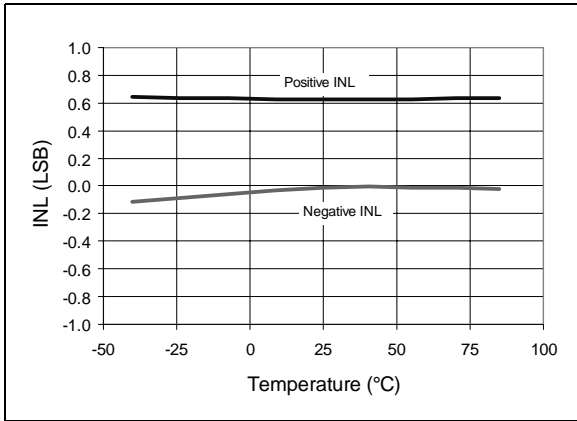


**FIGURE 2-3:** Integral Nonlinearity (INL) vs. Code (Representative Part).

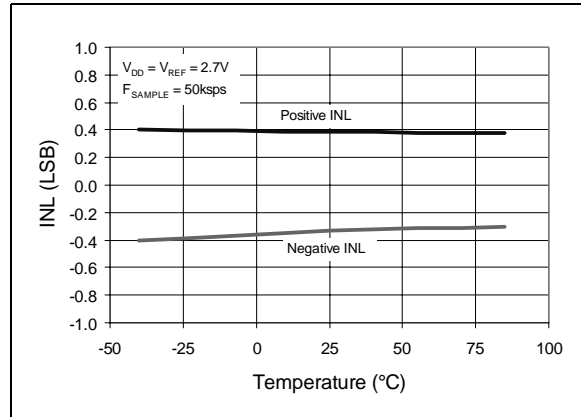


**FIGURE 2-6:** Integral Nonlinearity (INL) vs. Code (Representative Part,  $V_{DD} = 2.7V$ ).

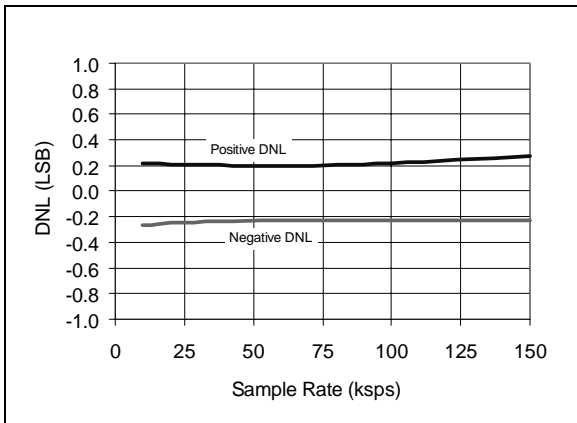
**Note:** Unless otherwise indicated,  $V_{DD} = V_{REF} = 5V$ ,  $V_{SS} = 0V$ ,  $f_{SAMPLE} = 100\text{kpsps}$ ,  $f_{CLK} = 16 \cdot f_{SAMPLE}$ ,  $T_A = 25^\circ\text{C}$



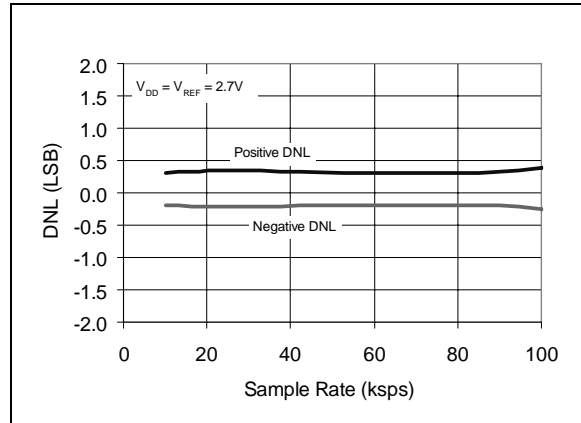
**FIGURE 2-7:** Integral Nonlinearity (INL) vs. Temperature.



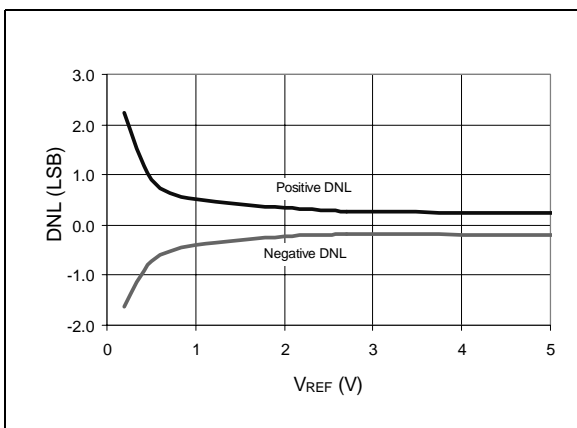
**FIGURE 2-10:** Integral Nonlinearity (INL) vs. Temperature ( $V_{DD} = 2.7V$ ).



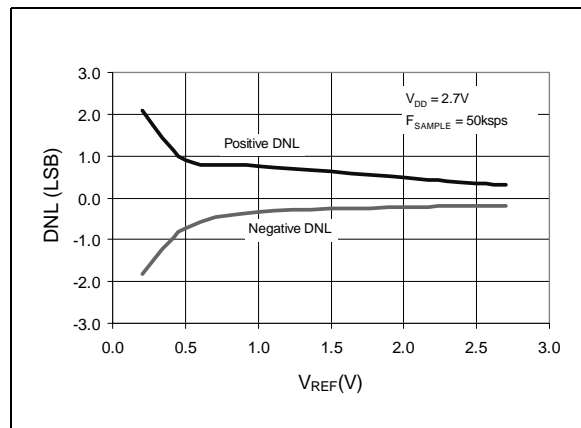
**FIGURE 2-8:** Differential Nonlinearity (DNL) vs. Sample Rate.



**FIGURE 2-11:** Differential Nonlinearity (DNL) vs. Sample Rate ( $V_{DD} = 2.7V$ ).

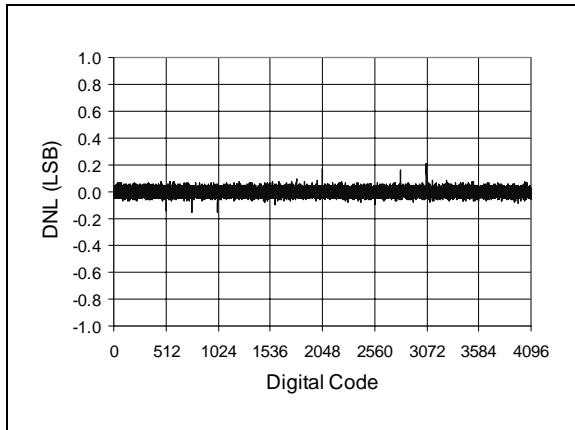


**FIGURE 2-9:** Differential Nonlinearity (DNL) vs.  $V_{REF}$ .

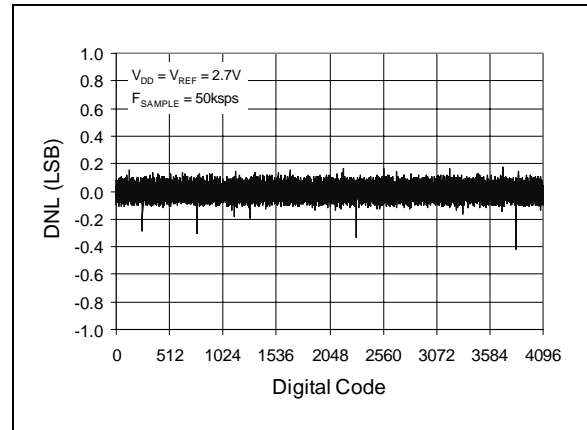


**FIGURE 2-12:** Differential Nonlinearity (DNL) vs.  $V_{REF}$  ( $V_{DD} = 2.7V$ ).

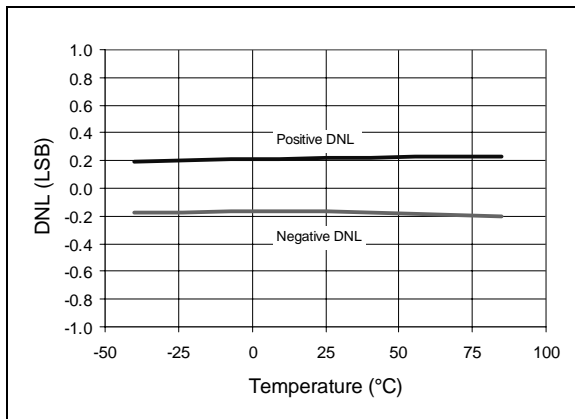
**Note:** Unless otherwise indicated,  $V_{DD} = V_{REF} = 5V$ ,  $V_{SS} = 0V$ ,  $f_{SAMPLE} = 100\text{kpsps}$ ,  $f_{CLK} = 16 \cdot f_{SAMPLE}$ ,  $T_A = 25^\circ\text{C}$



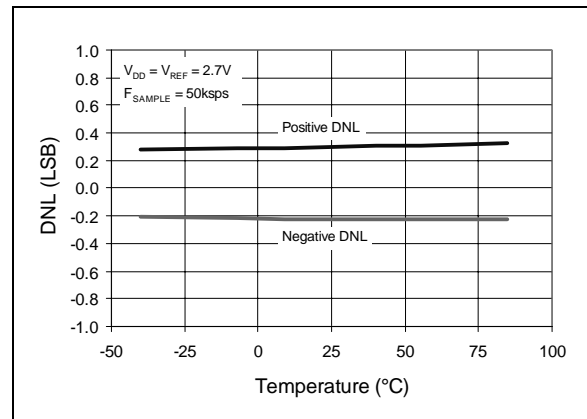
**FIGURE 2-13:** Differential Nonlinearity (DNL) vs. Code (Representative Part).



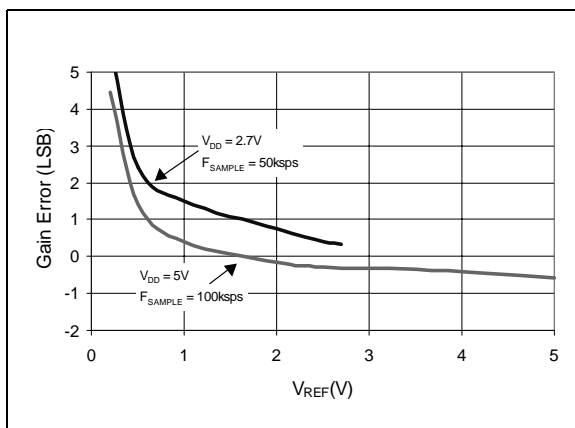
**FIGURE 2-16:** Differential Nonlinearity (DNL) vs. Code (Representative Part,  $V_{DD} = 2.7V$ ).



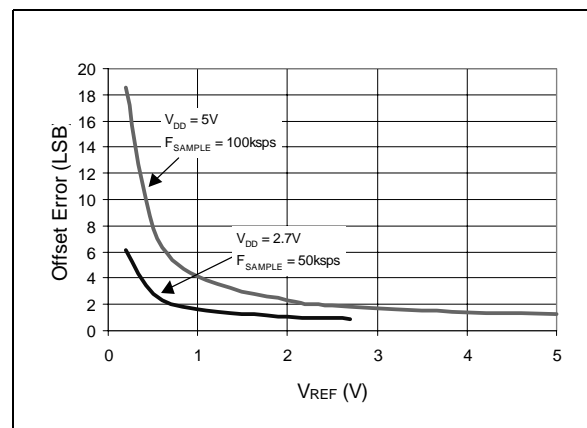
**FIGURE 2-14:** Differential Nonlinearity (DNL) vs. Temperature.



**FIGURE 2-17:** Differential Nonlinearity (DNL) vs. Temperature ( $V_{DD} = 2.7V$ ).

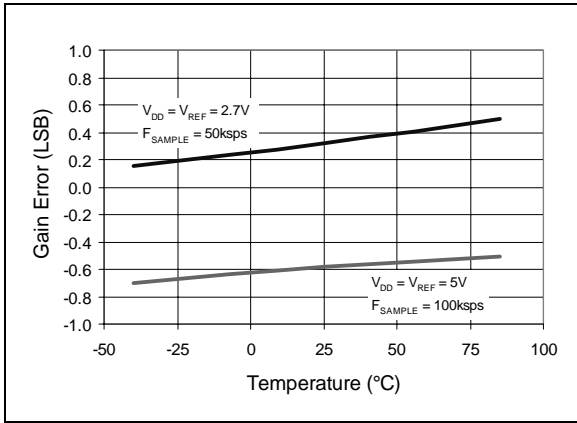


**FIGURE 2-15:** Gain Error vs.  $V_{REF}$ .

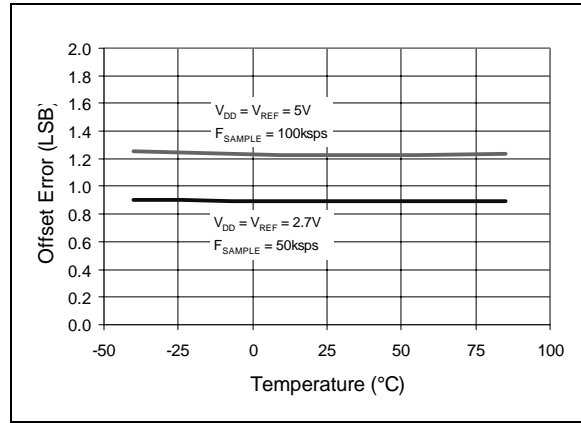


**FIGURE 2-18:** Offset Error vs.  $V_{REF}$ .

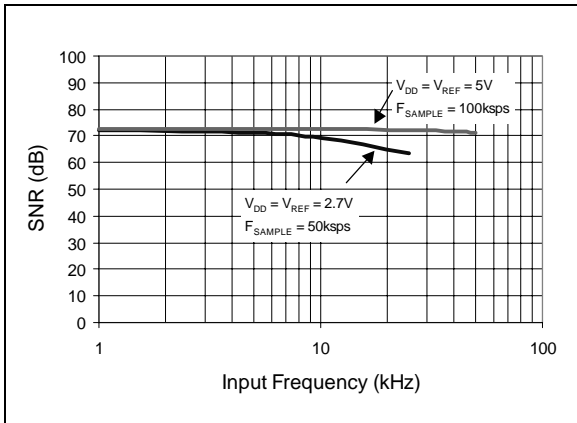
**Note:** Unless otherwise indicated,  $V_{DD} = V_{REF} = 5V$ ,  $V_{SS} = 0V$ ,  $f_{SAMPLE} = 100\text{kpsps}$ ,  $f_{CLK} = 16 \cdot f_{SAMPLE}$ ,  $T_A = 25^\circ\text{C}$



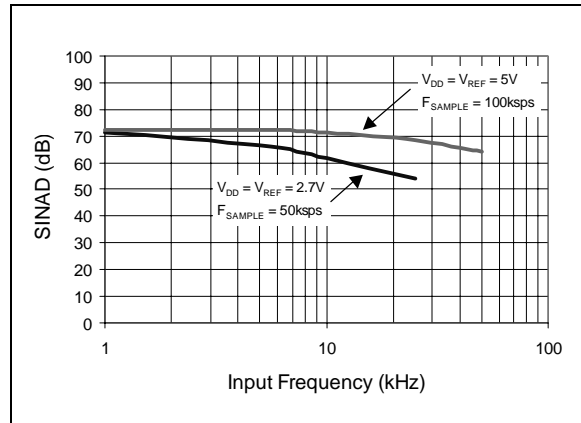
**FIGURE 2-19:** Gain Error vs. Temperature.



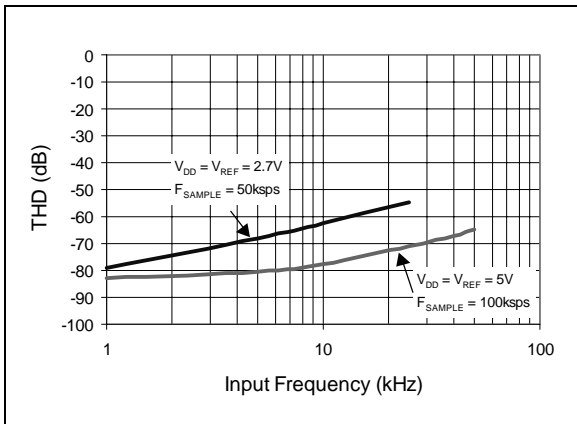
**FIGURE 2-22:** Offset Error vs. Temperature.



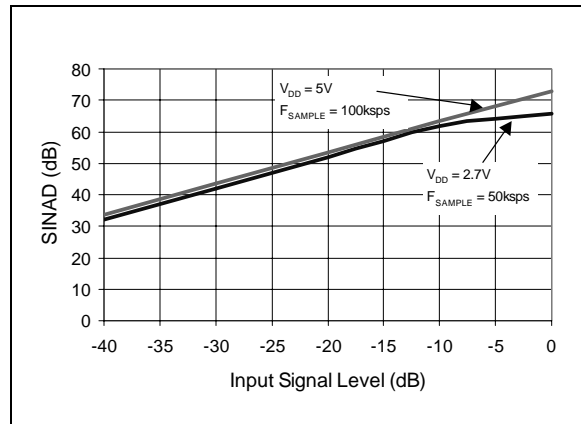
**FIGURE 2-20:** Signal to Noise Ratio (SNR) vs. Input Frequency.



**FIGURE 2-23:** Signal to Noise and Distortion (SINAD) vs. Input Frequency.



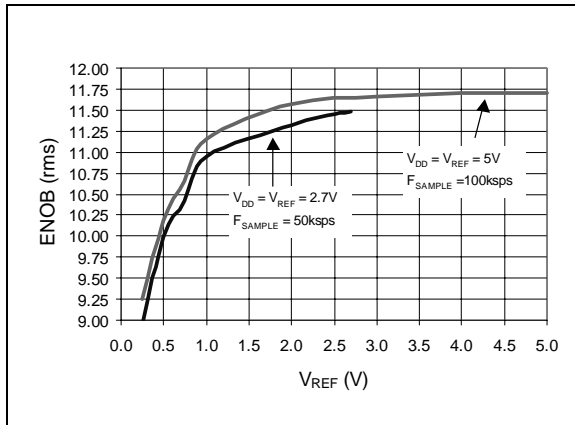
**FIGURE 2-21:** Total Harmonic Distortion (THD) vs. Input Frequency.



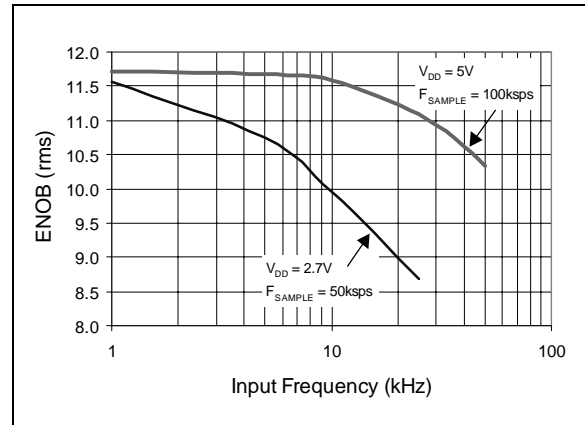
**FIGURE 2-24:** Signal to Noise and Distortion (SINAD) vs. Input Signal Level.



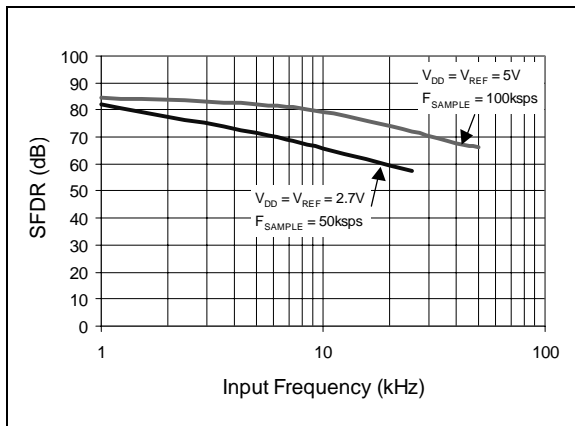
**Note:** Unless otherwise indicated,  $V_{DD} = V_{REF} = 5V$ ,  $V_{SS} = 0V$ ,  $f_{SAMPLE} = 100\text{kpsps}$ ,  $f_{CLK} = 16 \cdot f_{SAMPLE}$ ,  $T_A = 25^\circ\text{C}$



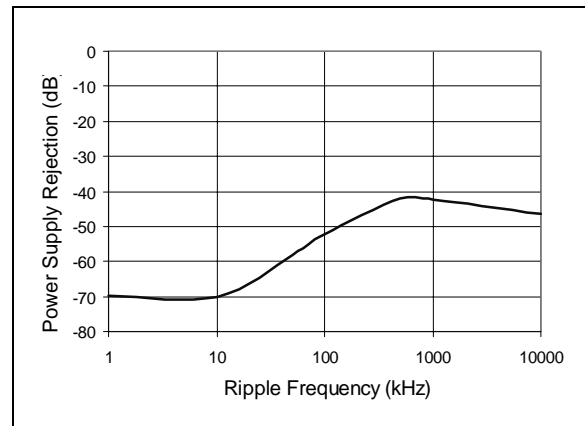
**FIGURE 2-25:** Effective Number of Bits (ENOB) vs.  $V_{REF}$ .



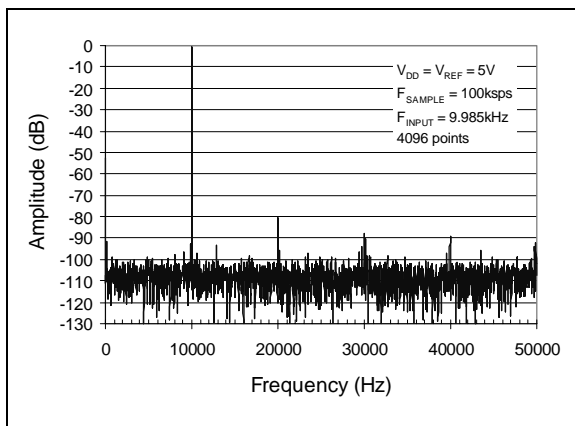
**FIGURE 2-28:** Effective Number of Bits (ENOB) vs. Input Frequency.



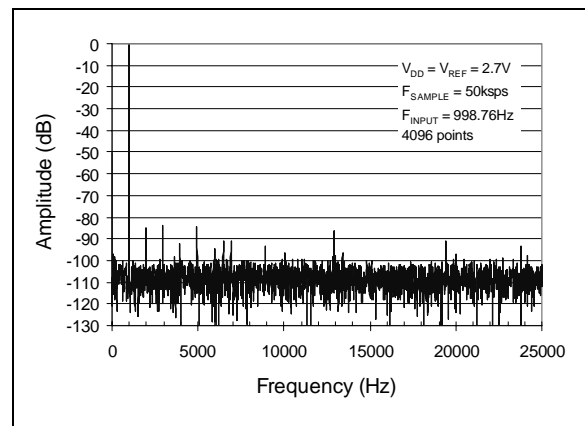
**FIGURE 2-26:** Spurious Free Dynamic Range (SFDR) vs. Input Frequency.



**FIGURE 2-29:** Power Supply Rejection (PSR) vs. Ripple Frequency.



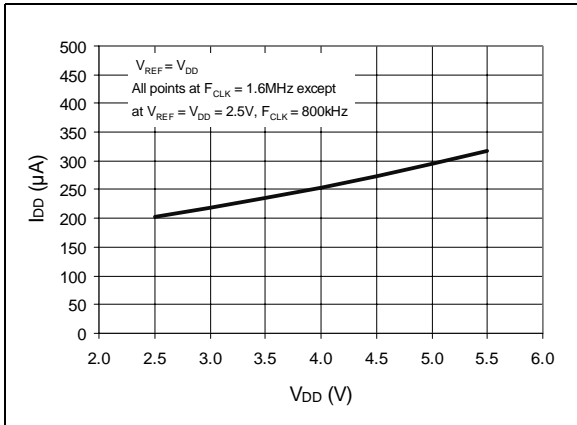
**FIGURE 2-27:** Frequency Spectrum of 10kHz input (Representative Part).



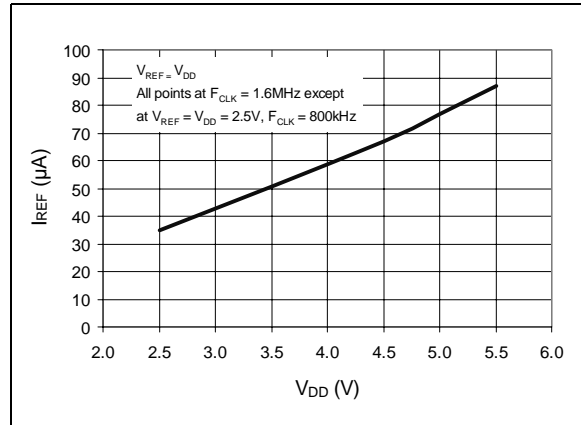
**FIGURE 2-30:** Frequency Spectrum of 1kHz input (Representative Part,  $V_{DD} = 2.7V$ ).

# MCP3201

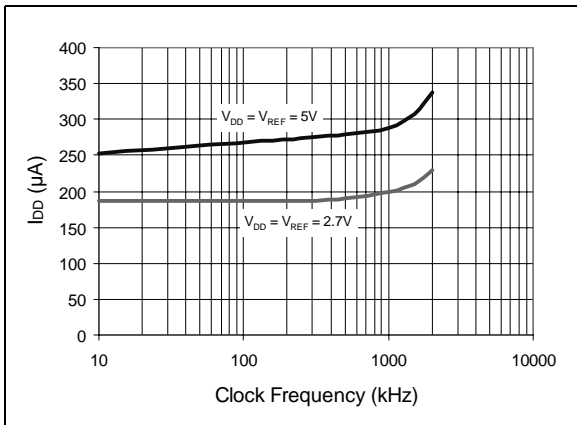
**Note:** Unless otherwise indicated,  $V_{DD} = V_{REF} = 5V$ ,  $V_{SS} = 0V$ ,  $f_{SAMPLE} = 100ksps$ ,  $f_{CLK} = 16 \cdot f_{SAMPLE}$ ,  $T_A = 25^\circ C$



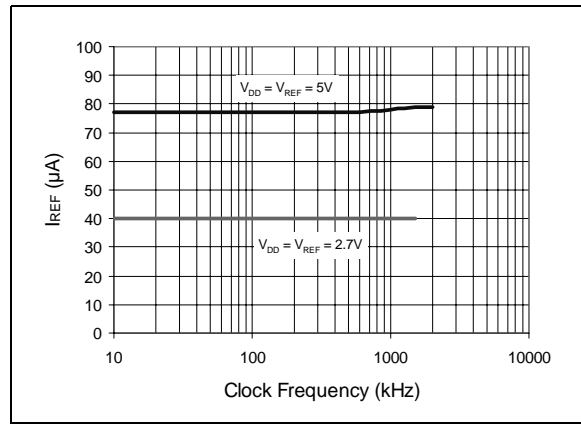
**FIGURE 2-31:**  $I_{DD}$  vs.  $V_{DD}$ .



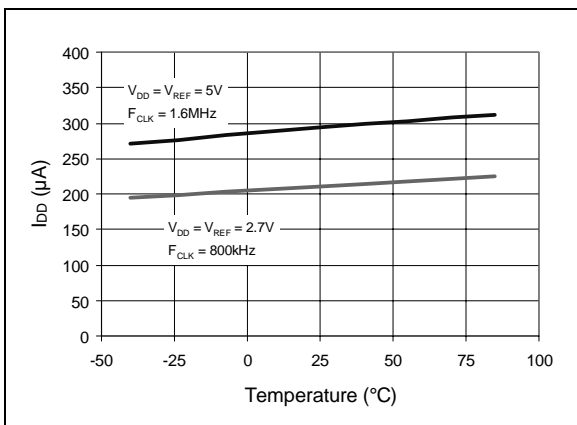
**FIGURE 2-34:**  $I_{REF}$  vs.  $V_{DD}$ .



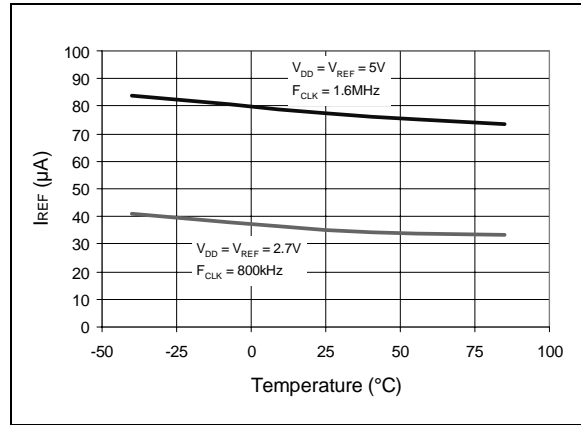
**FIGURE 2-32:**  $I_{DD}$  vs. Clock Frequency.



**FIGURE 2-35:**  $I_{REF}$  vs. Clock Frequency.

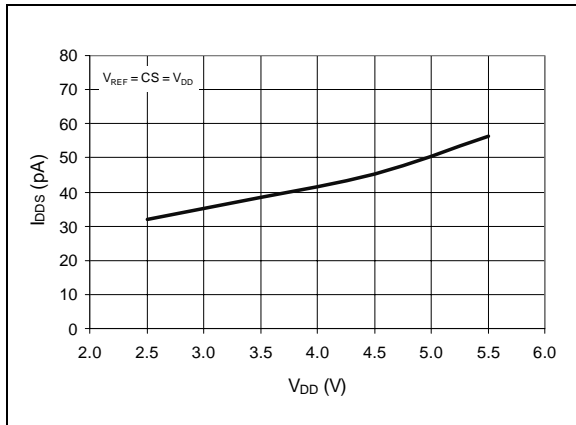


**FIGURE 2-33:**  $I_{DD}$  vs. Temperature.

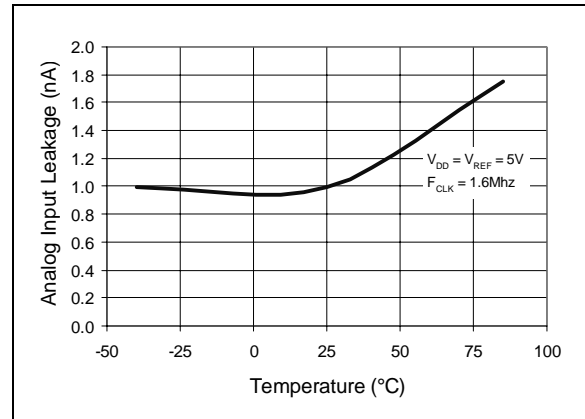


**FIGURE 2-36:**  $I_{REF}$  vs. Temperature.

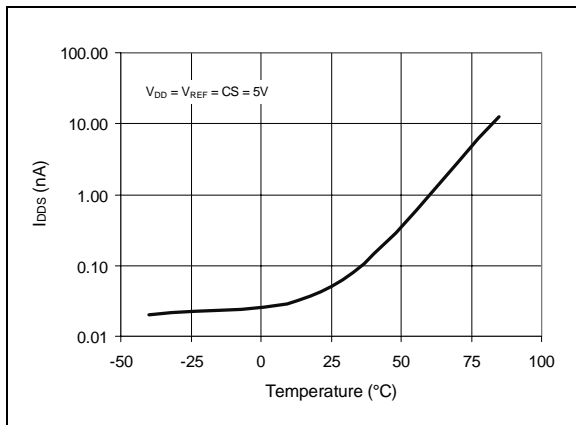
**Note:** Unless otherwise indicated,  $V_{DD} = V_{REF} = 5V$ ,  $V_{SS} = 0V$ ,  $f_{SAMPLE} = 100ksps$ ,  $f_{CLK} = 16 * f_{SAMPLE}$ ,  $T_A = 25^{\circ}C$



**FIGURE 2-37:**  $I_{DDs}$  vs.  $V_{DD}$ .



**FIGURE 2-39:** Analog Input Leakage Current vs. Temperature.



**FIGURE 2-38:**  $I_{DDs}$  vs. Temperature.

## 3.0 PIN DESCRIPTIONS

### 3.1 IN+

Positive analog input. This input can vary from  $IN-$  to  $V_{REF} + IN-$ .

### 3.2 IN-

Negative analog input. This input can vary  $\pm 100\text{mV}$  from  $V_{SS}$ .

### 3.3 CS/SHDN(Chip Select/Shutdown)

The  $\overline{CS}/SHDN$  pin is used to initiate communication with the device when pulled low and will end a conversion and put the device in low power standby when pulled high. The  $\overline{CS}/SHDN$  pin must be pulled high between conversions.

### 3.4 CLK (Serial Clock)

The SPI clock pin is used to initiate a conversion and to clock out each bit of the conversion as it takes place. See Section 6.2 for constraints on clock speed.

### 3.5 DOUT (Serial Data output)

The SPI serial data output pin is used to shift out the results of the A/D conversion. Data will always change on the falling edge of each clock as the conversion takes place.

## 4.0 DEVICE OPERATION

The MCP3201 A/D Converter employs a conventional SAR architecture. With this architecture, a sample is acquired on an internal sample/hold capacitor for 1.5 clock cycles starting on the first rising edge of the serial clock after CS has been pulled low. Following this sample time, the input switch of the converter opens and the device uses the collected charge on the internal sample and hold capacitor to produce a serial 12-bit digital output code. Conversion rates of 100ksps are possible on the MCP3201. See Section 6.2 for information on minimum clock rates. Communication with the device is done using a 3-wire SPI-compatible interface.

### 4.1 Analog Inputs

The MCP3201 provides a single pseudo-differential input. The  $IN+$  input can range from  $IN-$  to  $V_{REF}$  ( $V_{REF} + IN-$ ). The  $IN-$  input is limited to  $\pm 100\text{mV}$  from the  $V_{SS}$  rail. The  $IN-$  input can be used to cancel small signal common-mode noise which is present on both the  $IN+$  and  $IN-$  inputs.

For the A/D Converter to meet specification, the charge holding capacitor ( $C_{SAMPLE}$ ) must be given enough time to acquire a 12-bit accurate voltage level during the 1.5 clock cycle sampling period. The analog input model is shown in Figure 4-1.

In this diagram, it is shown that the source impedance ( $R_S$ ) adds to the internal sampling switch ( $R_{SS}$ ) impedance, directly affecting the time that is required to charge the capacitor ( $C_{SAMPLE}$ ). Consequently, a larger source impedance increases the offset, gain, and integral linearity errors of the conversion.

Ideally, the impedance of the signal source should be near zero. This is achievable with an operational amplifier such as the MCP601, which has a closed loop output impedance of tens of ohms. The adverse affects of higher source impedances are shown in Figure 4-2.

If the voltage level of  $IN+$  is equal to or less than  $IN-$ , the resultant code will be 000h. If the voltage at  $IN+$  is equal to or greater than  $\{[V_{REF} + (IN-)] - 1 \text{ LSB}\}$ , then the output code will be FFFh. If the voltage level at  $IN-$  is more than 1 LSB below  $V_{SS}$ , then the voltage level at the  $IN+$  input will have to go below  $V_{SS}$  to see the 000h output code. Conversely, if  $IN-$  is more than 1 LSB above  $V_{SS}$ , then the FFFh code will not be seen unless the  $IN+$  input level goes above  $V_{REF}$  level.

### 4.2 Reference Input

The reference input ( $V_{REF}$ ) determines the analog input voltage range and the LSB size, as shown below.

$$LSB \text{ Size} = \frac{V_{REF}}{4096}$$

As the reference input is reduced, the LSB size is reduced accordingly. The theoretical digital output code produced by the A/D Converter is a function of the analog input signal and the reference input as shown below.

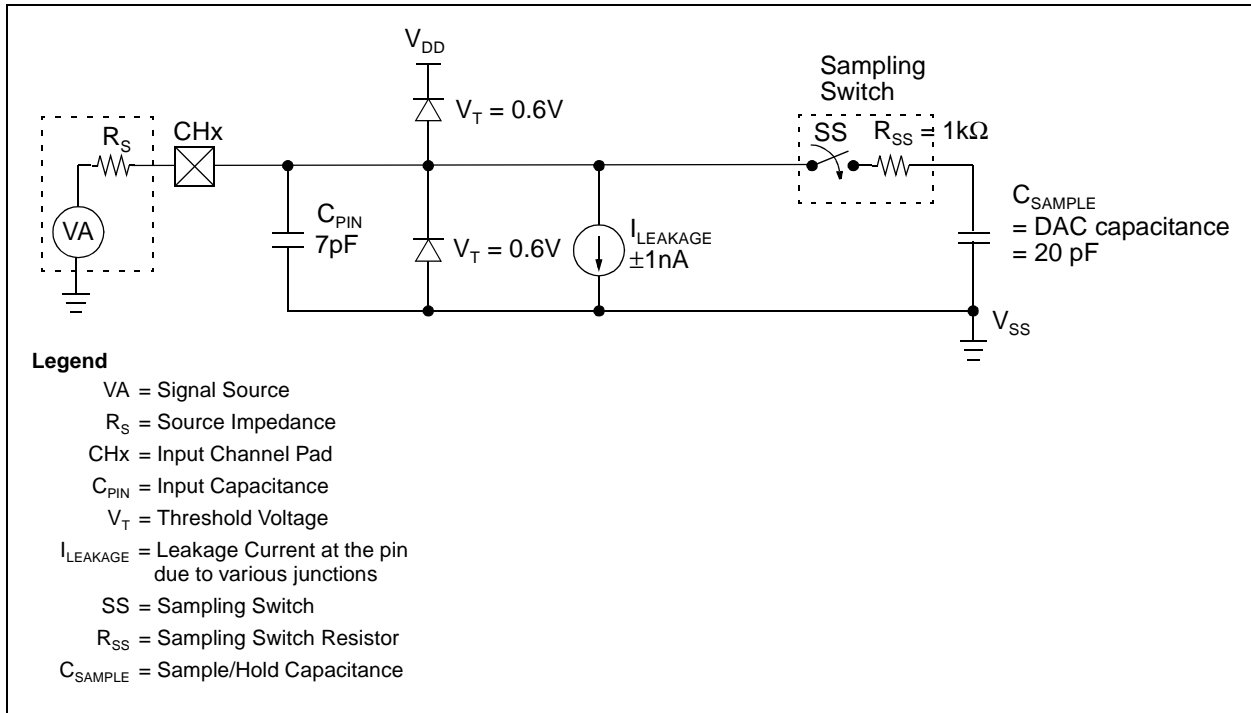
$$Digital \text{ Output Code} = \frac{4096 * V_{IN}}{V_{REF}}$$

where:

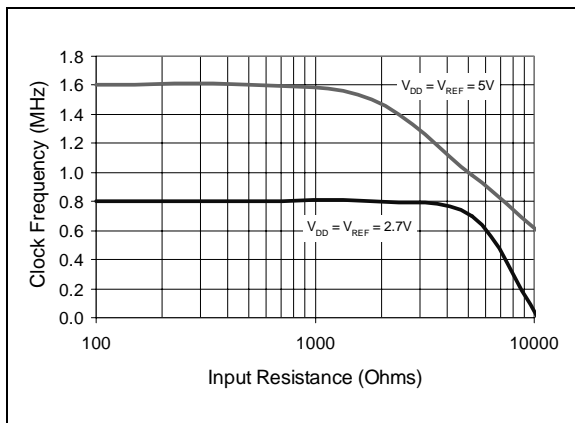
$$V_{IN} = \text{analog input voltage} = V(IN+) - V(IN-)$$

$$V_{REF} = \text{reference voltage}$$

When using an external voltage reference device, the system designer should always refer to the manufacturer's recommendations for circuit layout. Any instability in the operation of the reference device will have a direct effect on the operation of the A/D Converter.



**FIGURE 4-1:** Analog Input Model.



**FIGURE 4-2:** Maximum Clock Frequency vs. Input Resistance ( $R_S$ ) to maintain less than a 0.1 LSB deviation in INL from nominal conditions.

## 5.0 SERIAL COMMUNICATIONS

Communication with the device is done using a standard SPI-compatible serial interface. Initiating communication with the MCP3201 begins with the  $\overline{CS}$  going low. If the device was powered up with the  $\overline{CS}$  pin low, it must be brought high and back low to initiate communication. The device will begin to sample the analog input on the first rising edge after  $\overline{CS}$  goes low. The sample period will end in the falling edge of the second clock, at which time the device will output a low null bit. The next 12 clocks will output the result of the conver-

sion with MSB first, as shown in Figure 5-1. Data is always output from the device on the falling edge of the clock. If all 12 data bits have been transmitted and the device continues to receive clocks while the  $\overline{CS}$  is held low, the device will output the conversion result LSB first, as shown in Figure 5-2. If more clocks are provided to the device while  $\overline{CS}$  is still low (after the LSB first data has been transmitted), the device will clock out zeros indefinitely.

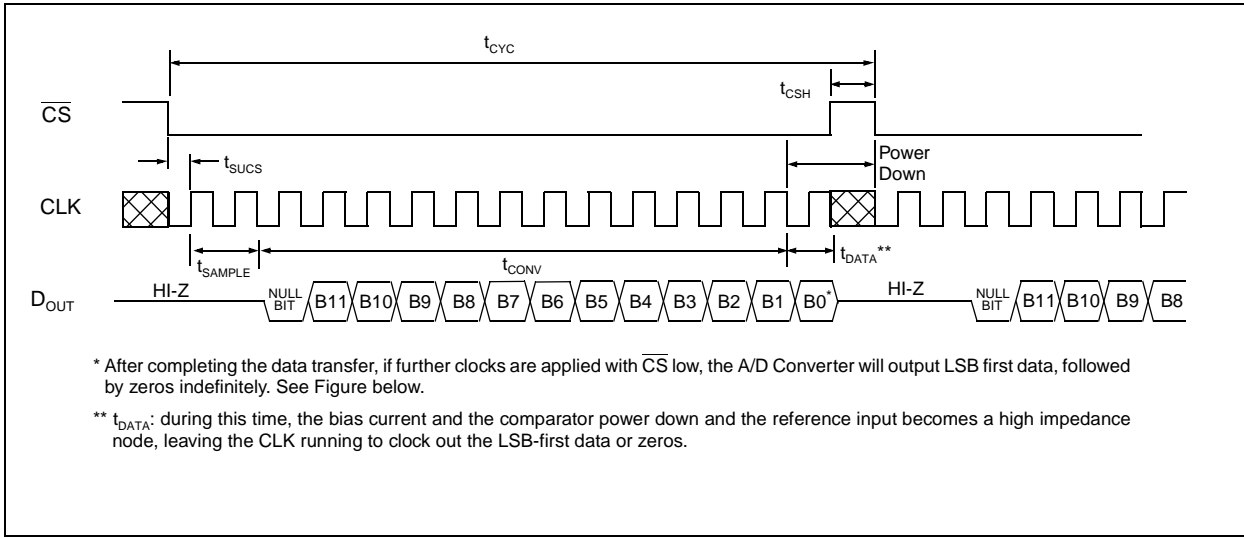


FIGURE 5-1: Communication with MCP3201 using MSB first Format.

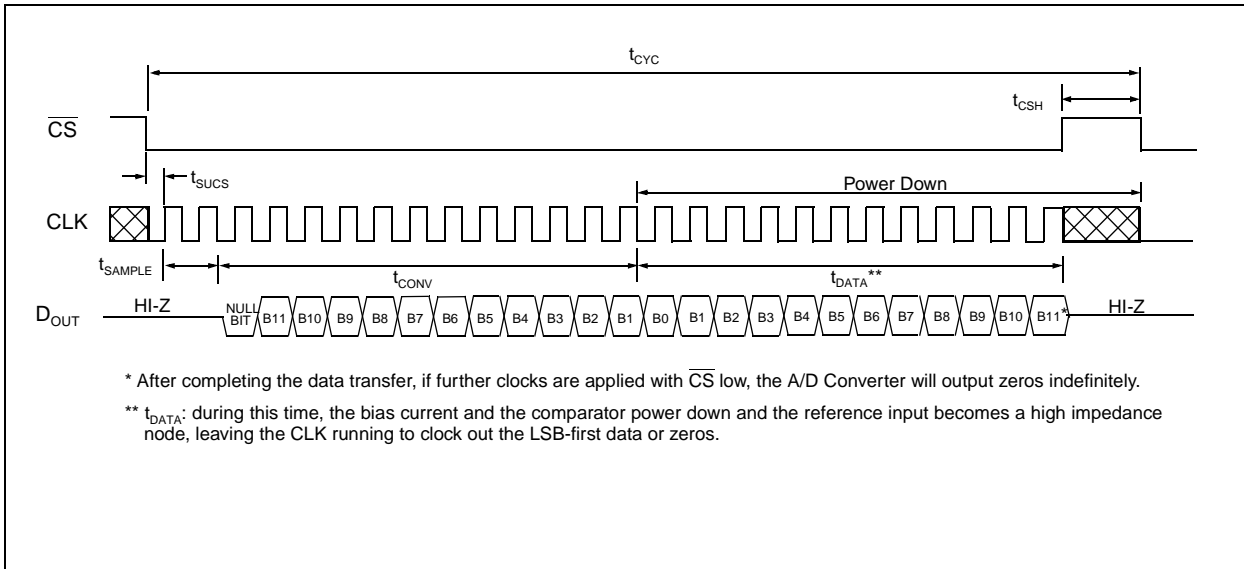


FIGURE 5-2: Communication with MCP3201 using LSB first Format.

## 6.0 APPLICATIONS INFORMATION

### 6.1 Using the MCP3201 with Microcontroller SPI Ports

With most microcontroller SPI ports, it is required to clock out eight bits at a time. If this is the case, it will be necessary to provide more clocks than are required for the MCP3201. As an example, Figure 6-1 and Figure 6-2 show how the MCP3201 can be interfaced to a microcontroller with a standard SPI port. Since the MCP3201 always clocks data out on the falling edge of clock, the MCU SPI port must be configured to match this operation. SPI Mode 0,0 (clock idles low) and SPI Mode 1,1 (clock idles high) are both compatible with the MCP3201. Figure 6-1 depicts the operation shown in SPI Mode 0,0, which requires that the CLK from the microcontroller idles in the 'low' state. As shown in the diagram, the MSB is clocked out of the A/D Converter on the falling edge of the third clock pulse. After the first eight clocks have been sent to the device, the microcontroller's receive buffer will contain two unknown bits

(the output is at high impedance for the first two clocks), the null bit and the highest order five bits of the conversion. After the second eight clocks have been sent to the device, the MCU receive register will contain the lowest order seven bits and the B1 bit repeated as the A/D Converter has begun to shift out LSB first data with the extra clock. Typical procedure would then call for the lower order byte of data to be shifted right by one bit to remove the extra B1 bit. The B7 bit is then transferred from the high order byte to the lower order byte, and then the higher order byte is shifted one bit to the right as well. Easier manipulation of the converted data can be obtained by using this method.

Figure 6-2 shows the same thing in SPI Mode 1,1 which requires that the clock idles in the high state. As with mode 0,0, the A/D Converter outputs data on the falling edge of the clock and the MCU latches data from the A/D Converter in on the rising edge of the clock.

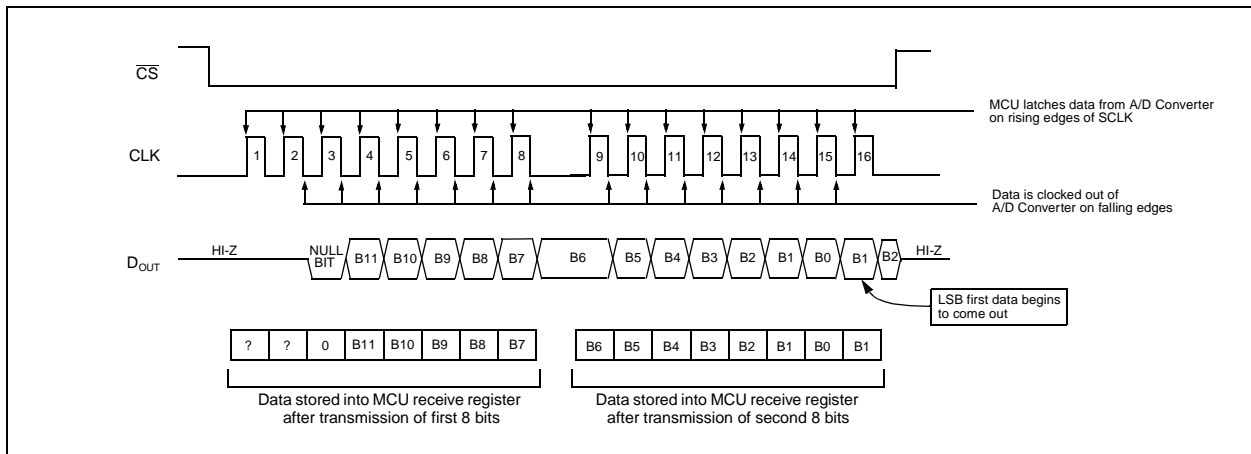


FIGURE 6-1: SPI Communication using 8-bit segments (Mode 0,0: SCLK idles low).

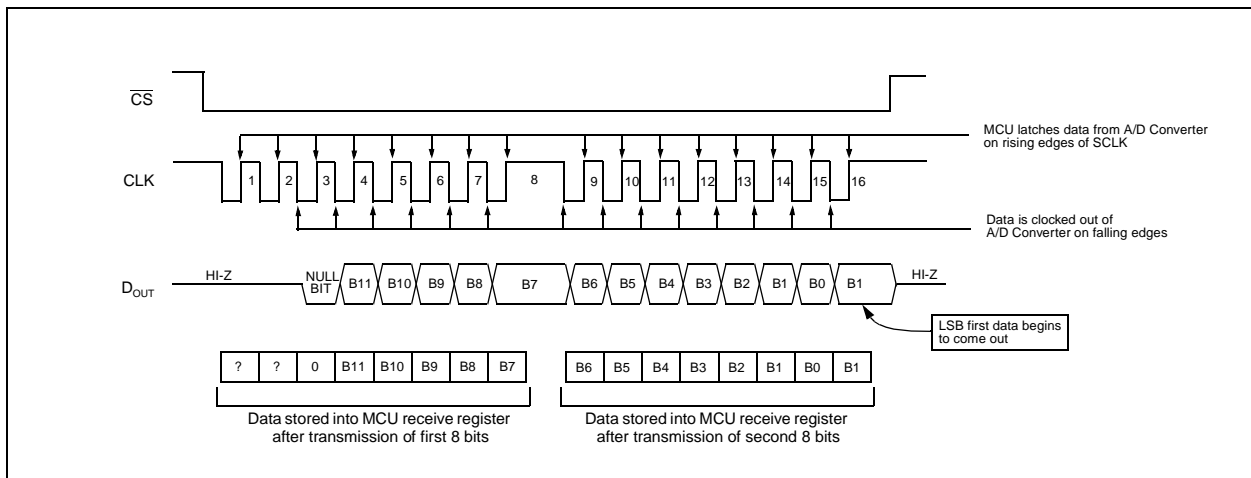


FIGURE 6-2: SPI Communication using 8-bit segments (Mode 1,1: SCLK idles high).

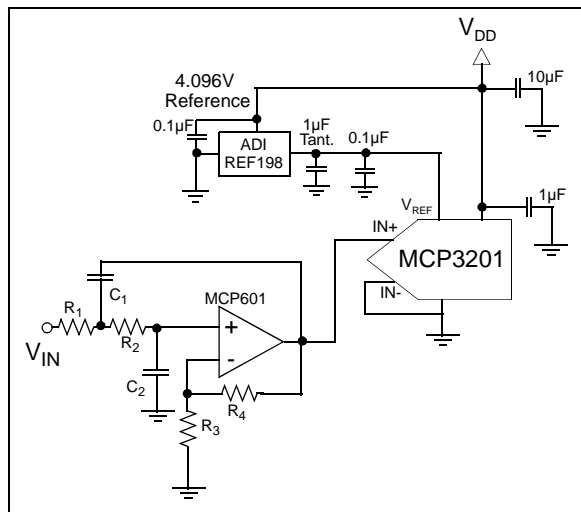
## 6.2 Maintaining Minimum Clock Speed

When the MCP3201 initiates the sample period, charge is stored on the sample capacitor. When the sample period is complete, the device converts one bit for each clock that is received. It is important for the user to note that a slow clock rate will allow charge to bleed off the sample cap while the conversion is taking place. At 85°C (worst case condition), the part will maintain proper charge on the sample capacitor for at least 1.2ms after the sample period has ended. This means that the time between the end of the sample period and the time that all 12 data bits have been clocked out must not exceed 1.2ms (effective clock frequency of 10kHz). Failure to meet this criteria may induce linearity errors into the conversion outside the rated specifications. It should be noted that during the entire conversion cycle, the A/D Converter does not require a constant clock speed or duty cycle, as long as all timing specifications are met.

## 6.3 Buffering/Filtering the Analog Inputs

If the signal source for the A/D Converter is not a low impedance source, it will have to be buffered or inaccurate conversion results may occur. See Figure 4-2. It is also recommended that a filter be used to eliminate any signals that may be aliased back into the conversion results. This is illustrated in Figure 6-3 where an op amp is used to drive the analog input of the MCP3201. This amplifier provides a low impedance source for the converter input and a low pass filter, which eliminates unwanted high frequency noise.

Low pass (anti-aliasing) filters can be designed using Microchip's interactive **FilterLab™** software. **FilterLab** will calculate capacitor and resistor values, as well as determine the number of poles that are required for the application. For more information on filtering signals, see the application note AN699 "Anti-Aliasing Analog Filters for Data Acquisition Systems."



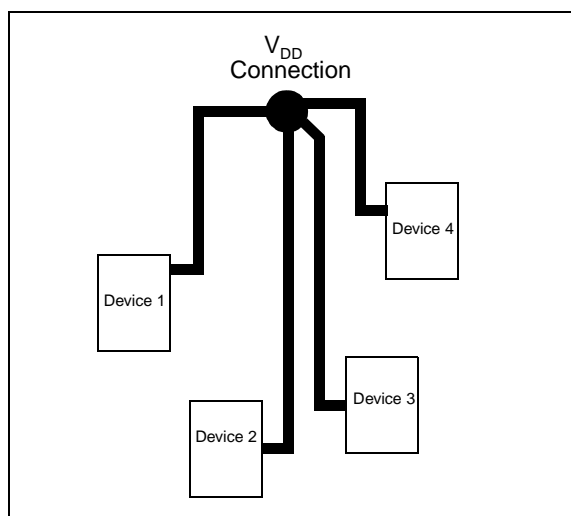
**FIGURE 6-3:** The MCP601 Operational Amplifier is used to implement a 2nd order anti-aliasing filter for the signal being converted by the MCP3201.

## 6.4 Layout Considerations

When laying out a printed circuit board for use with analog components, care should be taken to reduce noise wherever possible. A bypass capacitor should always be used with this device and should be placed as close as possible to the device pin. A bypass capacitor value of 1µF is recommended.

Digital and analog traces should be separated as much as possible on the board and no traces should run underneath the device or the bypass capacitor. Extra precautions should be taken to keep traces with high frequency signals (such as clock lines) as far as possible from analog traces.

Use of an analog ground plane is recommended in order to keep the ground potential the same for all devices on the board. Providing  $V_{DD}$  connections to devices in a "star" configuration can also reduce noise by eliminating current return paths and associated errors. See Figure 6-4. For more information on layout tips when using A/D Converter, refer to AN688 "Layout Tips for 12-Bit A/D Converter Applications".



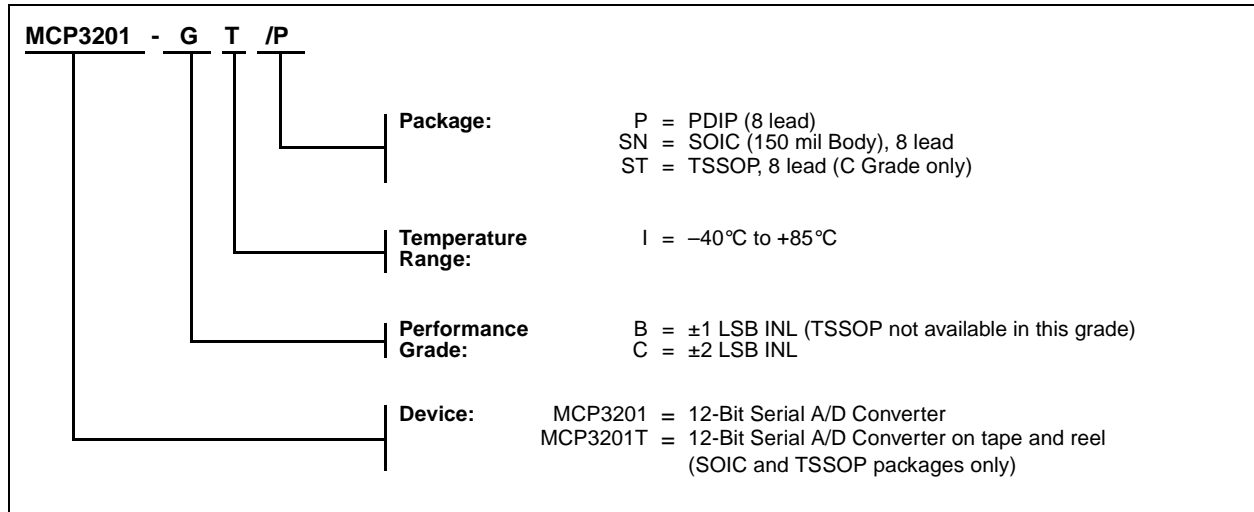
**FIGURE 6-4:**  $V_{DD}$  traces arranged in a 'Star' configuration in order to reduce errors caused by current return paths.

FilterLab is a trademark of Microchip Technology Inc. in the U.S.A and other countries. All rights reserved.



## MCP3201 PRODUCT IDENTIFICATION SYSTEM

To order or obtain information, e.g., on pricing or delivery, refer to the factory or the listed sales office.



### Sales and Support

#### Data Sheets

Products supported by a preliminary Data Sheet may have an errata sheet describing minor operational differences and recommended workarounds. To determine if an errata sheet exists for a particular device, please contact one of the following:

1. Your local Microchip sales office
2. The Microchip Corporate Literature Center U.S. FAX: (602) 786-7277. After September 1, 1999, (480) 786-7277
3. The Microchip Worldwide Site ([www.microchip.com](http://www.microchip.com))

Please specify which device, revision of silicon and Data Sheet (include Literature #) you are using.

#### New Customer Notification System

Register on our web site ([www.microchip.com/cn](http://www.microchip.com/cn)) to receive the most current information on our products.

# MCP3201

---

NOTES:

**NOTES:**



## WORLDWIDE SALES AND SERVICE

### AMERICAS

#### Corporate Office

Microchip Technology Inc.  
2355 West Chandler Blvd.  
Chandler, AZ 85224-6199  
Tel: 480-786-7200 Fax: 480-786-7277  
Technical Support: 480-786-7627  
Web Address: <http://www.microchip.com>

#### Atlanta

Microchip Technology Inc.  
500 Sugar Mill Road, Suite 200B  
Atlanta, GA 30350  
Tel: 770-640-0034 Fax: 770-640-0307

#### Boston

Microchip Technology Inc.  
5 Mount Royal Avenue  
Marlborough, MA 01752  
Tel: 508-480-9990 Fax: 508-480-8575

#### Chicago

Microchip Technology Inc.  
333 Pierce Road, Suite 180  
Itasca, IL 60143  
Tel: 630-285-0071 Fax: 630-285-0075

#### Dallas

Microchip Technology Inc.  
4570 Westgrove Drive, Suite 160  
Addison, TX 75248  
Tel: 972-818-7423 Fax: 972-818-2924

#### Dayton

Microchip Technology Inc.  
Two Prestige Place, Suite 150  
Miamisburg, OH 45342  
Tel: 937-291-1654 Fax: 937-291-9175

#### Detroit

Microchip Technology Inc.  
Tri-Atria Office Building  
32255 Northwestern Highway, Suite 190  
Farmington Hills, MI 48334  
Tel: 248-538-2250 Fax: 248-538-2260

#### Los Angeles

Microchip Technology Inc.  
18201 Von Karman, Suite 1090  
Irvine, CA 92612  
Tel: 949-263-1888 Fax: 949-263-1338

#### New York

Microchip Technology Inc.  
150 Motor Parkway, Suite 202  
Hauppauge, NY 11788  
Tel: 631-273-5305 Fax: 631-273-5335

#### San Jose

Microchip Technology Inc.  
2107 North First Street, Suite 590  
San Jose, CA 95131  
Tel: 408-436-7950 Fax: 408-436-7955

### AMERICAS (continued)

#### Toronto

Microchip Technology Inc.  
5925 Airport Road, Suite 200  
Mississauga, Ontario L4V 1W1, Canada  
Tel: 905-405-6279 Fax: 905-405-6253

### ASIA/PACIFIC

#### Hong Kong

Microchip Asia Pacific  
Unit 2101, Tower 2  
Metroplaza  
223 Hing Fong Road  
Kwai Fong, N.T., Hong Kong  
Tel: 852-2-401-1200 Fax: 852-2-401-3431

#### Beijing

Microchip Technology, Beijing  
Unit 915, 6 Chaoyangmen Bei Dajie  
Dong Erhuan Road, Dongcheng District  
New China Hong Kong Manhattan Building  
Beijing 100027 PRC  
Tel: 86-10-85282100 Fax: 86-10-85282104

#### India

Microchip Technology Inc.  
India Liaison Office  
No. 6, Legacy, Convent Road  
Bangalore 560 025, India  
Tel: 91-80-229-0061 Fax: 91-80-229-0062

#### Japan

Microchip Technology Intl. Inc.  
Benex S-1 6F  
3-18-20, Shinyokohama  
Kohoku-Ku, Yokohama-shi  
Kanagawa 222-0033 Japan  
Tel: 81-45-471-6166 Fax: 81-45-471-6122

#### Korea

Microchip Technology Korea  
168-1, Youngbo Bldg. 3 Floor  
Samsung-Dong, Kangnam-Ku  
Seoul, Korea  
Tel: 82-2-554-7200 Fax: 82-2-558-5934

#### Shanghai

Microchip Technology  
RM 406 Shanghai Golden Bridge Bldg.  
2077 Yan'an Road West, Hong Qiao District  
Shanghai, PRC 200335  
Tel: 86-21-6275-5700 Fax: 86 21-6275-5060

### ASIA/PACIFIC (continued)

#### Singapore

Microchip Technology Singapore Pte Ltd.  
200 Middle Road  
#07-02 Prime Centre  
Singapore 188980  
Tel: 65-334-8870 Fax: 65-334-8850

#### Taiwan, R.O.C

Microchip Technology Taiwan  
10F-1C 207  
Tung Hua North Road  
Taipei, Taiwan, ROC  
Tel: 886-2-2717-7175 Fax: 886-2-2545-0139

### EUROPE

#### United Kingdom

Arizona Microchip Technology Ltd.  
505 Eskdale Road  
Wokingham  
Berkshire, England RG41 5TU  
Tel: 44 118 921 5858 Fax: 44-118 921-5835

#### Denmark

Microchip Technology Denmark ApS  
Regus Business Centre  
Lautrup hof 1-3  
Ballerup DK-2750 Denmark  
Tel: 45 4420 9895 Fax: 45 4420 9910

#### France

Arizona Microchip Technology SARL  
Parc d'Activite du Moulin de Massy  
43 Rue du Saule Trapu  
Batiment A - 1er Etage  
91300 Massy, France  
Tel: 33-1-69-53-63-20 Fax: 33-1-69-30-90-79

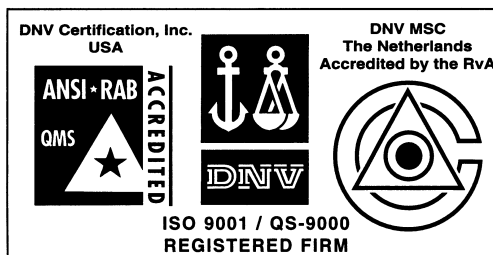
#### Germany

Arizona Microchip Technology GmbH  
Gustav-Heinemann-Ring 125  
D-81739 München, Germany  
Tel: 49-89-627-144 0 Fax: 49-89-627-144-44

#### Italy

Arizona Microchip Technology SRL  
Centro Direzionale Colleoni  
Palazzo Taurus 1 V. Le Colleoni 1  
20041 Agrate Brianza  
Milan, Italy  
Tel: 39-039-65791-1 Fax: 39-039-6899883

11/15/99



Microchip received QS-9000 quality system certification for its worldwide headquarters, design and water fabrication facilities in Chandler and Tempe, Arizona in July 1999. The Company's quality system processes and procedures are QS-9000 compliant for its PICmicro® 8-bit MCUs, KEELoc® code hopping devices, Serial EEPROMs and microperipheral products. In addition, Microchip's quality system for the design and manufacture of development systems is ISO 9001 certified.

All rights reserved. © 1999 Microchip Technology Incorporated. Printed in the USA. 11/99 Printed on recycled paper.

Information contained in this publication regarding device applications and the like is intended for suggestion only and may be superseded by updates. No representation or warranty is given and no liability is assumed by Microchip Technology Incorporated with respect to the accuracy or use of such information, or infringement of patents or other intellectual property rights arising from such use or otherwise. Use of Microchip's products as critical components in life support systems is not authorized except with express written approval by Microchip. No licenses are conveyed, implicitly or otherwise, under any intellectual property rights. The Microchip logo and name are registered trademarks of Microchip Technology Inc. in the U.S.A. and other countries. All rights reserved. All other trademarks mentioned herein are the property of their respective companies.