

# GENERAL INSTRUMENT

## VDE APPROVED NON-ZERO-CROSSING TRIACS

Optocouplers



**30 mA MCP3020/OZ\***  
**NON-ZERO-CROSSING 15 mA MCP3021/1Z**  
**10 mA MCP3022/2Z**

### PACKAGE DIMENSIONS

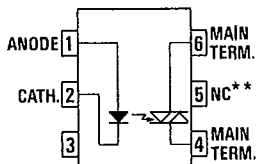
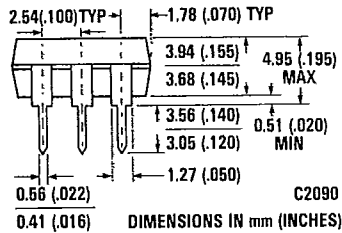
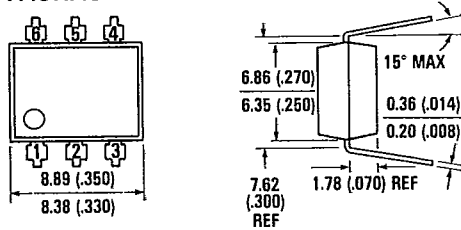

\*DO NOT CONNECT  
(TRIAC SUBSTRATE) C2081  
Equivalent Circuit

### DESCRIPTION

The MCP3020, MCP3021 and MCP3022 are optically isolated triac driver devices. These devices contain a GaAs infrared emitting diode and a light activated silicon bilateral switch, which functions like a triac. This series is designed for interfacing between electronic controls and power triacs to control resistive and inductive loads for 240 VAC operations.

### FEATURES

- Minimum commutating  $dv/dt$  is specified at  $0.1 V/\mu\text{sec}$
- Excellent  $I_{FT}$  stability—IR emitting diode has low degradation
- Pin for pin replacement for the MOC3020, MOC3021 and MOC3022
- High isolation voltage—minimum 7500 VAC peak
- Underwriters Laboratory (UL) recognized—File #E50151

### APPLICATIONS

- European applications for 240 VAC
- Triac driver
- Industrial controls
- Traffic lights
- Vending machines
- Motor control
- Solid state relay

\*Not Recommended  
For New Designs

### ABSOLUTE MAXIMUM RATINGS

**TOTAL PACKAGE**  
Storage temperature . . . . .  $-55^{\circ}\text{C}$  to  $150^{\circ}\text{C}$   
Operating temperature . . . . .  $-40^{\circ}\text{C}$  to  $100^{\circ}\text{C}$   
Lead temperature  
(Soldering, 10 sec) . . . . .  $260^{\circ}\text{C}$   
Total package power dissipation @  $25^{\circ}\text{C}$   
(LED plus detector) . . . . . 330 mW  
Derate linearly from  $25^{\circ}\text{C}$  . . . . .  $4.0 \text{ mW}/^{\circ}\text{C}$   
Surge Isolation voltage . . . . . 7500 VAC Peak

### INPUT DIODE

Forward DC current . . . . . 60 mA  
Reverse voltage . . . . . 3 V  
Peak forward current  
(1  $\mu\text{s}$  pulse, 300 pps) . . . . . 3.0 A  
Power dissipation  $25^{\circ}\text{C}$  ambient . . . . . 100 mW  
Derate linearly from  $25^{\circ}\text{C}$  . . . . .  $1.33 \text{ mW}/^{\circ}\text{C}$

### OUTPUT DRIVER

Off-State Output Terminal Voltage . . . . . 400 Volts  
On-State RMS Current  $T_A = 25^{\circ}\text{C}$  . . . . . 100 mA  
(Full Cycle, 50 to 60 Hz)  $T_A = 70^{\circ}\text{C}$  . . . . . 50 mA  
Peak Nonrepetitive Surge Current . . . . . 1.2 A  
(PW = 10 ms, DC = 10%)  
Total Power Dissipation @  $T_A = 25^{\circ}\text{C}$  . . . . . 300 mW  
Derate above  $25^{\circ}\text{C}$  . . . . .  $4.0 \text{ mW}/^{\circ}\text{C}$

**MCP3020/OZ MCP3021/1Z MCP3022/2Z**

3890128 GENL INSTR, OPTOELEK

88D 02946

DT-41-87

**ELECTRO-OPTICAL CHARACTERISTICS (25°C Temperature Unless Otherwise Specified)**

TRANSFER CHARACTERISTICS								
	CHARACTERISTIC	SYMBOL	MIN.	TYP.	MAX.	UNITS	TEST CONDITIONS	
DC	LED Trigger Current (Current Required to latch output)	MCP3020 MCP3021 MCP3022	$I_{FT}$	—	15 8 5	30 15 10	mA	Main terminal voltage = 3.0 V
	Holding Current		$I_H$	—	200	—	$\mu$ A	Either direction
dv/dt RATING	Critical Rate of Rise of Off-State Voltage		$dv/dt$	—	15	—	V/ $\mu$ s	Static dv/dt, $T_A = 85^\circ\text{C}$ (see Figure 4)
	Critical Rate of Rise of Commutating Voltage		$dv/dt$	0.1	0.2	—	V/ $\mu$ S	Commutating dv/dt $I_{LOAD} = 15$ mA (see Figure 5)
ISOLATION	Isolation Voltage		$V_{iso}$	5300			$V_{ACRMS}$	Relative humidity < 50%, $I_{I-O} < 10$ $\mu$ A, 5 seconds
			$V_{iso}$	7500			$V_{ACPEAK}$	Relative humidity < 50%, $I_{I-O} < 10$ $\mu$ A, 5 seconds
	Isolation resistance		$R_{iso}$	$10^{11}$			ohms	$V_{I-O} = 500$ VDC
	Isolation capacitance		$C_{iso}$		0.5		pF	$f = 1$ MHz

INDIVIDUAL COMPONENT CHARACTERISTICS								
	CHARACTERISTIC	SYMBOL	MIN.	TYP.	MAX.	UNITS	TEST CONDITIONS	
INPUT DIODE	Forward voltage		$V_F$	1.3	1.50	V	$I_F = 30$ mA	
	Forward voltage temp. coefficient			-1.8		mV/ $^\circ\text{C}$		
	Reverse breakdown voltage		$BV_R$	3.0	25	V	$I_R = 10$ $\mu$ A	
	Junction capacitance		$C_J$		50	pF	$V_F = 0$ V, $f = 1$ MHz	
					65	pF	$V_F = 1$ V, $f = 1$ MHz	
	Reverse leakage current		$I_R$	.35	10	$\mu$ A	$V_R = 3.0$ V	
OUTPUT DETECTOR	Peak Blocking Current, Either Direction		$I_{DRM}$	—	10	100	nA	$V_{DRM} = 400$ V, Note 1
	Peak On-State Voltage, Either Direction		$V_{TM}$	—	2.0	3.0	Volts	$I_{TM} = 100$ mA Peak
	Note 1. Test voltage must be applied within dv/dt rating.							

TYPICAL ELECTRICAL CHARACTERISTIC CURVES (25°C Free Air Temperature Unless Otherwise Specified)

Optocouplers

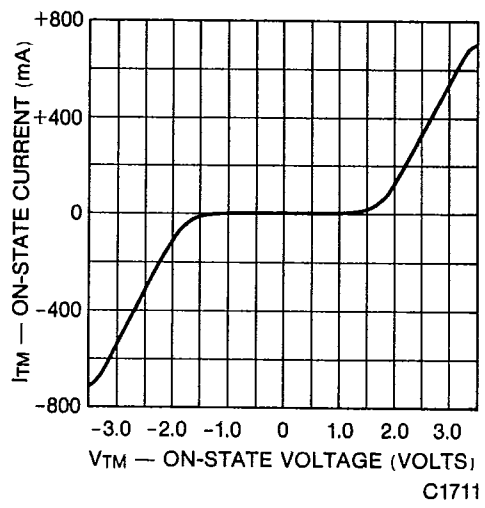

Fig. 1 On-State Characteristics

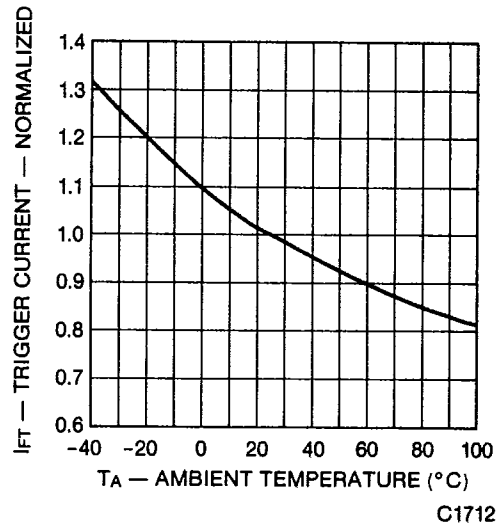
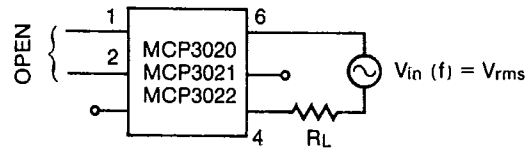

Fig. 2 Trigger Current vs. Temperature

TEST CIRCUITS FOR dV/dt MEASUREMENTS



$$\frac{dV}{dt} = \omega V_{pack} = 2\pi f \times 1.414 V_{rms}$$

$$= 8.88 f V_{rms}$$

Fig. 3. Static dV/dt

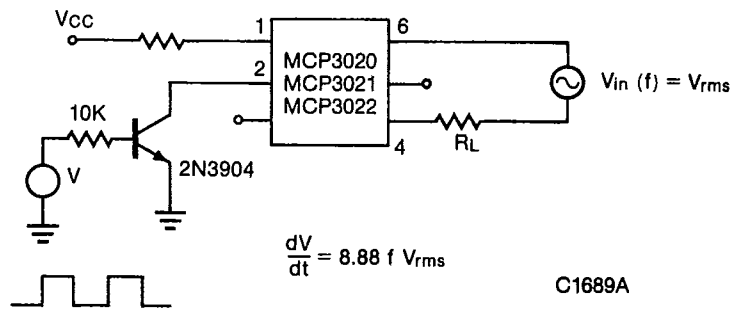

$$\frac{dV}{dt} = 8.88 f V_{rms}$$

C1689A

Fig. 4. Commutating dV/dt