

Single 1A, 1.4 MHz Synchronous Buck Regulator

Features

- Fixed Switching Frequency: 1.4 MHz
- Input Operating Voltage Range: 2.7V to 5.5V
- Integrated Buck and Synchronous Switches
- Adjustable-Output Voltage Range: 0.8V to 5.0V
- 100% Duty Cycle Capable for Low Input Voltage
- Continuous Output Current Capability: 1A
- Shutdown Control with $I_Q < 0.01 \mu\text{A}$ (Typ.)
- Integrated Soft-Start Feature
- Integrated Undervoltage Lockout (UVLO) Protection
- Integrated Overtemperature Protection
- Fast Dynamic Response to Line and Load Steps
- Small, 8-Pin DFN and MSOP Packages
- Operating Temperature Range: -40°C to $+85^\circ\text{C}$

Applications

- Network Interface Cards
- Portable Computers
- Set-Top Boxes
- DSL Modems and Routers
- USB-Powered Devices
- GBIC Modules
- High-Speed Data System Bus Termination
- Medical Instruments
- Cellular/GSM/PHS Phones
- +5V or +3.3V Distributed Voltages

Description

The MCP1612 is a 1A, 1.4 MHz, fully-integrated, current mode-controlled, synchronous buck regulator. The MCP1612 is packaged in the 8-pin MSOP and space-saving, 3x3 DFN packages. The DFN package also provides a lower thermal resistance package option for high-power, high ambient temperature applications. With an input operating range from 2.7V to 5.5V, the MCP1612 is ideal for applications that are powered by one single-cell Li-Ion, 2- to 3-cell NiMH, NiCd or alkaline sources.

The output voltage of the MCP1612 is easily set over the range of 0.8V to 5.0V by using an external resistor divider. The external inductor and output capacitor size are minimized due to an internally-fixed, 1.4 MHz clock being used to set the switching frequency. The fixed clock allows for continuous, fixed-frequency PWM operation over the full load range.

The MCP1612 is designed to provide fast dynamic response to sudden changes in input voltage and load current to minimize the necessary amount of external output capacitance.

The MCP1612 can be used with ceramic, tantalum or aluminum electrolytic output capacitors. Ceramic capacitors with values as low as $4.7 \mu\text{F}$ can be used to keep the output ripple voltage low. For applications that require better load step performance, the value of the output capacitor can be increased to $47 \mu\text{F}$.

Additional features integrated into the MCP1612 include shutdown capability, soft-start, UVLO, overcurrent and overtemperature protection.

Package Types

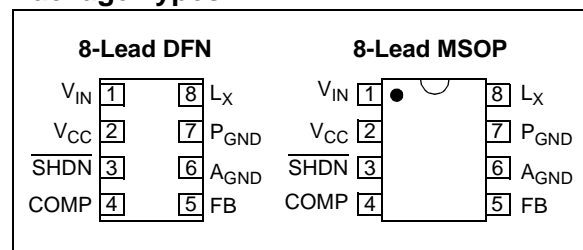

MCP1612

Functional Block Diagram

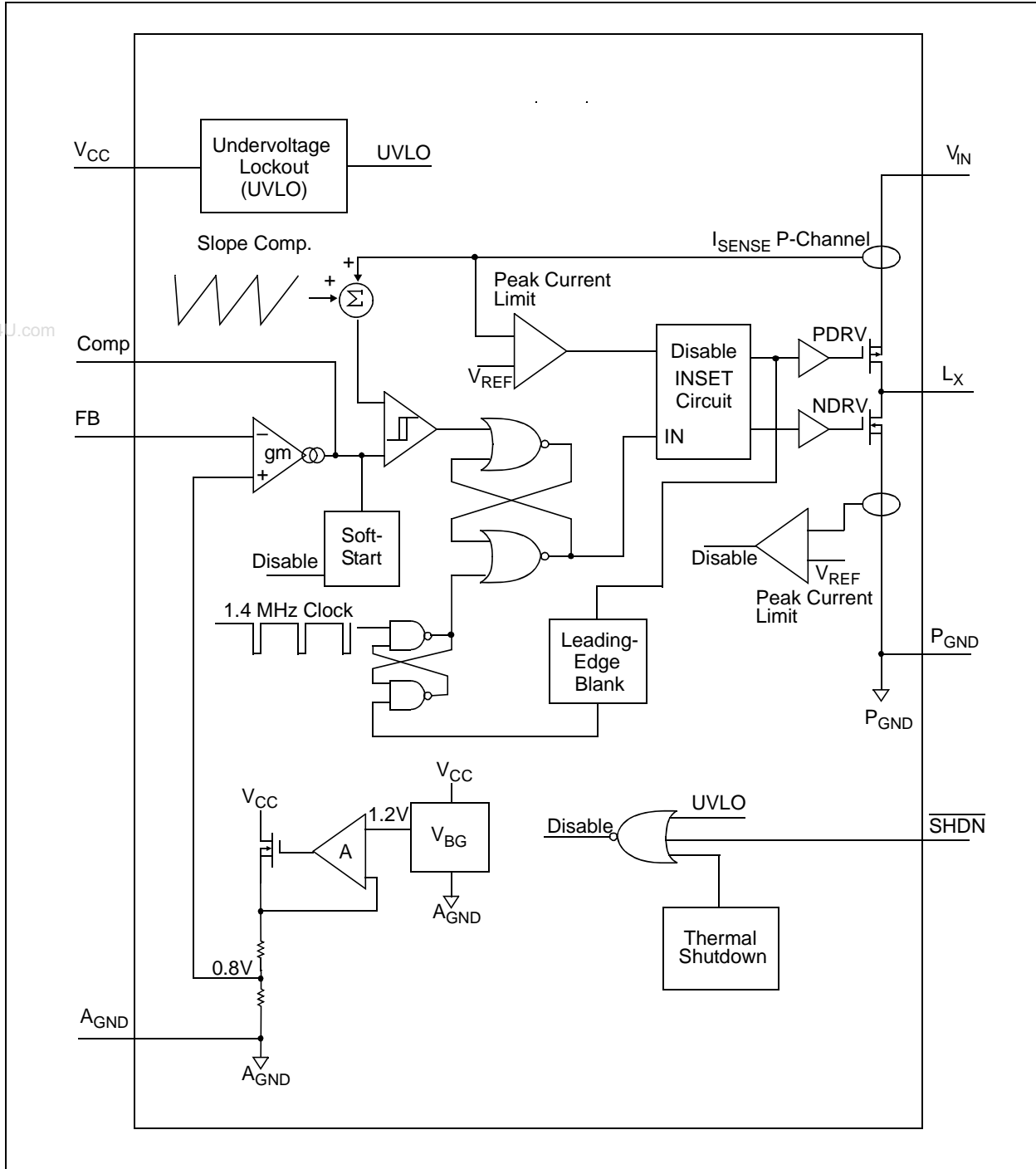

Typical Application Circuit

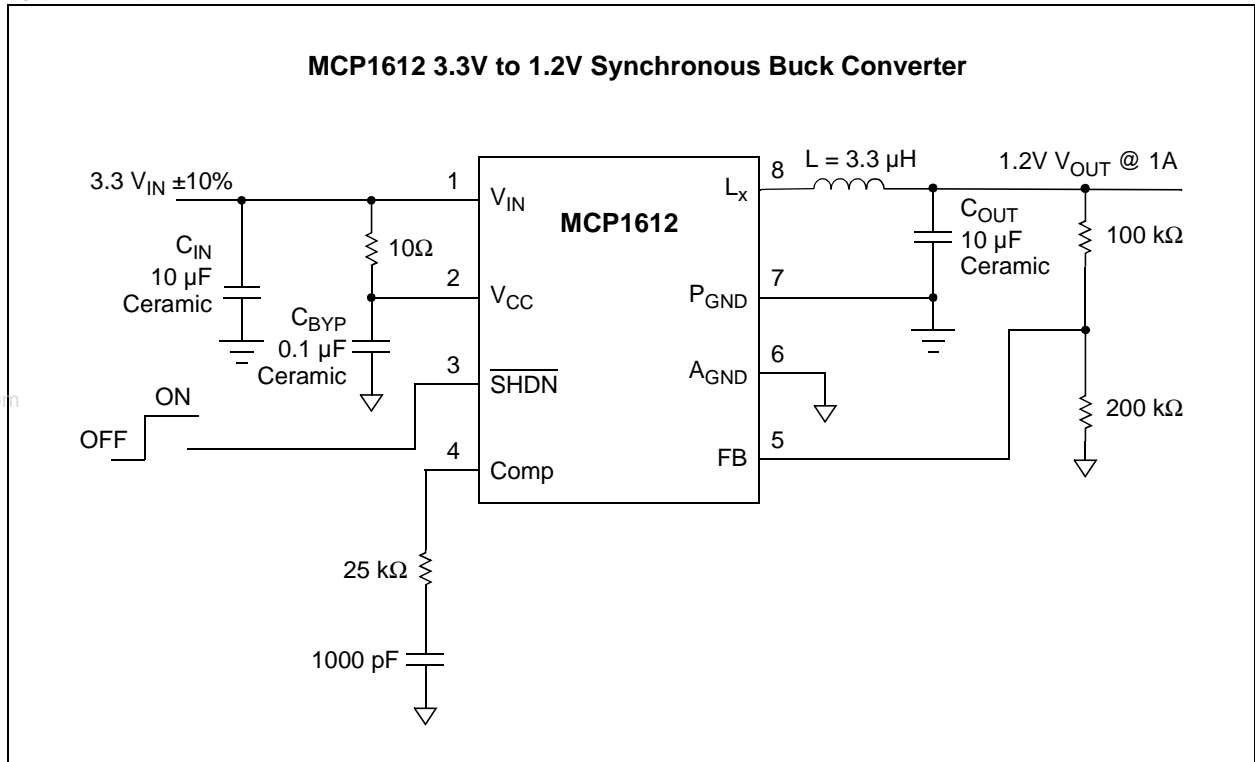

MCP1612

1.0 ELECTRICAL CHARACTERISTICS

Absolute Maximum Ratings †

$V_{IN} - A_{GND}$	6.0V
(SHDN, FB, V_{CC} , Comp)	($A_{GND} - 0.3V$) to ($V_{IN} + 0.3V$)
L_X to P_{GND}	-0.3V to ($V_{IN} + 0.3V$)
P_{GND} to A_{GND}	-0.3V to +0.3V
Output Short Circuit Current	Continuous
Storage temperature	-65°C to +150°C
Ambient Temp. with Power Applied	-40°C to +85°C
Operating Junction Temperature	-40°C to +125°C
ESD protection on all pins (HBM)	4 kV
ESD protection on all pins (MM)	300V

† **Notice:** Stresses above those listed under “Maximum Ratings” may cause permanent damage to the device. This is a stress rating only and functional operation of the device at those or any other conditions above those indicated in the operational listings of this specification is not implied. Exposure to maximum rating conditions for extended periods may affect device reliability.

DC CHARACTERISTICS

Electrical Specifications: Unless otherwise noted, $V_{IN} = V_{CC} = V_{SHDN} = 3.3V$, $V_{OUT} = 1.8V$, $C_{IN} = C_{OUT} = 10 \mu F$, $L = 3.3 \mu H$, $I_{LOAD} = 100 \text{ mA}$, $T_A = +25^\circ C$. Boldface specifications apply over the T_A range of $-40^\circ C$ to $+85^\circ C$.						
Parameters	Sym	Min	Typ	Max	Units	Conditions
Input Voltage						
Input Operating Voltage	V_{IN}	2.7	—	5.5	V	
Input Shutdown Current	$I(V_{IN})$	—	0.01	1	μA	Shutdown mode ($\overline{SHDN} = GND$)
Input Quiescent Current	$I(V_{IN})$	—	5	7	mA	$I_{LOAD} = 0 \text{ mA}$
Oscillator Characteristics						
Internal Oscillator Frequency	F_{OSC}	1.2	1.4	1.6	MHz	
Internal Power Switches						
R_{DSon} P-Channel	R_{DSon-P}	—	300	—	$m\Omega$	$I_p = 250 \text{ mA}$
R_{DSon} N-Channel	R_{DSon-N}	—	300	—	$m\Omega$	$I_N = 250 \text{ mA}$
L_X Pin Leakage Current	I_{LX}	-1	—	1	μA	$\overline{SHDN} = 0V$, $V_{IN} = 5.5V$, $L_X = 0V$, $L_X = 5.5V$
Positive Current Limit Threshold	$+I_{LX(MAX)}$	—	2.3	—	A	
Negative Current Limit Threshold	$-I_{LX(MAX)}$	—	-1.4	—	A	
Feedback Characteristics						
Transconductance from FB to COMP	g_m	35	62	90	$\mu A/V$	
Output Voltage						
Output Voltage Range	V_{OUT}	0.8	—	V_{IN}	V	
Reference Feedback Voltage	V_{FB}	0.78	0.8	0.82	V	
Feedback Input Bias Current	I_{VFB}	—	1	—	nA	
Line Regulation	$V_{LINE-REG}$	—	0.15	0.5	%/V	$V_{IN} = 2.7V$ to $5.5V$, $I_{LOAD} = 100 \text{ mA}$
Load Regulation	$V_{LOAD-REG}$	—	0.25	—	%	$V_{IN} = 4.2V$, $I_{LOAD} = 100 \text{ mA}$ to $1A$

- Note 1:** The integrated MOSFET switches have an integral diode from the L_X pin to V_{IN} and from L_X to P_{GND} . In cases where these diodes are forward-biased, the package power dissipation limits must be adhered to. Thermal protection is not able to regulate the junction temperature for these cases.
- Note 2:** UVLO is specified for a falling V_{IN} . Once the UVLO is activated, the $UVLO_{HYS}$ must be overcome before the device will return to operation.

DC CHARACTERISTICS (CONTINUED)

Electrical Specifications: Unless otherwise noted, $V_{IN} = V_{CC} = V_{SHDN} = 3.3V$, $V_{OUT} = 1.8V$, $C_{IN} = C_{OUT} = 10 \mu F$, $L = 3.3 \mu H$, $I_{LOAD} = 100 \text{ mA}$, $T_A = +25^\circ C$. **Boldface** specifications apply over the T_A range of $-40^\circ C$ to $+85^\circ C$.

Parameters	Sym	Min	Typ	Max	Units	Conditions
Protection Features						
Undervoltage Lockout	UVLO	2.4	2.55	2.7	V	Note 2
Undervoltage Lockout Hysteresis	UVLO-HYS	—	200	—	mV	
Thermal Shutdown	T _{SHD}	—	160	—	°C	Note 1
Thermal Shutdown Hysteresis	T _{SHD-HYS}	—	9	—	°C	
Interface Signal (SHDN)						
Logic-High Input	V _{IN-HIGH}	45	—	—	% of V _{IN}	
Logic-Low Input	V _{IN-LOW}	—	—	15	% of V _{IN}	

- Note 1:** The integrated MOSFET switches have an integral diode from the L_X pin to V_{IN} and from L_X to P_{GND}. In cases where these diodes are forward-biased, the package power dissipation limits must be adhered to. Thermal protection is not able to regulate the junction temperature for these cases.
- Note 2:** UVLO is specified for a falling V_{IN}. Once the UVLO is activated, the UVLO-HYS must be overcome before the device will return to operation.

TEMPERATURE SPECIFICATIONS

Electrical Specifications: $V_{IN} = 3.0V$ to $5.5V$, $F_{OSC} = 1 \text{ MHz}$ with 10% Duty Cycle, $C_{IN} = 0.1 \mu F$, $T_A = -40^\circ C$ to $+125^\circ C$.

Parameters	Sym	Min	Typ	Max	Units	Conditions
Temperature Ranges						
Storage Temperature Range	T _A	-65	—	+150	°C	Continuous
Maximum Junction Temperature	T _J	—	—	+150	°C	Transient Only
Operating Junction Temperature Range	T _A	-40	—	+125	°C	Continuous Operation
Thermal Package Resistances						
Thermal Resistance, 8L-MSOP	θ _{JA}	—	208	—	°C/W	Typical 4-layer board interconnecting vias
Thermal Resistance, 8L-DFN	θ _{JA}	—	41	—	°C/W	Typical 4-layer board interconnecting vias

MCP1612

2.0 TYPICAL PERFORMANCE CURVES

Note: The graphs and tables provided following this note are a statistical summary based on a limited number of samples and are provided for informational purposes only. The performance characteristics listed herein are not tested or guaranteed. In some graphs or tables, the data presented may be outside the specified operating range (e.g., outside specified power supply range) and therefore outside the warranted range.

Note: Unless otherwise indicated, $V_{IN} = V_{CC} = V_{SHDN} = 3.3V$, $C_{OUT} = C_{IN} = 10 \mu F$, $L = 3.3 \mu H$, $I_{LOAD} = 100 \text{ mA}$, $T_A = +25^\circ C$. **Boldface** specifications apply over the T_A range of $-40^\circ C$ to $+85^\circ C$.

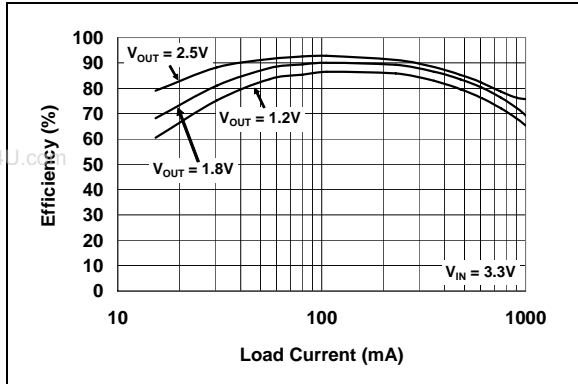

FIGURE 2-1: Efficiency vs. Load Current, $V_{IN} = 3.3V$.

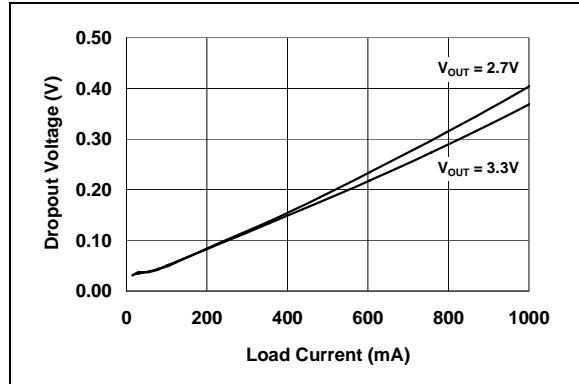

FIGURE 2-4: Dropout Voltage vs. Load Current.

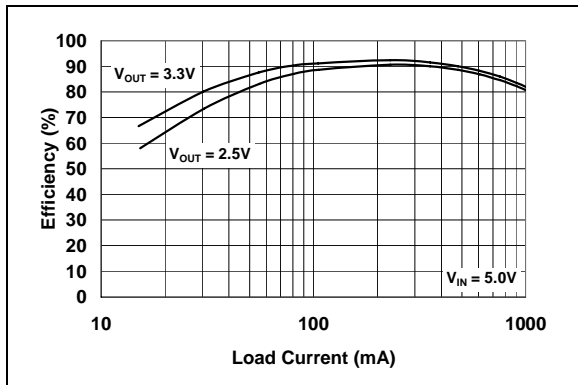

FIGURE 2-2: Efficiency vs. Load Current, $V_{IN} = 5.0V$.

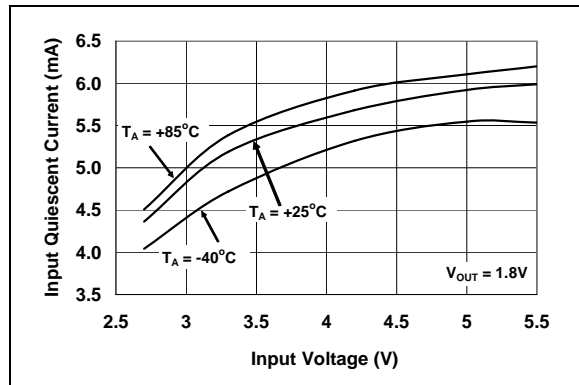

FIGURE 2-5: Input Quiescent Current vs. Input Voltage.

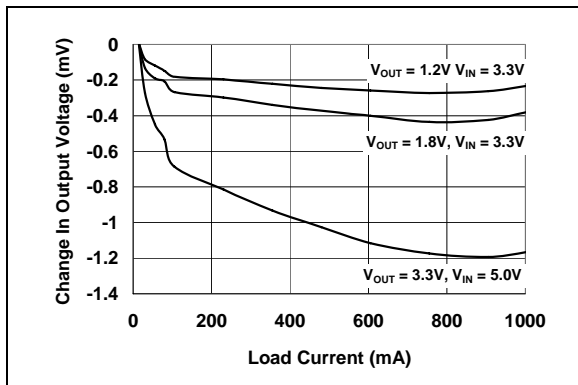

FIGURE 2-3: Output Voltage vs. Load Current.

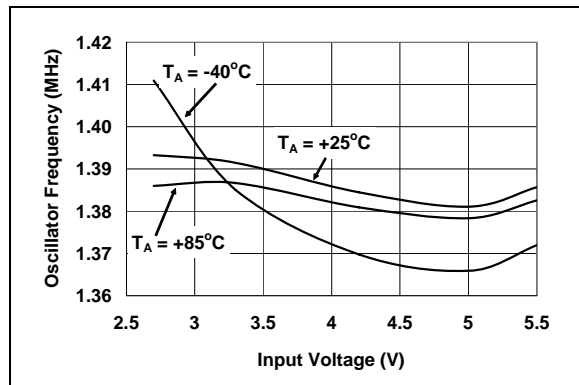

FIGURE 2-6: Oscillator Frequency vs. Input Voltage.

TYPICAL PERFORMANCE CURVES (Continued)

Note: Unless otherwise indicated, $V_{IN} = V_{CC} = V_{\overline{SHDN}} = 3.3V$, $C_{OUT} = C_{IN} = 10 \mu F$, $L = 3.3 \mu H$, $I_{LOAD} = 100 \text{ mA}$, $T_A = +25^\circ C$. **Boldface** specifications apply over the T_A range of $-40^\circ C$ to $+85^\circ C$.

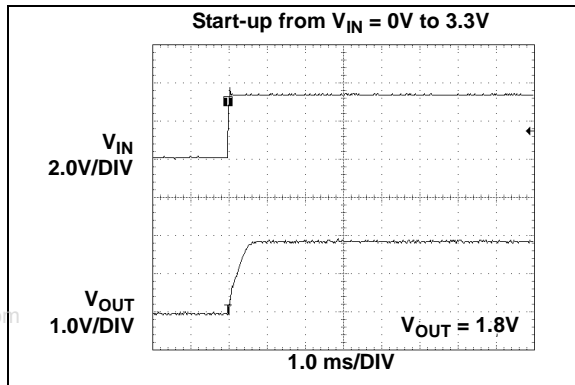

FIGURE 2-7: Power-Up from V_{IN} .

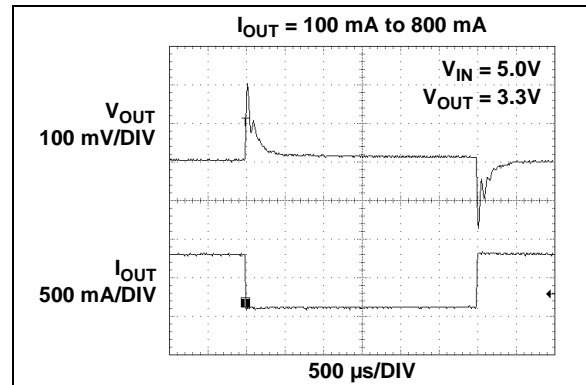

FIGURE 2-10: Load Transient Response.

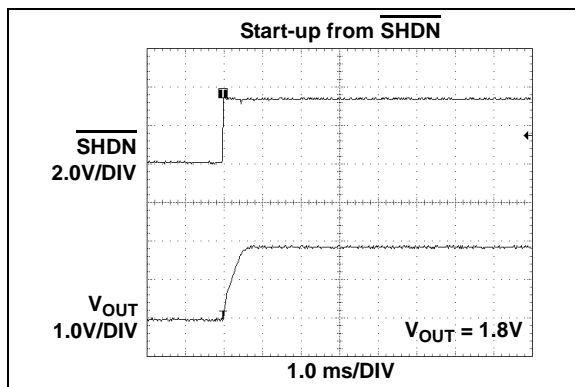

FIGURE 2-8: Power-Up from Shutdown.

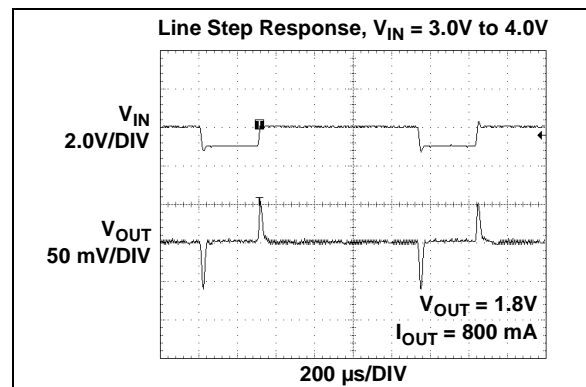

FIGURE 2-11: Line Transient Response.

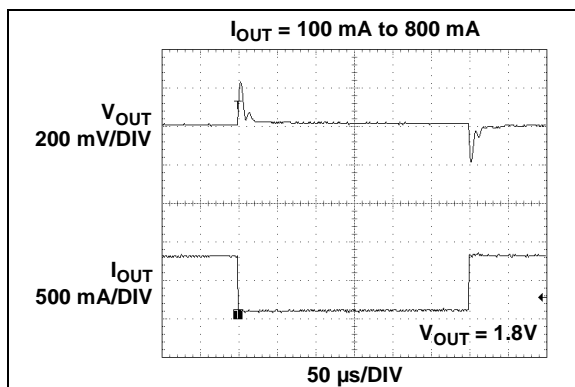

FIGURE 2-9: Load Transient Response.

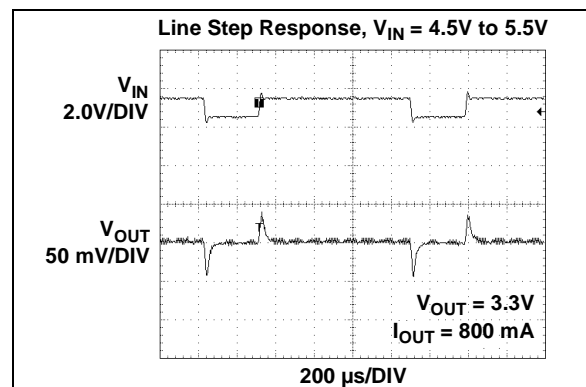

FIGURE 2-12: Line Transient Response.

MCP1612

TYPICAL PERFORMANCE CURVES (Continued)

Note: Unless otherwise indicated, $V_{IN} = V_{CC} = V_{SHDN} = 3.3V$, $C_{OUT} = C_{IN} = 10 \mu F$, $L = 3.3 \mu H$, $I_{LOAD} = 100 \text{ mA}$, $T_A = +25^\circ C$. **Boldface** specifications apply over the T_A range of $-40^\circ C$ to $+85^\circ C$.

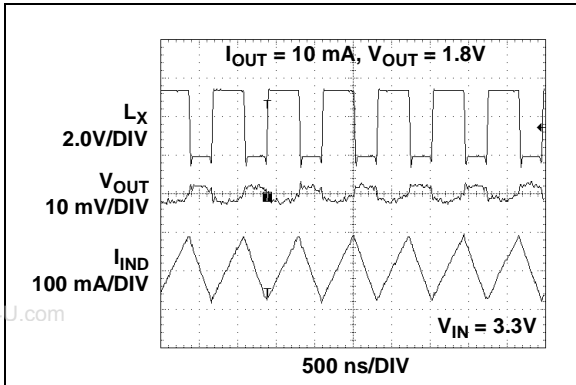

FIGURE 2-13: Low Load Current Switching Waveform.

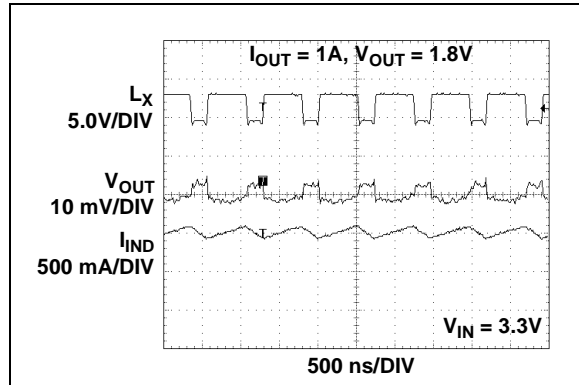

FIGURE 2-14: High Load Current Switching Waveform.

3.0 MCP1612 PIN DESCRIPTIONS

The descriptions of the pins are listed in Table 3-1.

TABLE 3-1: PIN FUNCTION TABLE

Pin No.	Name	Function
1	V_{IN}	Input Voltage Pin
2	V_{CC}	Analog Input Voltage Pin
3	\overline{SHDN}	Shutdown Control Input Pin
4	COMP	Transconductance Amplifier Output Pin
5	FB	Feedback Input Pin
6	A_{GND}	Analog Ground Pin
7	P_{GND}	Power Ground Pin
8	L_X	Buck Inductor Output Pin

3.1 Input Voltage Pin (V_{IN})

Connect the input voltage source to V_{IN} . For normal operation, the voltage on V_{IN} should be between +2.7V and +5.5V. A 10 μ F bypass capacitor should be connected between V_{IN} and P_{GND} .

3.2 Analog Input Voltage Pin (V_{CC})

V_{CC} provides bias for internal analog functions. This voltage is derived by filtering the V_{IN} supply.

3.3 Shutdown Input Pin (\overline{SHDN})

Connect \overline{SHDN} to a logic-level input in order to turn the regulator on or off. A logic-high (>45% of V_{IN}) will enable the regulator. A logic-low (<15% of V_{IN}) will force the regulator into Shutdown mode. When in shutdown, both the P-channel and N-channel switches are turned off.

3.4 Compensation Pin (COMP)

COMP is the internal transconductance amplifier output pin. External compensation is connected to COMP for control-loop stabilization.

3.5 Feedback Pin (FB)

Connect the output voltage of the buck converter through an external resistor divider to FB to regulate the output voltage. The nominal voltage compared to this input for pulse termination is 0.8V.

3.6 Analog Ground Pin (A_{GND})

Tie all small-signal ground returns to A_{GND} . Noise on A_{GND} can effect the sensitive internal analog measurements.

3.7 Power Ground Pin (P_{GND})

Connect all large-signal ground returns to P_{GND} . These large-signal traces should have a small loop area and length to prevent coupling of switching noise to sensitive traces.

3.8 Buck Inductor Output Pin (L_X)

Connect L_X directly to the buck inductor. This pin carries large signal-level currents; all connections should be made as short as possible.

MCP1612

4.0 DETAILED DESCRIPTION

4.1 Device Overview

The MCP1612 is a 1A synchronous buck converter switching at 1.4 MHz to minimize external component size and cost. While utilizing a fixed-frequency Current mode architecture, the MCP1612 provides fast response to sudden load changes, as well as overcurrent protection in the event of a shorted load. The input voltage range is 2.7V to 5.5V, while the output voltage is adjustable by properly setting an external resistor divider and can range from 0.8V to V_{IN} . Integrated soft-start, UVLO and overtemperature protection minimize external circuitry and component count.

4.2 Current Mode Control Scheme

The MCP1612 incorporates a Peak Current mode control scheme. Peak Current mode is used to obtain high gain in the PWM control loop for very fast response to dynamic line and load conditions. With both the P-channel and N-channel MOSFETs turned off, the beginning of a cycle occurs on the negative edge of the internal 1.4 MHz oscillator, the P-channel MOSFET turns on and current ramps up into the buck inductor. The inductor current is sensed and tied to one input of a high-speed comparator. The other input of the high-speed comparator is the error amplifier output. This is the amplified difference between the internal 0.8V reference and the divided-down V_{OUT} signal at the FB pin of the MCP1612. When the sensed inductor current ramps up to the point that is equal to the amplified error signal, the high-speed comparator output switches states and the P-channel MOSFET is turned off until the beginning of the next clock cycle and the N-channel is turned on. The width of the pulse (or duty cycle) is ideally determined by the V_{OUT}/V_{IN} ratio of the DC/DC converter. The actual duty cycle is slightly larger to account for the non-ideal losses of the integrated MOSFET switches and the losses in the external inductor.

4.3 Low-Dropout Operation

The MCP1612 is capable of operating over a wide range of input voltages. The PWM architecture allows for the P-channel MOSFET to achieve 100% duty cycle operation for applications that have minimal input voltage headroom. During 100% Duty Cycle mode, the output voltage (V_{OUT}) is equal to the Output Current (I_{OUT}) x Resistance (P-channel $R_{DS(ON)}$ + $R_{INDUCTOR}$).

4.4 Current Limit

Cycle-by-cycle current limit is used to protect the MCP1612 from being damaged when an external short circuit is applied. The typical peak current limit is 2.3A. If the sensed inductor current reaches the 2.3A limit, the P-channel MOSFET is turned off, even if the output voltage is not in regulation.

4.5 Soft-Start

During normal power-up, as V_{IN} rises above the UVLO protection setting (or, in the case of a logic-low to logic-high transition on the shutdown pin), the rise time of the MCP1612 output voltage is controlled by the soft-start feature. This is accomplished by allowing the output of the error amplifier to slowly rise. This feature prevents the output voltage from overshooting the desired value and the sudden inrush of current, depleting the input capacitors and causing a large dip in input voltage. This large dip in the input voltage can trip the UVLO threshold, causing the converter to shut down prior to reaching steady-state operation.

4.6 Undervoltage Lockout (UVLO)

The UVLO feature uses a comparator to sense the input voltage level (V_{IN}). If the input voltage is lower than the voltage necessary to properly operate the MCP1612, the UVLO feature will hold the converter off. When V_{IN} rises above the necessary input voltage, the UVLO is released and soft-start begins. For the MCP1612, the UVLO protection threshold is at a maximum of 2.7V. Hysteresis is built into the UVLO circuit to compensate for input impedance. For example, if there is any resistance between the input voltage source and the converter (once it starts), there will be a voltage drop at the converter input equal to $I_{IN} \times R_{IN}$. The typical hysteresis for the MCP1612 is 200 mV.

4.7 Overtemperature Protection

The MCP1612 has an integrated overtemperature protection circuit that monitors the device junction temperature and shuts the device off if the junction temperature exceeds the typical 160°C threshold. If the overtemperature threshold is reached, the soft-start is reset so that, when the junction temperature cools to approximately 151°C, the device will automatically restart and the output voltage will not overshoot.

4.8 Shutdown Input Operation

The \overline{SHDN} pin is used to turn the MCP1612 on and off. When the \overline{SHDN} pin is tied low, the MCP1612 is off. When tied high, the MCP1612 will be enabled and begin operation as long as the input voltage is not below the UVLO threshold.

5.0 APPLICATION CIRCUITS/INFORMATION

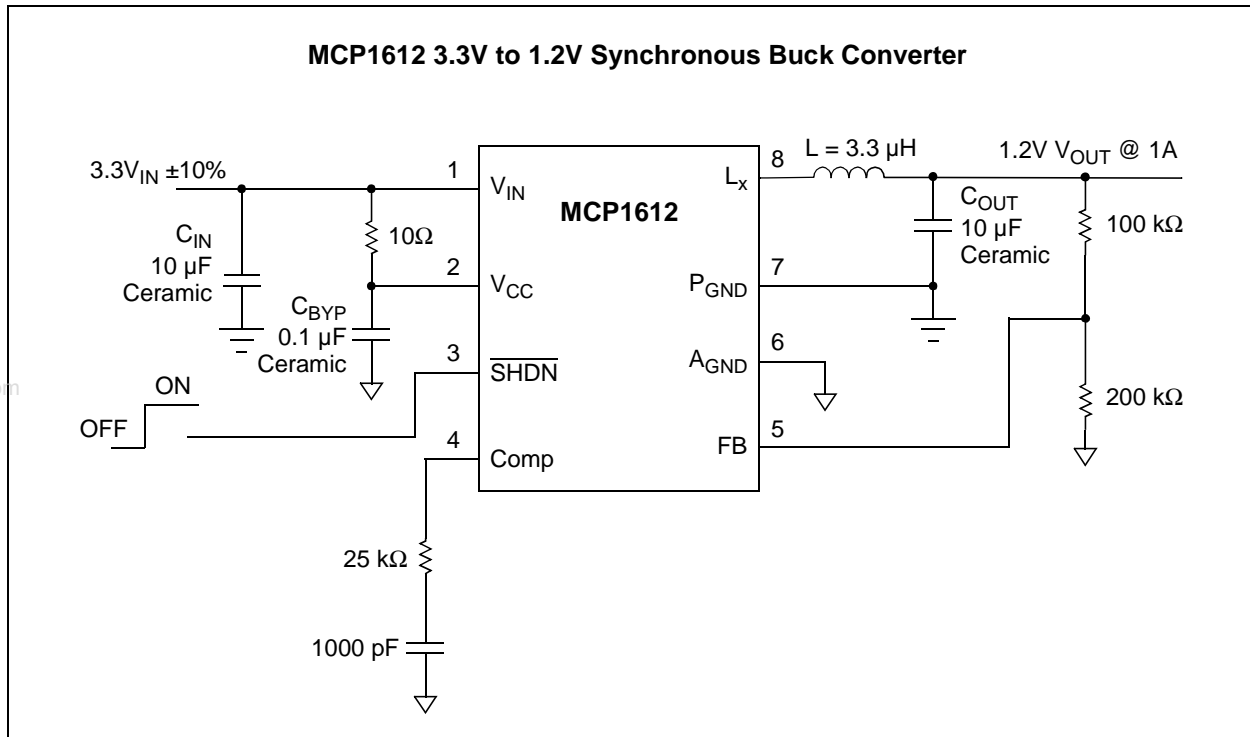

FIGURE 5-1: Typical Application Circuit.

5.1 Typical Applications

The MCP1612 buck controller can be used in several different applications where a voltage that is lower than the supply voltage is required. Its small size, low cost and high efficiency make the MCP1612 a good choice for densely-packaged applications. The input voltage range, low-dropout voltage and low shutdown current make this part perfectly suited for battery-powered applications.

5.2 Design Example

The step-by-step design of a buck converter with the following parameters is presented to illustrate how easy the MCP1612 is to use.

- Input voltage = 3.3V
- Output voltage = 1.2V
- Output current = 0A to 1A
- Switching frequency = 1.4 MHz

5.2.1 SETTING OUTPUT VOLTAGE

The output voltage of the MCP1612 is set by using an external resistor-divider network. The voltage present at FB is internally compared to a 0.8V reference voltage. A 200 kΩ resistor is recommended for R₂, the lower-end of the voltage divider. Using higher-value

resistors will make the circuit more susceptible to noise on the FB pin. Lower-value resistors can be used, if necessary.

Equation 5-1, used to calculate the output voltage, is shown below.

EQUATION 5-1:

$$R_1 = R_2 \times \left(\frac{V_{OUT}}{V_{FB}} - 1 \right)$$

Where:

- V_{OUT} = desired output voltage
- V_{FB} = MCP1612 internal reference voltage
- R₁ = top resistor value
- R₂ = bottom resistor value

For this example:

- V_{OUT} = 1.2V
- V_{FB} = 0.8V
- R₂ = 200 kΩ
- R₁ = 100 kΩ

The MCP1612 is capable of a 15% duty cycle. Instability may result when the duty cycle is below 15%. If less than 15% duty cycle operation is needed, care must be taken to ensure stable operation.

MCP1612

5.2.2 BUCK INDUCTOR

There are many requirements that need to be satisfied when selecting the buck inductor. The application, physical size, current rating, resistance, mounting method, supplier, temperature range, minimum inductance and cost all need to be considered.

Many suppliers specify the maximum peak current that an inductor can handle before magnetic saturation occurs. The peak current is equal to the maximum DC output current, plus one-half the peak-to-peak AC ripple current.

When the P-channel MOSFET is on, the current in the buck inductor is ramped up. The voltage across the inductor, the inductance and the MOSFET on-time are required to determine the peak-to-peak ripple current.

When operating in Continuous Current mode, the on-time of the P-channel MOSFET is determined by multiplying the duty cycle by the switching period. The following equation can be used to determine the duty cycle.

EQUATION 5-2:

$$DutyCycle = \frac{V_{OUT}}{V_{IN}}$$

The on-time is then defined as follows.

EQUATION 5-3:

$$T_{ON} = DutyCycle \times \frac{1}{F_{SW}}$$

Where:
 F_{SW} = switching frequency

The AC ripple current in the inductor can be calculated by the following relationship.

EQUATION 5-4:

$$V_L = L \times \frac{\Delta I_L}{\Delta t}$$

Solving for ΔI_L yields:

EQUATION 5-5:

$$\Delta I_L = \frac{V_L}{L} \times \Delta t$$

Where:
 V_L = voltage across the inductor
($V_{IN} - V_{OUT}$)
 Δt = on-time of the P-channel MOSFET

The value of the buck inductor is chosen to be 3.3 μ H. The AC ripple current is controlled by the size of the buck inductor. The value of the inductor will therefore need to be raised so that the converter operates in Continuous Conduction mode. Calculation of the buck inductor current rating follows.

$$\begin{aligned} V_{IN} &= 3.3V \\ V_{OUT} &= 1.2V \\ F_{SW} &= 1.4 \text{ MHz} \\ I_{OUT(MAX)} &= 1A \\ T_{ON} &= (1.2V/3.3V) \times (1/1.4 \text{ MHz}) \\ T_{ON} &= 260 \text{ ns} \\ V_L &= (3.3V - 1.2V) = 2.1V \\ \Delta I_L &= (2.1V/3.3 \mu\text{H}) \times 260 \text{ ns} \\ \Delta I_L &= 165 \text{ mA} \\ I_{L(PEAK)} &= I_{OUT(MAX)} + 1/2 \Delta I_L \\ I_{L(PEAK)} &= 1A + (165 \text{ mA})/2 \\ I_{L(PEAK)} &= 1.08A \end{aligned}$$

The inductor selected must have an inductance of 3.3 μ H at a peak current rating of 1.08A. The DC resistance of the inductor should be as low as is feasibly possible. Extremely low DC resistance inductors are available, though a trade-off between size and cost should be considered.

5.2.3 OUTPUT CAPACITOR

The output capacitor is used to filter the inductor AC ripple current and provide storage for load transients. The size and Equivalent Series Resistance (ESR) of the output capacitor determines the amount of ripple voltage present at the output of the converter. When selecting the output capacitor, a design trade-off has to be made between the acceptable ripple voltage and the size/cost of the output capacitor. Ceramic capacitors have very low ESR, but increase in cost with higher values. Tantalum and electrolytic capacitors are relatively inexpensive in higher values, but they also have a much higher ESR.

The amount of capacitance needed to obtain the desired ripple voltage is calculated by using the following relationship.

EQUATION 5-6:

$$I_C = C \times \frac{\Delta V_C}{\Delta t}$$

Solving for C:

$$C = I_C \times \frac{\Delta t}{\Delta V_C}$$

Where:

- I_C = peak-to-peak ripple current
- Δt = on-time of P-channel MOSFET
- ΔV_C = output ripple voltage

There will also be some ripple voltage caused by the ESR of the capacitor. The ripple is defined as follows.

EQUATION 5-7:

$$V_{ESRRIPPLE} = ESR \times I_C$$

For this example:

- $I_C = 165 \text{ mA}$
- $C = 4.7 \text{ }\mu\text{F}$
- $\Delta t = 260 \text{ ns}$
- $ESR = 8 \text{ m}\Omega$
- $\Delta V_C = (260 \text{ ns} \times 165 \text{ mA}) / 4.7 \text{ }\mu\text{F}$
- $\Delta V_C = 9.13 \text{ mV}$
- $V_{ESRRIPPLE} = 8 \text{ m}\Omega \times 165 \text{ mA}$
- $V_{ESRRIPPLE} = 1.32 \text{ mV}$
- $\Delta V_{OUT} = \Delta V_C + V_{ESRRIPPLE}$
- $\Delta V_{OUT} = 9.13 \text{ mV} + 1.32 \text{ mV}$
- $\Delta V_{OUT} = 10.45 \text{ mV}$

5.2.4 INPUT CAPACITOR

For the buck topology, the input current is pulled from the source and the input capacitor in pulses. The size of the input capacitor will determine the amount of current pulled from the source. For most applications, a 10 μF ceramic capacitor connected between the MCP1612's V_{IN} and P_{GND} is recommended to filter the current pulses. Less capacitance can be used for applications that have low source impedance. The ripple current rating for ceramic capacitors are typically very high due to their low loss characteristics. Low-cost electrolytic capacitors can be used, but their ripple current rating should not be exceeded.

5.2.5 V_{CC} INPUT

The V_{CC} input is used to bias the internal MCP1612 circuitry. A 10 Ω resistor is recommended between the unregulated inputs V_{IN} and V_{CC} , along with a 0.1 μF capacitor to ground to help isolate the V_{CC} pin from the switching noise.

5.2.6 COMPENSATION COMPONENTS

An internal transconductance error amplifier is used to compensate the buck converter. An external resistor (R_C) and capacitor (C_C), connected between COMP and GND, are all that is needed to provide a high-bandwidth loop.

Table 5-1 identifies values for R_C and C_C for standard buck inductor (L) and output capacitor (C_{OUT}) values.

TABLE 5-1: R_C and C_C VALUES

L	C_{OUT}	R_C	C_C
3.3 μH	10.0 μF	25 k Ω	1000 pF
2.2 μH	4.7 μF	10 k Ω	1000 pF

5.3 Printed Circuit Board (PCB) Layout

The MCP1612 is capable of switching over 1A at 1.4 MHz. As with all high-frequency switching power supplies, good PCB layout techniques are essential to prevent noise generated by the switching power-train from interfering with the sensing circuitry.

There are two ground pins (P_{GND} and A_{GND}) on the MCP1612 to separate the large-signal ground current from the small-signal circuit ground. These two grounds should be kept separate, only connecting near the input bulk capacitor.

Care must also be taken to minimize the length and loop area of the large signal connections. Components connected to this loop consist of the input bulk capacitor, V_{IN} , P_{GND} and L_X pins of the MCP1612, the buck inductor and the output filter capacitor.

MCP1612

6.0 PACKAGING INFORMATION

6.1 Package Marking Information

8-Lead DFN (3mm x 3mm)

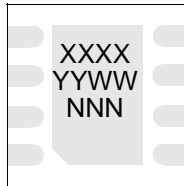

Example:

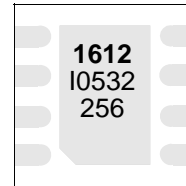

8-Lead MSOP

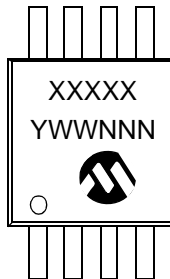

Example:

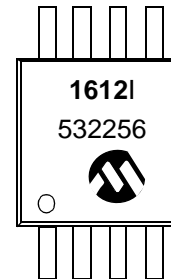

Legend:	XX...X	Customer-specific information
	Y	Year code (last digit of calendar year)
	YY	Year code (last 2 digits of calendar year)
	WW	Week code (week of January 1 is week '01')
	NNN	Alphanumeric traceability code
	(e3)	Pb-free JEDEC designator for Matte Tin (Sn)
	*	This package is Pb-free. The Pb-free JEDEC designator (e3) can be found on the outer packaging for this package.

Note: In the event the full Microchip part number cannot be marked on one line, it will be carried over to the next line, thus limiting the number of available characters for customer-specific information.

8-Lead Plastic Dual-Flat, No-Lead Package (MF) 3x3x0.9 mm Body (DFN) – Saw Singulated

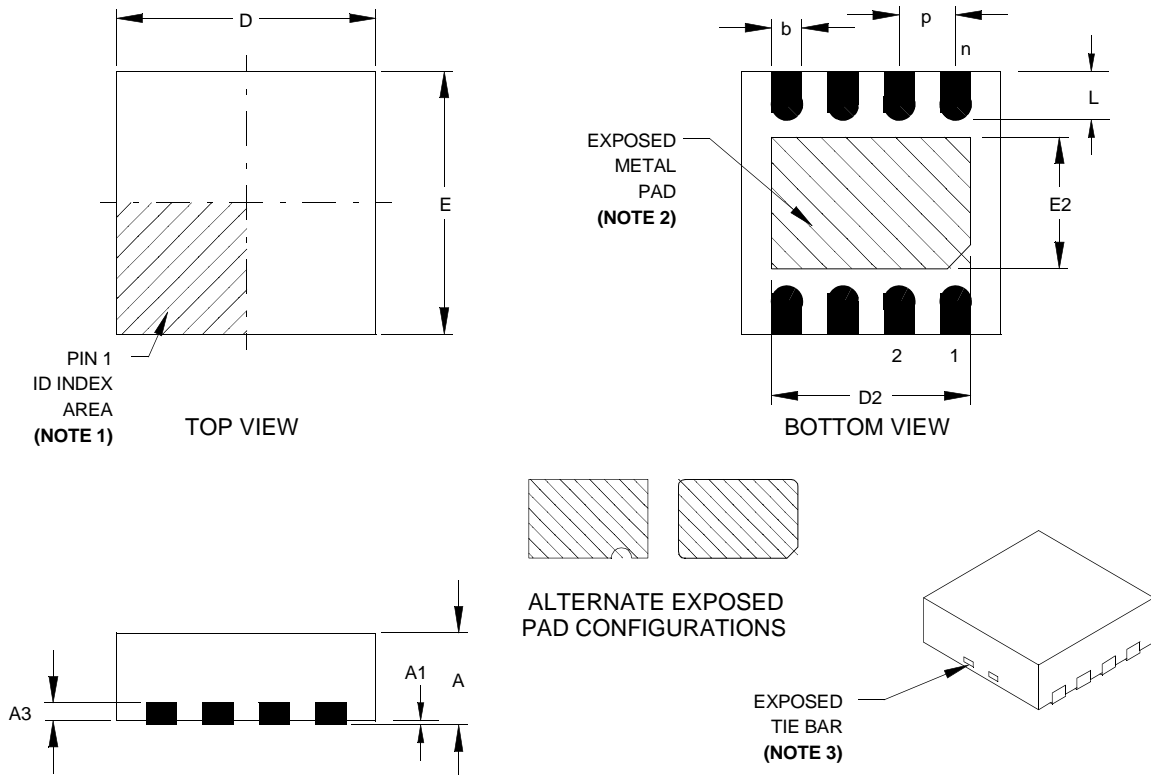

Dimension Limits	Units	INCHES			MILLIMETERS*		
		MIN	NOM	MAX	MIN	NOM	MAX
Number of Pins	n		8			8	
Pitch	p	.026 BSC			0.65 BSC		
Overall Height	A	.031	.035	.039	0.80	0.90	1.00
Standoff	A1	.000	.001	.002	0.00	0.02	0.05
Contact Thickness	A3	.008 REF.			0.20 REF.		
Overall Length	E	.118 BSC			3.00 BSC		
Exposed Pad Width	E2	.043	.061	.063	1.09	1.55	1.60
Overall Width	D	.118 BSC			3.00 BSC		
Exposed Pad Length	D2	.059	.092	.096	1.50	2.37	2.45
Contact Width	b	.009	.012	.015	0.23	0.30	0.37
Contact Length	L	.008	.016	.020	0.20	0.40	0.50

* Controlling Parameter

Notes:

- Pin 1 visual index feature may vary, but must be located within the hatched area.
- Exposed pad varies according to die attach paddle size.
- Package may have one or more exposed tie bars at ends.

BSC: Basic Dimension. Theoretically exact value shown without tolerances.

See ASME Y14.5M

REF: Reference Dimension, usually without tolerance, for information purposes only.

See ASME Y14.5M

JEDEC equivalent: M0-229

Drawing No. C04-062

Revised 07-20-05

MCP1612

8-Lead Plastic Micro Small Outline Package (MS) (MSOP)

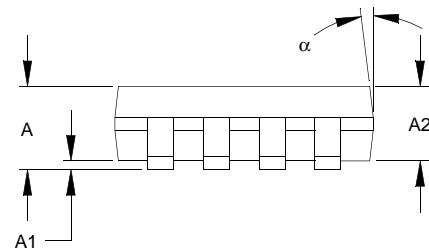
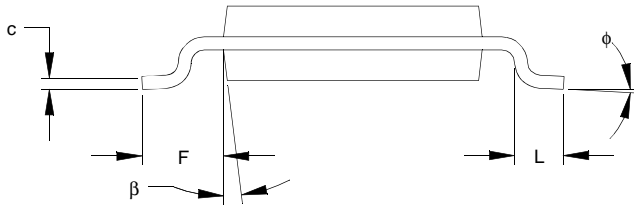
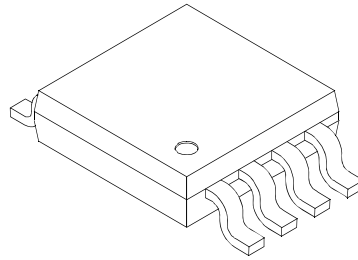
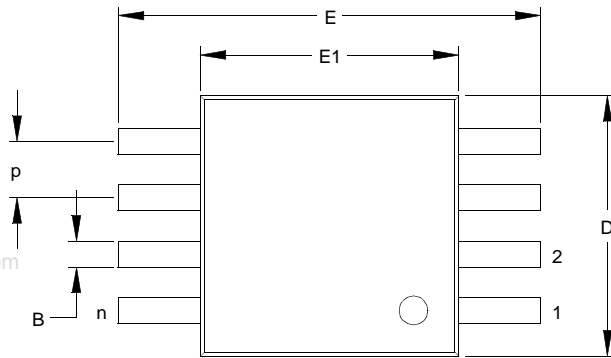

Units		INCHES			MILLIMETERS*		
Dimension Limits		MIN	NOM	MAX	MIN	NOM	MAX
Number of Pins	n		8			8	
Pitch	p	.026 BSC			0.65 BSC		
Overall Height	A	-	-	.043	-	-	1.10
Molded Package Thickness	A2	.030	.033	.037	0.75	0.85	0.95
Standoff	A1	.000	-	.006	0.00	-	0.15
Overall Width	E	.193 BSC			4.90 BSC		
Molded Package Width	E1	.118 BSC			3.00 BSC		
Overall Length	D	.118 BSC			3.00 BSC		
Foot Length	L	.016	.024	.031	0.40	0.60	0.80
Footprint (Reference)	F	.037 REF			0.95 REF		
Foot Angle	ϕ	0°	-	8°	0°	-	8°
Lead Thickness	c	.003	.006	.009	0.08	-	0.23
Lead Width	B	.009	.012	.016	0.22	-	0.40
Mold Draft Angle Top	α	5°	-	15°	5°	-	15°
Mold Draft Angle Bottom	β	5°	-	15°	5°	-	15°

* Controlling Parameter

Notes:

Dimensions D and E1 do not include mold flash or protrusions. Mold flash or protrusions shall not exceed .010" (0.254mm) per side.

BSC: Basic Dimension. Theoretically exact value shown without tolerances.

See ASME Y14.5M

REF: Reference Dimension, usually without tolerance, for information purposes only.

See ASME Y14.5M

JEDEC Equivalent: MO-187

Drawing No. C04-111

Revised 07-21-05

APPENDIX A: REVISION HISTORY

Revision B (September 2005)

The following is the list of modifications:

1. Changed pin 6 in Package Types diagram on front page.
2. Removed device qualification note in Package Marking section.
3. Removed device qualification note in Package Outline drawing.
4. Removed device qualification note in Package Identification System section
5. Replaced MSOP and QFN package diagrams.

Revision A (December 2004)

- Original Release of this Document.

MCP1612

NOTES:

www.DataSheet4U.com

PRODUCT IDENTIFICATION SYSTEM

To order or obtain information, e.g., on pricing or delivery, refer to the factory or the listed sales office.

<u>PART NO.</u>	<u>X</u>	<u>/XX</u>
Device	Temperature Range	Package
Device:	MCP1612:	Synchronous Buck Regulator
	MCP1612T:	Synchronous Buck Regulator (Tape and Reel)
Temperature Range:	I	= -40°C to +85°C
Package:	MF	= Dual Flat, No Lead (3x3mm Body), 8-lead
	MS	= Plastic MSOP, 8-lead

Examples:

- a) MCP1612-ADJI/MS: Industrial Temperature, 8LD MSOP package.
- b) MCP1612T-ADJI/MS: Tape and Reel Industrial Temperature, 8LD MSOP package.
- c) MCP1612-ADJI/MF: Industrial Temperature, 8LD DFN package.
- d) MCP1612T-ADJI/MF: Tape and Reel Industrial Temperature, 8LD DFN package.

MCP1612

NOTES:

www.DataSheet4U.com

Note the following details of the code protection feature on Microchip devices:

- Microchip products meet the specification contained in their particular Microchip Data Sheet.
- Microchip believes that its family of products is one of the most secure families of its kind on the market today, when used in the intended manner and under normal conditions.
- There are dishonest and possibly illegal methods used to breach the code protection feature. All of these methods, to our knowledge, require using the Microchip products in a manner outside the operating specifications contained in Microchip's Data Sheets. Most likely, the person doing so is engaged in theft of intellectual property.
- Microchip is willing to work with the customer who is concerned about the integrity of their code.
- Neither Microchip nor any other semiconductor manufacturer can guarantee the security of their code. Code protection does not mean that we are guaranteeing the product as "unbreakable."

Code protection is constantly evolving. We at Microchip are committed to continuously improving the code protection features of our products. Attempts to break Microchip's code protection feature may be a violation of the Digital Millennium Copyright Act. If such acts allow unauthorized access to your software or other copyrighted work, you may have a right to sue for relief under that Act.

Information contained in this publication regarding device applications and the like is provided only for your convenience and may be superseded by updates. It is your responsibility to ensure that your application meets with your specifications. MICROCHIP MAKES NO REPRESENTATIONS OR WARRANTIES OF ANY KIND WHETHER EXPRESS OR IMPLIED, WRITTEN OR ORAL, STATUTORY OR OTHERWISE, RELATED TO THE INFORMATION, INCLUDING BUT NOT LIMITED TO ITS CONDITION, QUALITY, PERFORMANCE, MERCHANTABILITY OR FITNESS FOR PURPOSE. Microchip disclaims all liability arising from this information and its use. Use of Microchip's products as critical components in life support systems is not authorized except with express written approval by Microchip. No licenses are conveyed, implicitly or otherwise, under any Microchip intellectual property rights.

Trademarks

The Microchip name and logo, the Microchip logo, Accuron, dsPIC, KEELoQ, microID, MPLAB, PIC, PICmicro, PICSTART, PRO MATE, PowerSmart, rPIC, and SmartShunt are registered trademarks of Microchip Technology Incorporated in the U.S.A. and other countries.

AmpLab, FilterLab, Migratable Memory, MXDEV, MXLAB, PICMASTER, SEEVAL, SmartSensor and The Embedded Control Solutions Company are registered trademarks of Microchip Technology Incorporated in the U.S.A.

Analog-for-the-Digital Age, Application Maestro, dsPICDEM, dsPICDEM.net, dsPICworks, ECAN, ECONOMONITOR, FanSense, FlexROM, fuzzyLAB, In-Circuit Serial Programming, ICSP, ICEPIC, Linear Active Thermistor, MPASM, MPLIB, MPLINK, MPSIM, PCKIT, PICDEM, PICDEM.net, PICLAB, PICtail, PowerCal, PowerInfo, PowerMate, PowerTool, rLAB, rPICDEM, Select Mode, Smart Serial, SmartTel, Total Endurance and WiperLock are trademarks of Microchip Technology Incorporated in the U.S.A. and other countries.

SQTP is a service mark of Microchip Technology Incorporated in the U.S.A.

All other trademarks mentioned herein are property of their respective companies.

© 2005, Microchip Technology Incorporated, Printed in the U.S.A., All Rights Reserved.

 Printed on recycled paper.

QUALITY MANAGEMENT SYSTEM
CERTIFIED BY DNV
== ISO/TS 16949:2002 ==

Microchip received ISO/TS-16949:2002 quality system certification for its worldwide headquarters, design and wafer fabrication facilities in Chandler and Tempe, Arizona and Mountain View, California in October 2003. The Company's quality system processes and procedures are for its PICmicro® 8-bit MCUs, KEELoQ® code hopping devices, Serial EEPROMs, microperipherals, nonvolatile memory and analog products. In addition, Microchip's quality system for the design and manufacture of development systems is ISO 9001:2000 certified.



WORLDWIDE SALES AND SERVICE

AMERICAS

Corporate Office

2355 West Chandler Blvd.

Chandler, AZ 85224-6199

Tel: 480-792-7200

Fax: 480-792-7277

Technical Support:

<http://support.microchip.com>

Web Address:

www.microchip.com

Atlanta

Alpharetta, GA

Tel: 770-640-0034

Fax: 770-640-0307

Boston

Westborough, MA

Tel: 774-760-0087

Fax: 774-760-0088

Chicago

Itasca, IL

Tel: 630-285-0071

Fax: 630-285-0075

Dallas

Addison, TX

Tel: 972-818-7423

Fax: 972-818-2924

Detroit

Farmington Hills, MI

Tel: 248-538-2250

Fax: 248-538-2260

Kokomo

Kokomo, IN

Tel: 765-864-8360

Fax: 765-864-8387

Los Angeles

Mission Viejo, CA

Tel: 949-462-9523

Fax: 949-462-9608

San Jose

Mountain View, CA

Tel: 650-215-1444

Fax: 650-961-0286

Toronto

Mississauga, Ontario,

Canada

Tel: 905-673-0699

Fax: 905-673-6509

ASIA/PACIFIC

Australia - Sydney

Tel: 61-2-9868-6733

Fax: 61-2-9868-6755

China - Beijing

Tel: 86-10-8528-2100

Fax: 86-10-8528-2104

China - Chengdu

Tel: 86-28-8676-6200

Fax: 86-28-8676-6599

China - Fuzhou

Tel: 86-591-8750-3506

Fax: 86-591-8750-3521

China - Hong Kong SAR

Tel: 852-2401-1200

Fax: 852-2401-3431

China - Qingdao

Tel: 86-532-8502-7355

Fax: 86-532-8502-7205

China - Shanghai

Tel: 86-21-5407-5533

Fax: 86-21-5407-5066

China - Shenyang

Tel: 86-24-2334-2829

Fax: 86-24-2334-2393

China - Shenzhen

Tel: 86-755-8203-2660

Fax: 86-755-8203-1760

China - Shunde

Tel: 86-757-2839-5507

Fax: 86-757-2839-5571

China - Wuhan

Tel: 86-27-5980-5300

Fax: 86-27-5980-5118

China - Xian

Tel: 86-29-8833-7250

Fax: 86-29-8833-7256

ASIA/PACIFIC

India - Bangalore

Tel: 91-80-2229-0061

Fax: 91-80-2229-0062

India - New Delhi

Tel: 91-11-5160-8631

Fax: 91-11-5160-8632

India - Pune

Tel: 91-20-2566-1512

Fax: 91-20-2566-1513

Japan - Yokohama

Tel: 81-45-471-6166

Fax: 81-45-471-6122

Korea - Gumi

Tel: 82-54-473-4301

Fax: 82-54-473-4302

Korea - Seoul

Tel: 82-2-554-7200

Fax: 82-2-558-5932 or

82-2-558-5934

Malaysia - Penang

Tel: 604-646-8870

Fax: 604-646-5086

Philippines - Manila

Tel: 632-634-9065

Fax: 632-634-9069

Singapore

Tel: 65-6334-8870

Fax: 65-6334-8850

Taiwan - Hsin Chu

Tel: 886-3-572-9526

Fax: 886-3-572-6459

Taiwan - Kaohsiung

Tel: 886-7-536-4818

Fax: 886-7-536-4803

Taiwan - Taipei

Tel: 886-2-2500-6610

Fax: 886-2-2508-0102

Thailand - Bangkok

Tel: 66-2-694-1351

Fax: 66-2-694-1350

EUROPE

Austria - Weis

Tel: 43-7242-2244-399

Fax: 43-7242-2244-393

Denmark - Copenhagen

Tel: 45-4450-2828

Fax: 45-4485-2829

France - Paris

Tel: 33-1-69-53-63-20

Fax: 33-1-69-30-90-79

Germany - Munich

Tel: 49-89-627-144-0

Fax: 49-89-627-144-44

Italy - Milan

Tel: 39-0331-742611

Fax: 39-0331-466781

Netherlands - Drunen

Tel: 31-416-690399

Fax: 31-416-690340

Spain - Madrid

Tel: 34-91-352-30-52

Fax: 34-91-352-11-47

UK - Wokingham

Tel: 44-118-921-5869

Fax: 44-118-921-5820

08/24/05