

SHINDENGEN

Schottky Rectifiers (SBD)

Dual

SF10SC3L

30V 10A

FEATURES

- Tj150°C
- Low $V_F=0.45V$
- P_{RRSM} avalanche guaranteed
- Fully Isolated Molding
- Dielectric strength 2kV guaranteed

APPLICATION

- Switching power supply
- DC/DC converter
- Home Appliances, Office Equipment
- Telecommunication

OUTLINE DIMENSIONS

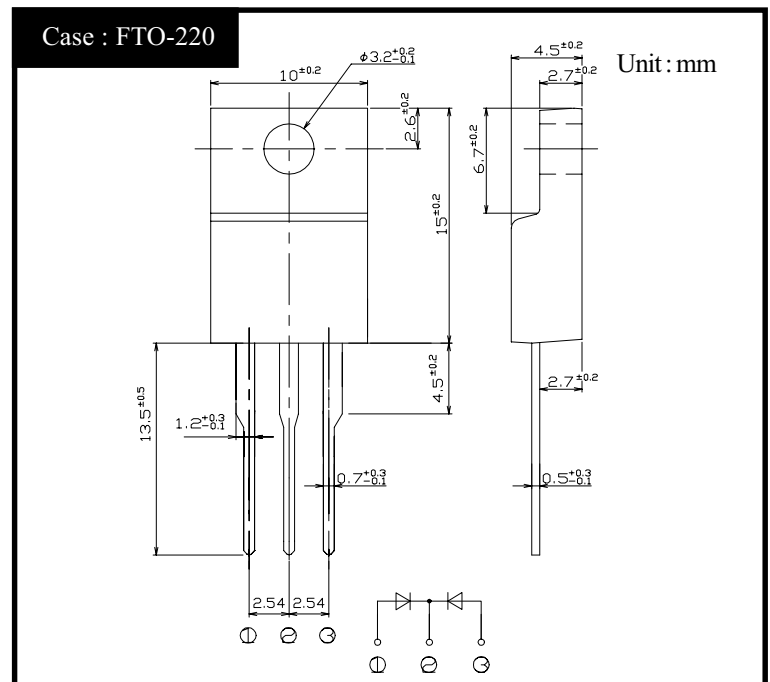

RATINGS

● Absolute Maximum Ratings (If not specified $T_c=25^\circ C$)

Item	Symbol	Conditions	Ratings	Unit
Storage Temperature	Tstg		-55~150	°C
Operating Junction Temperature	Tj		150	°C
Maximum Reverse Voltage	V_{RM}		30	V
Repetitive Peak Surge Reverse Voltage	V_{RRSM}	Pulse width 0.5ms, duty 1/40	35	V
Average Rectified Forward Current	I_O	50Hz sine wave, R-load, Rating for each diode $I_o/2$, $T_c=139^\circ C$	10	A
Peak Surge Forward Current	I_{FSM}	50Hz sine wave, Non-repetitive 1 cycle peak value, $T_j=25^\circ C$	150	A
Repetitive Peak Surge Reverse Power	P_{RRSM}	Pulse width 10 μ s, Rating of per diode, $T_j=25^\circ C$	330	W
Dielectric Strength	V_{dis}	Terminals to case, AC 1 minute	2	kV
Mounting Torque	TOR	(Recommended torque:0.3N·m)	0.5	N·m

● Electrical Characteristics (If not specified $T_c=25^\circ C$)

Item	Symbol	Conditions	Ratings	Unit
Forward Voltage	V_F	$I_F=4A$, Pulse measurement, Rating of per diode	Max.0.45	V
Reverse Current	I_R	$V_R=V_{RM}$, Pulse measurement, Rating of per diode	Max.5	mA
Junction Capacitance	C_j	$f=1MHz$, $V_R=10V$, Rating of per diode	Typ.310	pF
Thermal Resistance	θ_{jc}	junction to case	Max.2.3	°C/W

SF10SC3L Forward Voltage

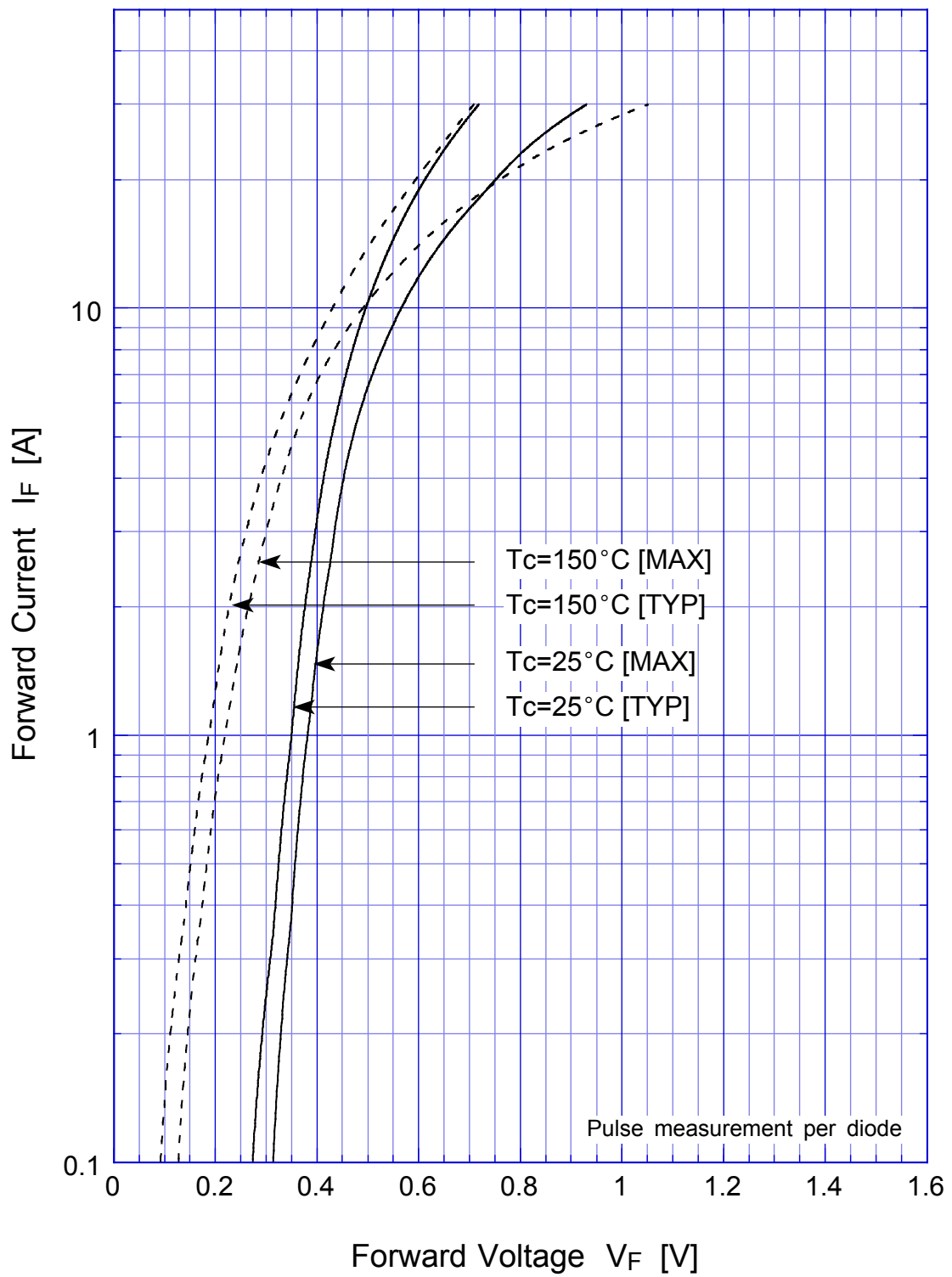

SF10SC3L Junction Capacitance

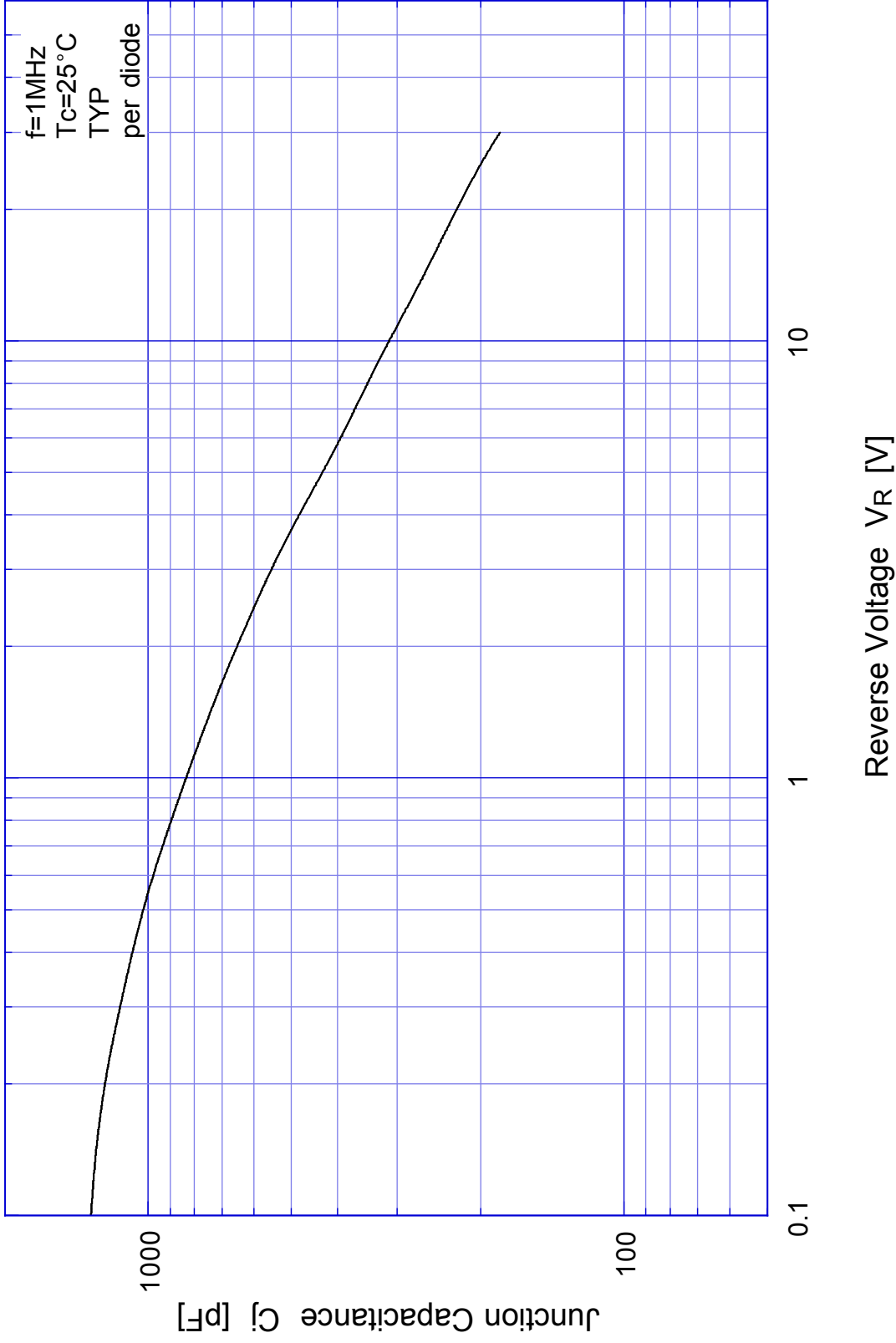

SF10SC3L Reverse Current

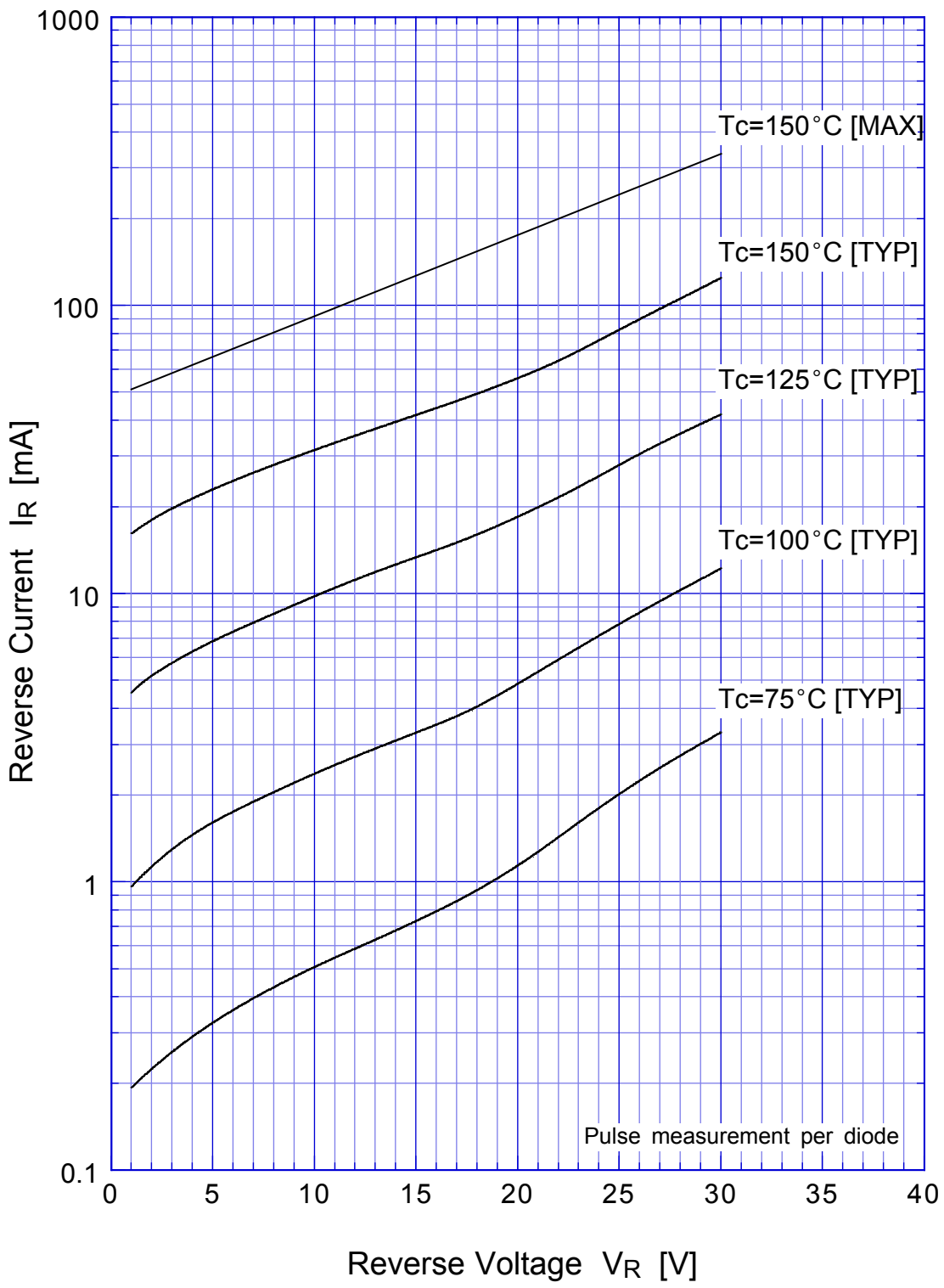

SF10SC3L Reverse Power Dissipation

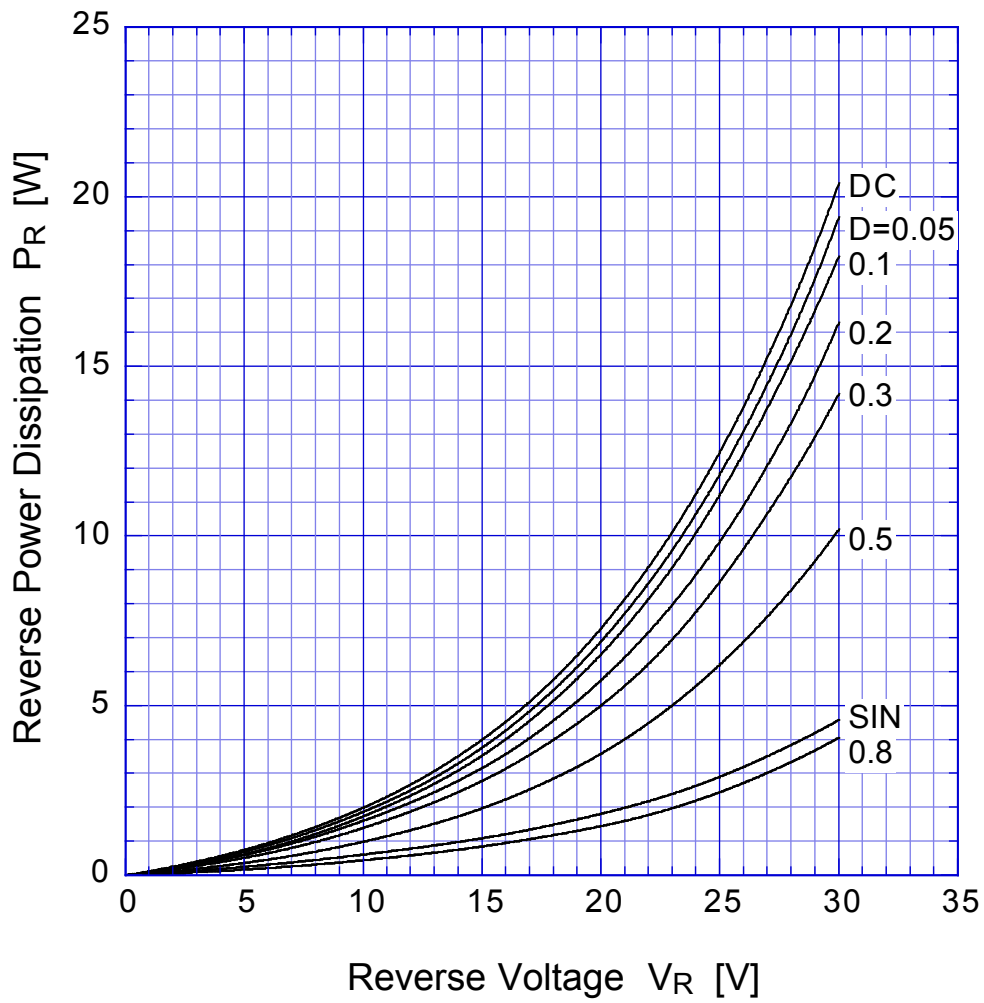

$T_j = 150^\circ\text{C}$

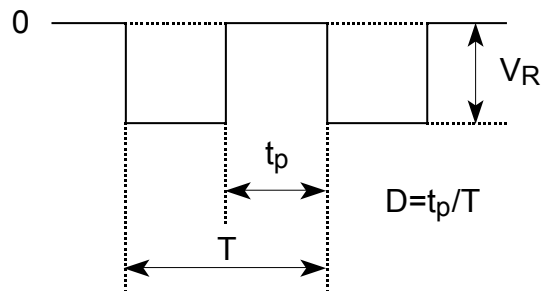

SF10SC3L Forward Power Dissipation

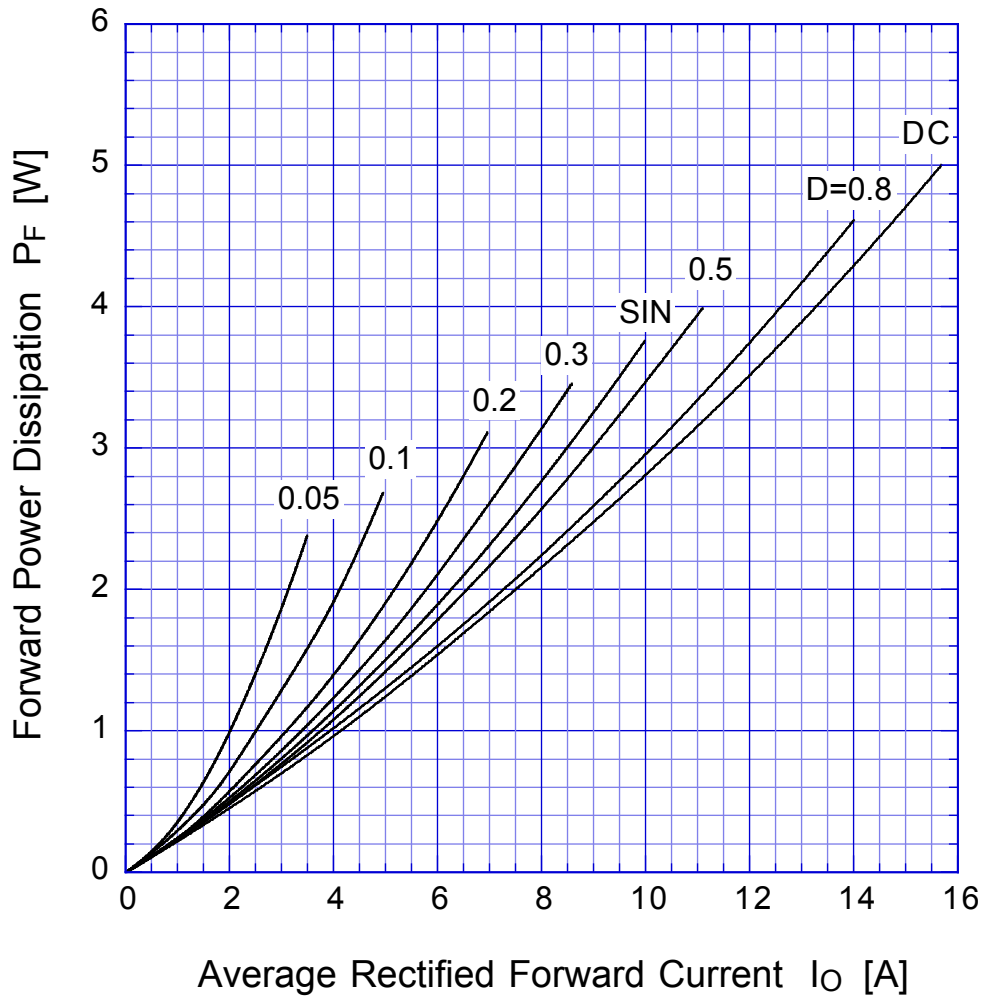

$T_j = 150^\circ\text{C}$

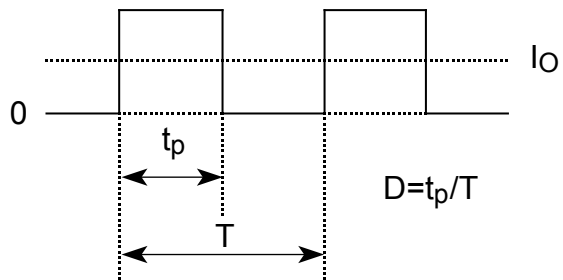

SF10SC3L

Derating Curve

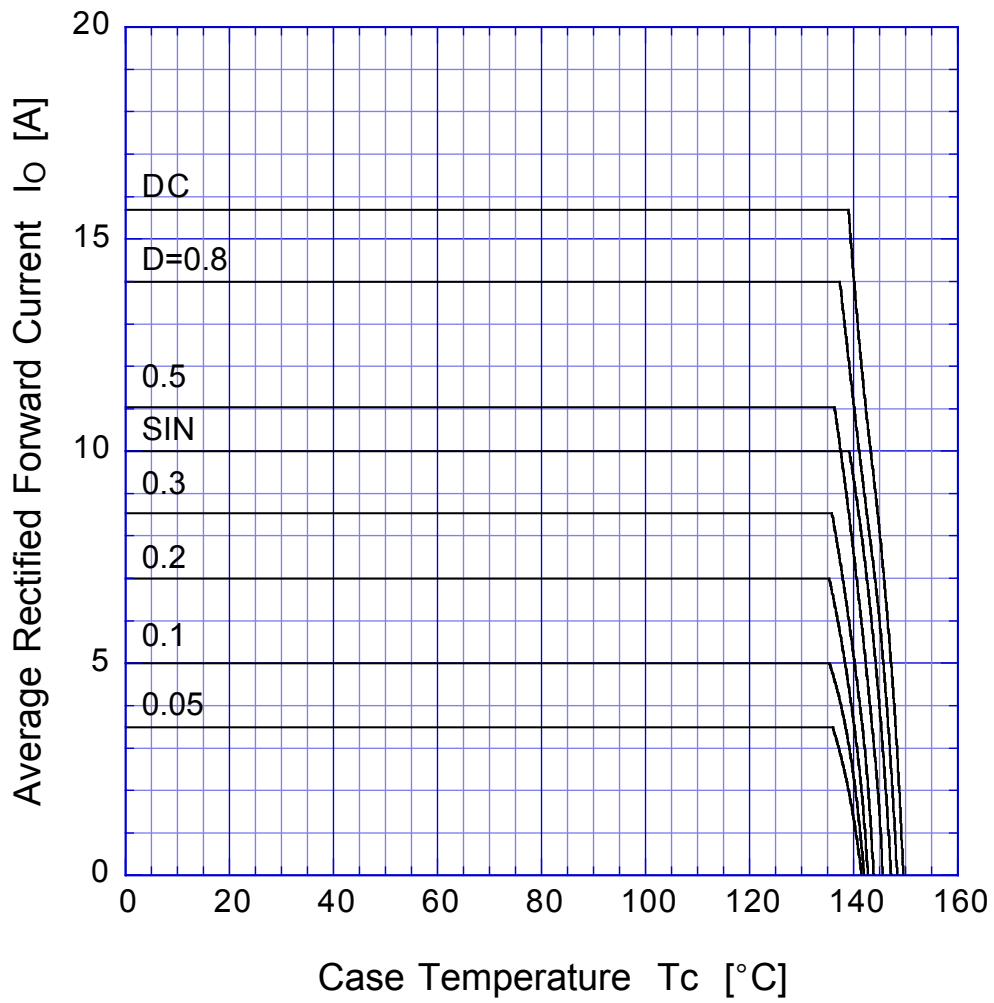

$V_R = 30V$



SF10SC3L Peak Surge Forward Capability

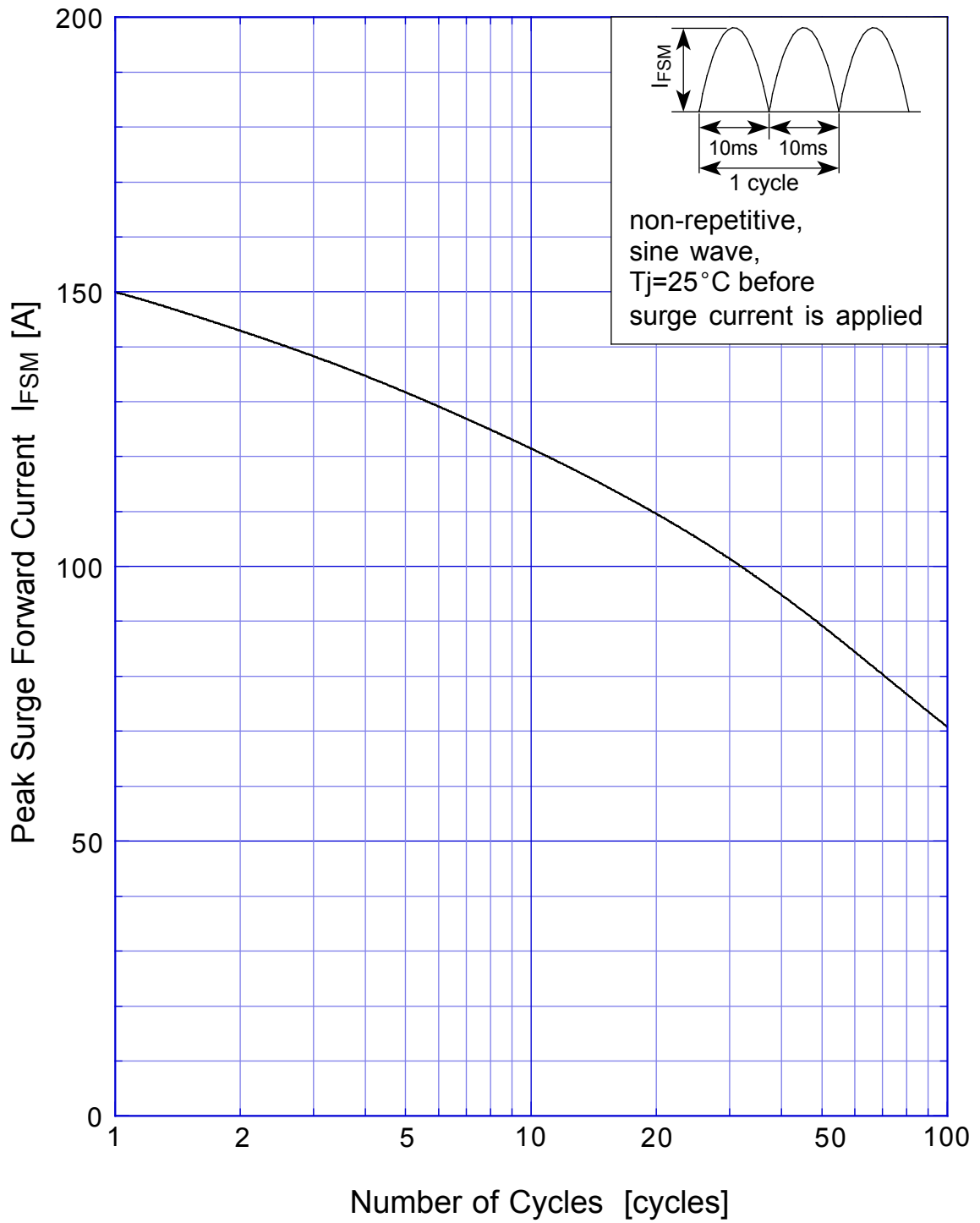

SBD Repetitive Surge Reverse Power Derating Curve



SBD

Repetitive Surge Reverse Power Capability

