

FAN7005

200mW Stereo Power Amplifier with Shutdown

Features

- 200mW and 300mW Power Per Each Channel into 8Ω Load with Less Than 0.3% and 10% THD+N, Respectively
- Low Shutdown Current : 0.1μA(Typ.)
- No Bootstrap Capacitors or Snubber Circuits are Necessary
- Stable Unity-Gain
- Guaranteed Stability Under No Load Condition
- External Gain Configuration Capability
- Thermal Shutdown Protection Circuitry
- Pop Reduction Circuit
- 8MSOP Surface Mount Packaging

Typical Applications

- PDA
- MP3/CDP
- Portable Audio System

Description

The FAN7005 is a dual, fully differential audio power amplifier delivering 200mW(typ.) of continuous power into an 8Ω load. When driving 200mW into an 8Ω load from a 5V power supply, the FAN7005 has less than 0.3% of THD+N over the entire audible frequency range. To reduce the power consumption in portable applications, the FAN7005 provides a shutdown capability. In shutdown condition, current consumption is reduced to less than 2μA. The FAN7005 is designed specifically to provide high quality output power with a minimal amount of external components using surface mount packaging. Since the additional snubber circuits or bootstrap capacitors are not needed, the FAN7005 is well suited for portable systems and other hand-held devices.

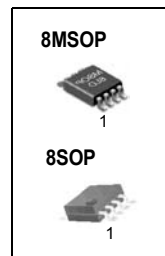

Internal Block Diagram

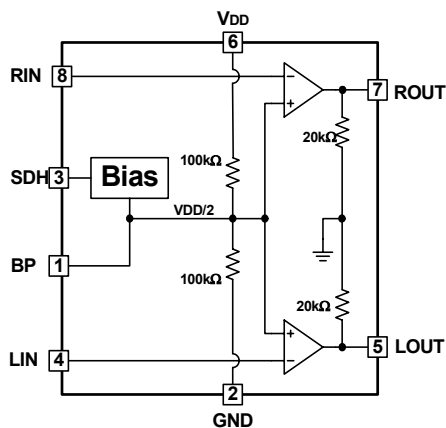

FAN7005MU(8MSOP)

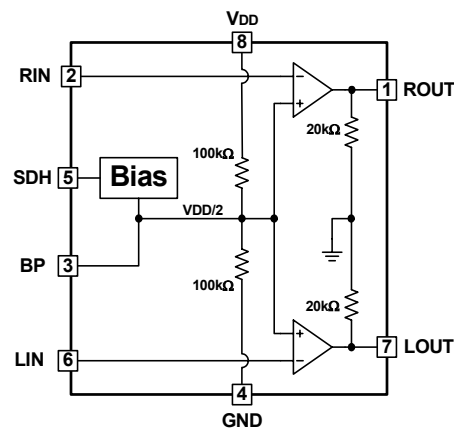

FAN7005M(8SOP)

Pin Assignments

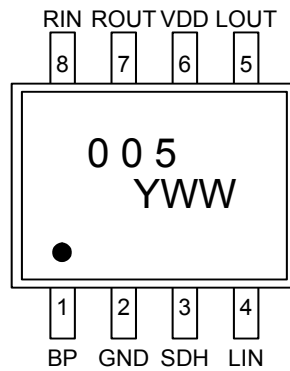

FAN7005MU(8MSOP)

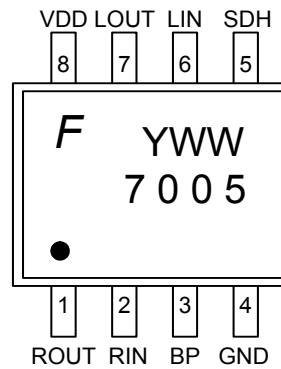

FAN7005M(8SOP)

Y ; Yearly Code
WW ; Weekly Code

Pin Definitions

() : 8SOP

Pin Number	Pin Name	Pin Function Description
1(3)	BP	Tap to Voltage Divider for Internal a Half Supply Bias
2(4)	GND	Ground Connection for Circuitry
3(5)	SDH	Shutdown all Amplifier, Hold High to Shutdown, Hold Low for Normal Operation
4(6)	LIN	Signal Input Left-Channel
5(7)	LOUT	Output Left-Channel
6(8)	VDD	Supply Voltage Input
7(1)	ROUT	Output Right-Channel
8(2)	RIN	Signal Input Right-Channel

Absolute Maximum Ratings (Note2)

Parameter	Symbol	Value	Unit	Remark
Maximum Supply Voltage	VDD	6.0	V	-
Storage Temperature	TSTG	-65 ~ +150	°C	-
Power Dissipation (Note3)	PD	Internally Limited	W	-
Thermal Resistance (Note3)	Rthja	210	°C/W	8MSOP, Junction to Ambient

Operating Ratings

Parameter	Symbol	Min.	Typ.	Max.	Unit
Operating Supply Voltage	VDD	2.7	-	5.5	V
Operating Temperature	TOPR	-40	-	+85	°C

Electrical Characteristics (Notes1,2)

(Ta = 25°C, unless otherwise specified)

Parameter	Symbol	Conditions	Min.	Typ.	Max.	Unit	
V_{DD} = 5.0V, UNLESS OTHERWISE SPECIFIED							
Quiescent Power Supply Current	I _{DD}	No Input, No Load	-	2.2	5.0	mA	
Shutdown Current	I _{SD}	V _{SD} =V _{DD}	-	0.1	2.0	μA	
Output Offset Voltage	V _{OFF}	V _{IN} =0V	-25	0	25	mV	
Output Power	P _O	THD=0.3% (Max.), f=1kHz	R _L =8Ω	125	200	-	mW
			R _L =32Ω	-	85	-	mW
		THD=10% (Max.), f=1kHz	R _L =8Ω	-	300	-	mW
			R _L =32Ω	-	110	-	mW
Total Harmonic Distortion+Noise	THD+N	R _L =8Ω, P _o =125mWrms, f=1kHz	-	0.04	-	%	
		R _L =32Ω, P _o =75mWrms, f=1kHz	-	0.015	-	%	
Power Supply Rejection Ratio	PSRR	C _B =1μF, V _{RIPPLE} =250mVrms, f=1kHz	-	50	-	dB	
V_{DD} = 3.0V, UNLESS OTHERWISE SPECIFIED							
Quiescent Power Supply Current	I _{DD}	No Input, No Load	-	1.8	-	mA	
Shutdown Current	I _{SD}	V _{SD} =V _{DD}	-	-	2.0	μA	
Output Offset Voltage	V _{OFF}	V _{IN} =0V	-25	0	25	mV	
Output Power	P _O	THD=0.3% (Max.), f=1kHz	R _L =8Ω	-	70	-	mW
			R _L =32Ω	-	30	-	mW
		THD=10% (Max.), f=1kHz,	R _L =8Ω	-	95	-	mW
			R _L =32Ω	-	35	-	mW
Total Harmonic Distortion+Noise	THD+N	R _L =8Ω, P _o =70mWrms, f=1kHz	-	0.05	-	%	
		R _L =32Ω, P _o =25mWrms, f=1kHz	-	0.02	-	%	
Power Supply Rejection Ratio	PSRR	C _B =1μF, V _{RIPPLE} =200mVrms, f=1kHz	-	50	-	dB	

Note:

- All voltages are measured with respect to the ground pin, unless otherwise specified.
- Absolute Maximum Ratings indicate limits beyond which damage to the device may occur. Operating Ratings indicate conditions for which the device is functional, but do not guarantee specific performance limits. Electrical Characteristics state DC and AC electrical specifications under particular test conditions which guarantee specific performance limits. This assumes that the device is within the Operating Ratings. Specifications are not guaranteed for parameters where no limit is given, however, the typical value is a good indication of device performance.
- The maximum power dissipation must be derated at elevated temperatures and is dictated by T_{JMAX}, R_{thja} and the ambient temperature T_A. The maximum allowable power dissipation is P_{DMAX} = (T_{JMAX} - T_A)/R_{thja}. For the FAN7005, T_{JMAX} = 150°C, and the typical junction-to-ambient thermal resistance, when board mounted, is 210°C/W for the 8MSOP Package.

Performance Characteristics

Table of Graphs

		Figure
THD+N, Total Harmonic Distortion plus Noise	Output Power	1,2,3,4,5,6
Power Dissipation		24,25
THD+N, Total Harmonic Distortion plus Noise	Frequency	7,8,9,10,11,12
PSRR, Power Supply Rejection Ratio		13, 14
Cross Talk		15
Output Level		16,17,18,19,20
Noise Floor		21
Supply Current	Supply Voltage	22
Output Power		26,27
Dropout Voltage		30
Supply Current	Shutdown Voltage	23
Output Power	Load Resistance	28,29
Power Dissipation	Ambient Temperature	31

Typical Performance Characteristics

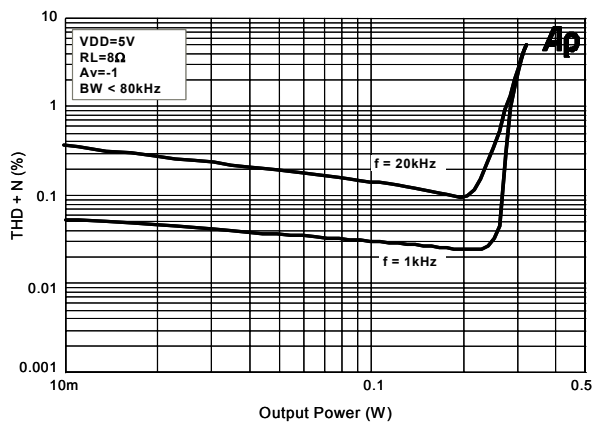

Figure 1. THD+N vs. Output Power

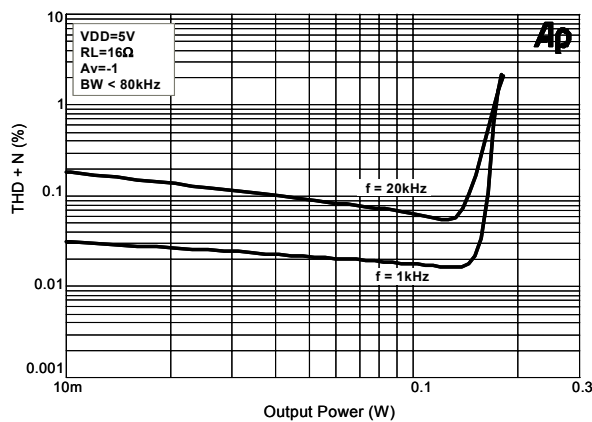

Figure 2. THD+N vs. Output Power

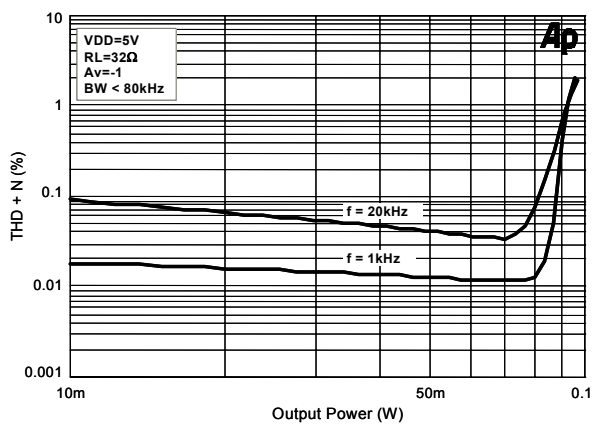

Figure 3. THD+N vs. Output Power

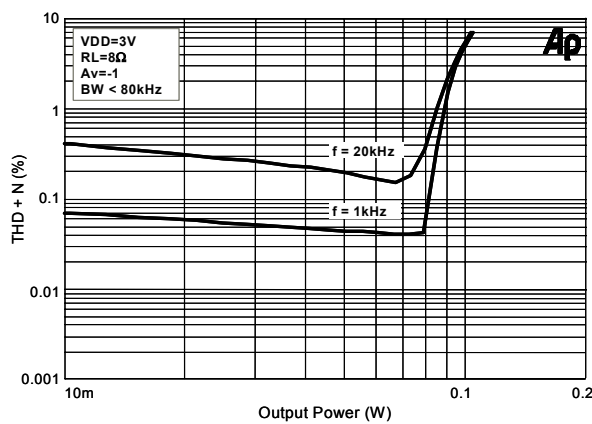

Figure 4. THD+N vs. Output Power

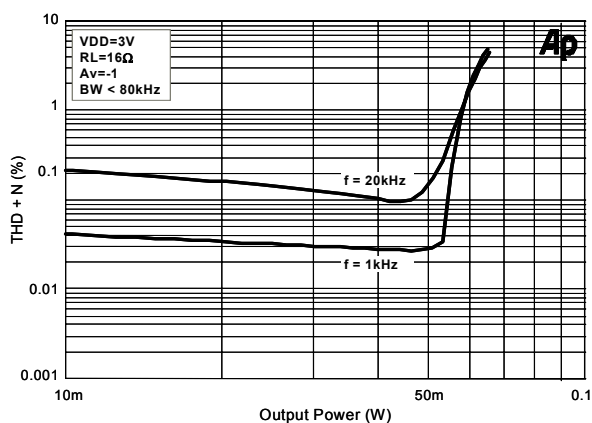

Figure 5. THD+N vs. Output Power

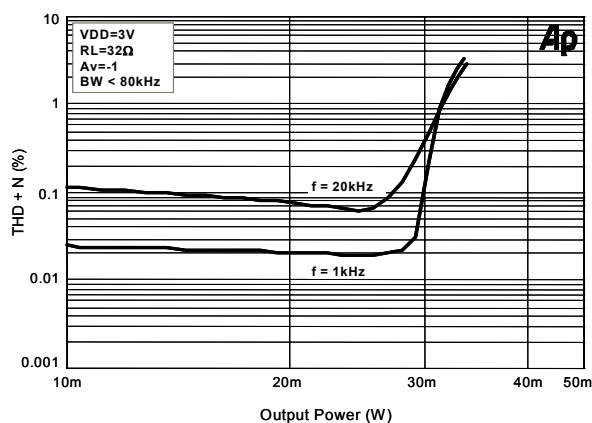

Figure 6. THD+N vs. Output Power

Typical Performance Characteristics (Continued)

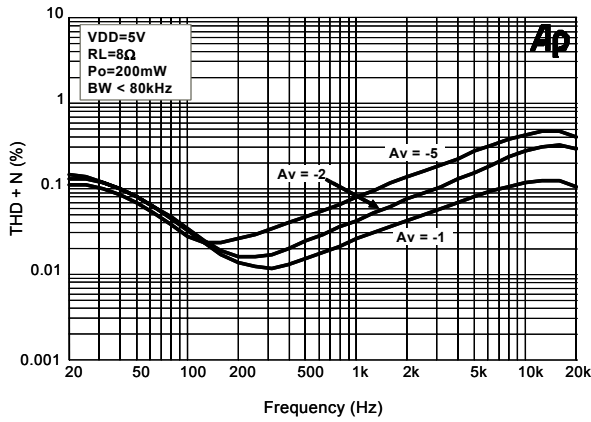

Figure 7. THD+N vs. Frequency

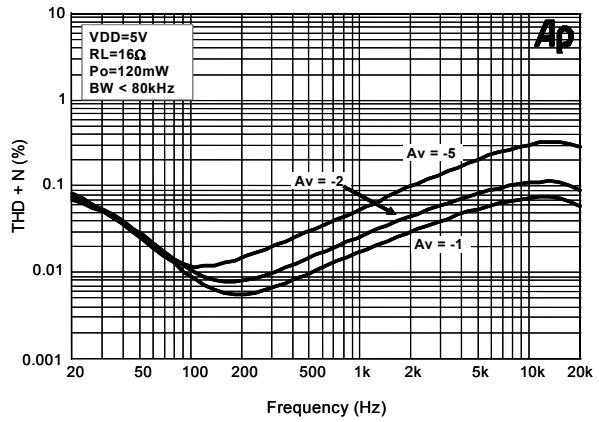

Figure 8. THD+N vs. Frequency

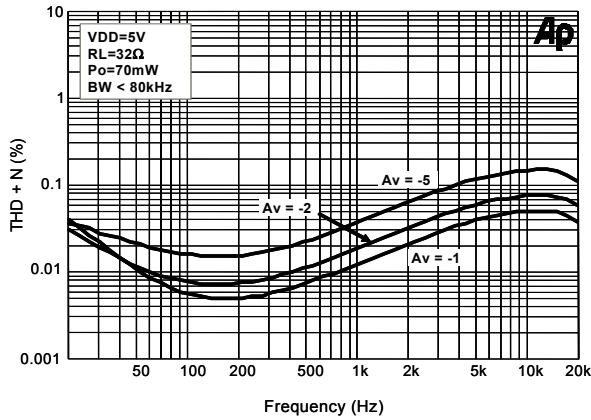

Figure 9. THD+N vs. Frequency

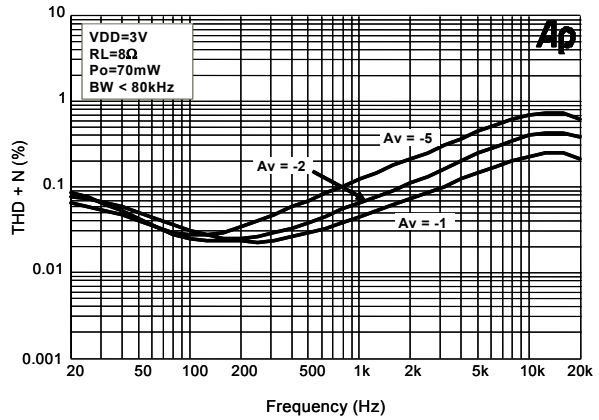

Figure 10. THD+N vs. Frequency

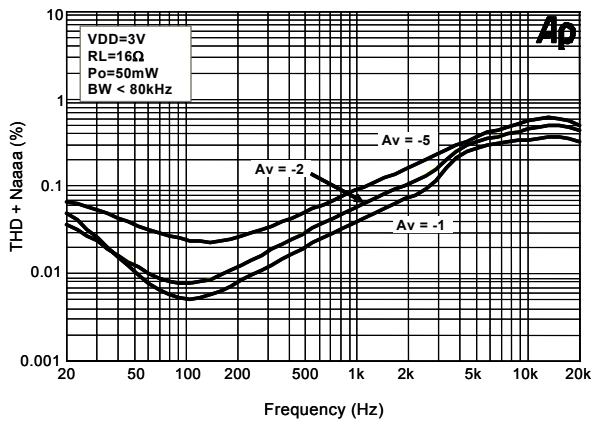

Figure 11. THD+N vs. Frequency

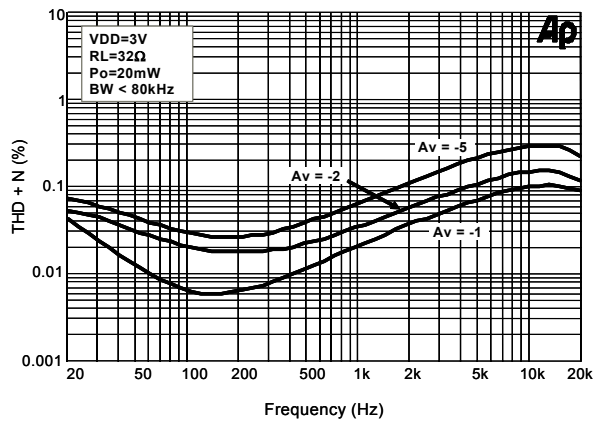

Figure 12. THD+N vs. Frequency

Typical Performance Characteristics (Continued)

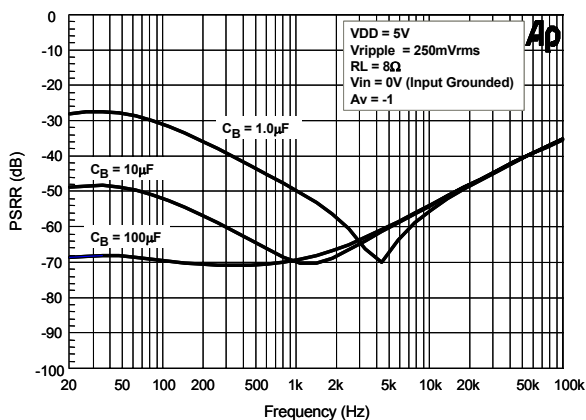

Figure 13. Power Supply Rejection Ratio

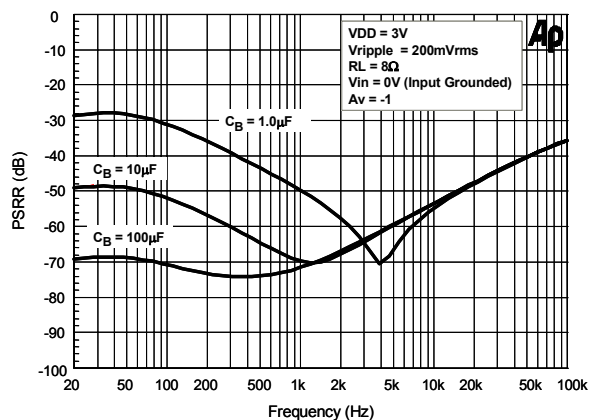

Figure 14. Power Supply Rejection Ratio

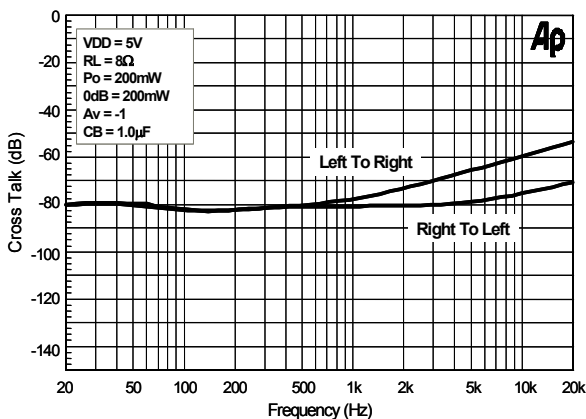

Figure 15. Cross Talk vs. Frequency

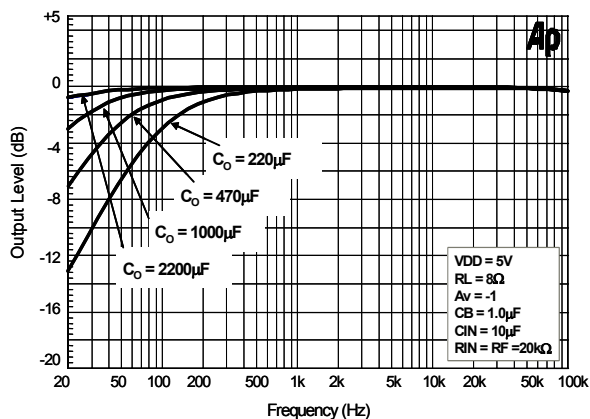

Figure 16. Output Level vs. Frequency

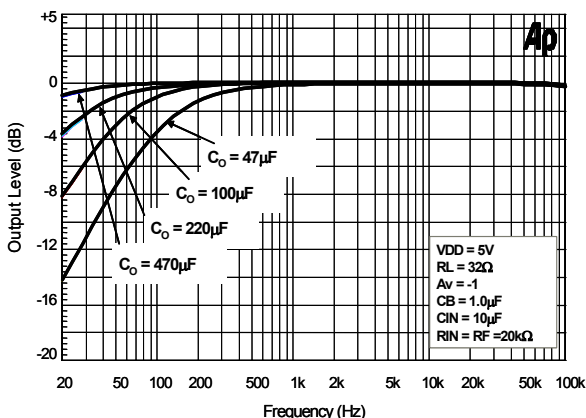

Figure 17. Output Level vs. Frequency

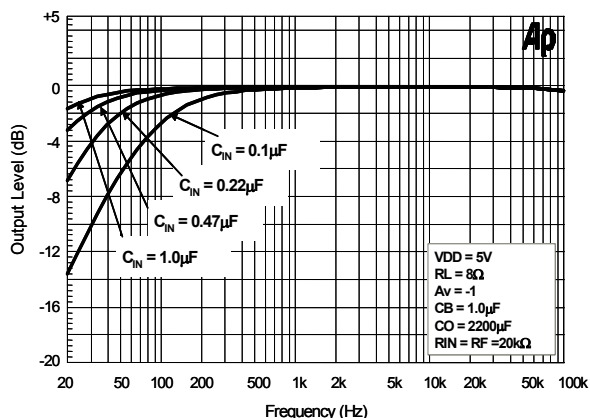

Figure 18. Output Level vs. Frequency

Typical Performance Characteristics (Continued)

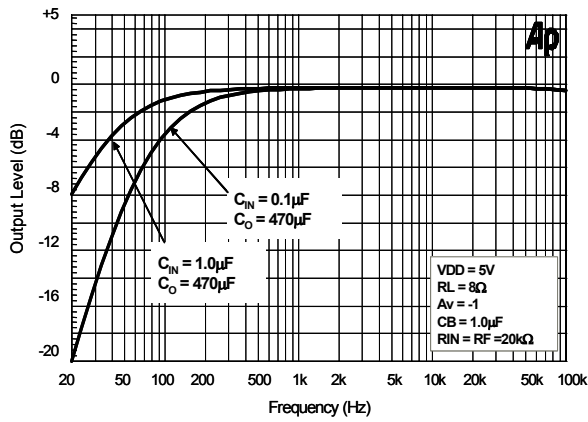

Figure 19. Output Level vs. Frequency

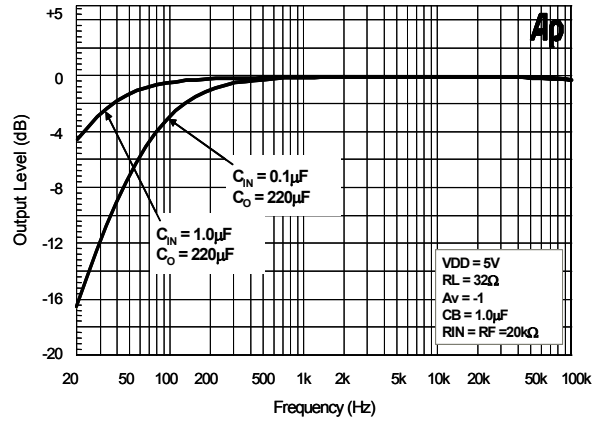

Figure 20. Output Level vs. Frequency

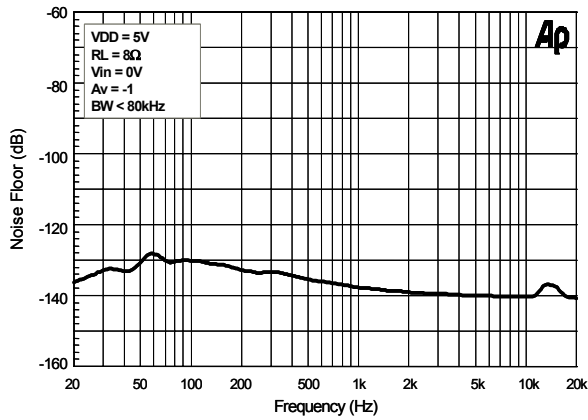

Figure 21. Noise Floor

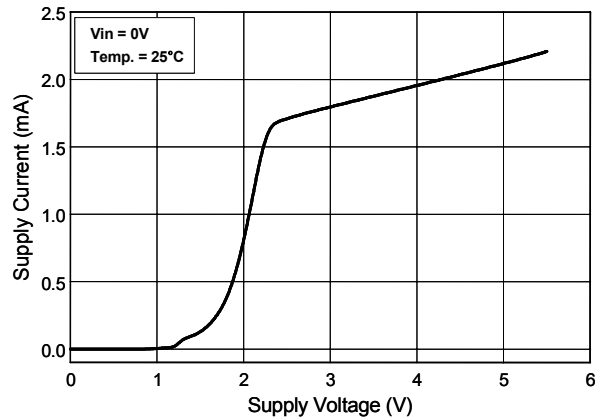

Figure 22. Supply Current vs. Supply Voltage

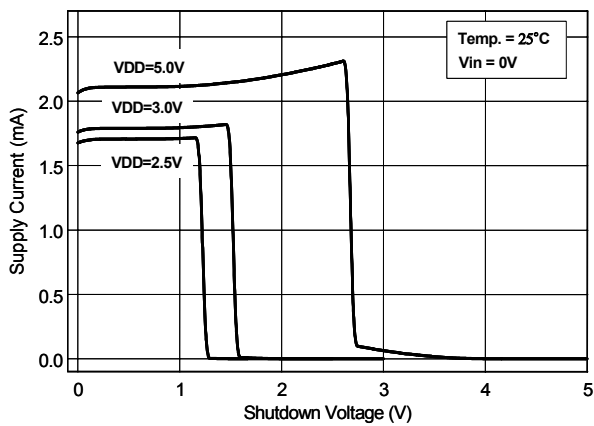

Figure 23. Supply Current vs. Shutdown Voltage

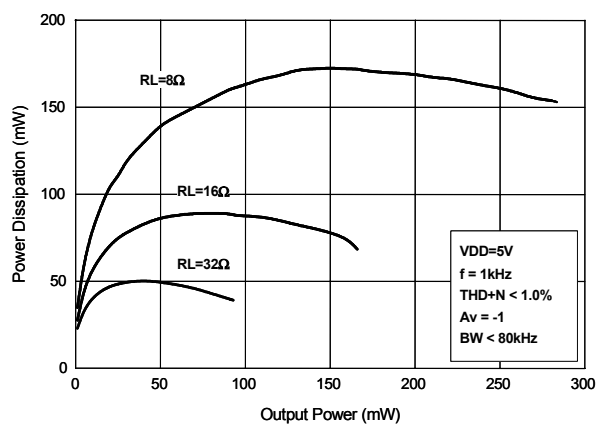

Figure 24. Power Dissipation vs. Output Power

Typical Performance Characteristics (Continued)

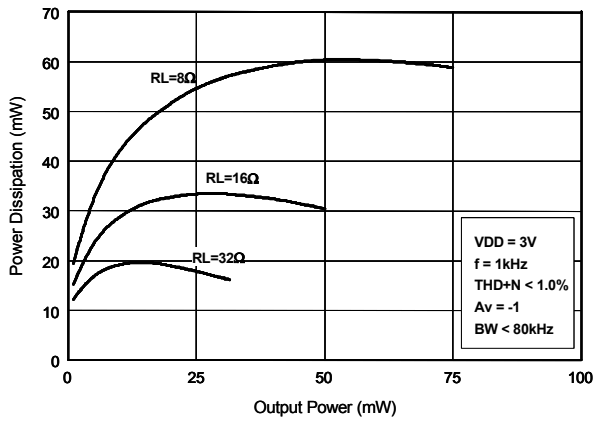

Figure 25. Power Dissipation vs. Output Power

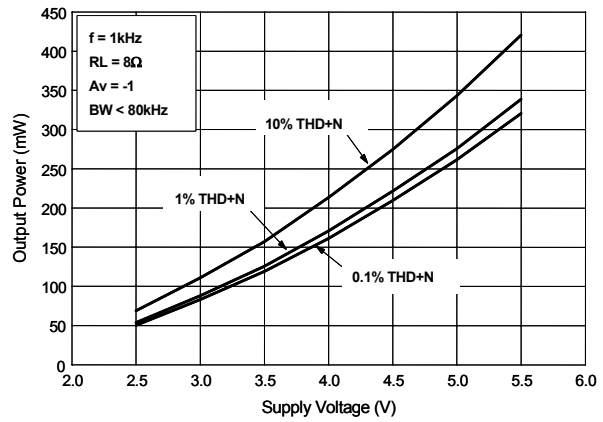

Figure 26. Output Power vs. Supply Voltage

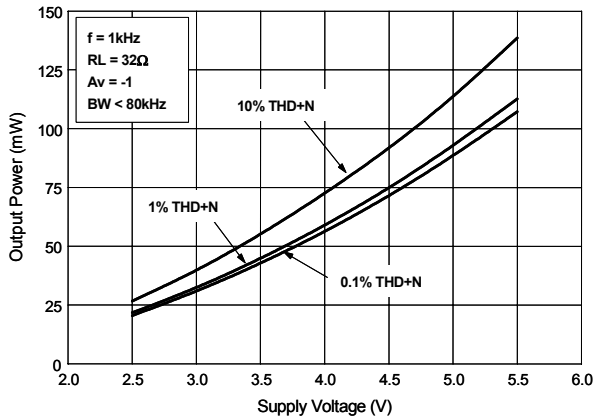

Figure 27. Output Power vs. Supply Voltage

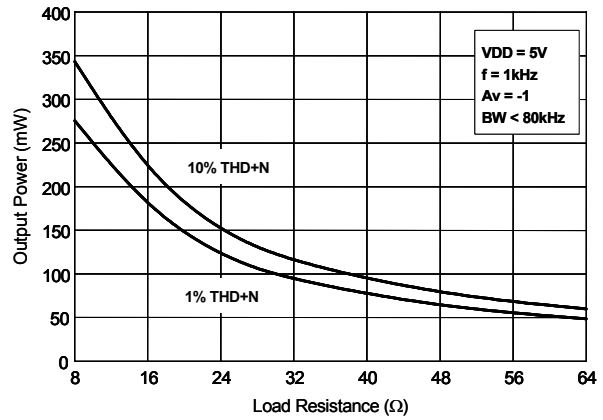

Figure 28. Output Power vs. Load Resistance

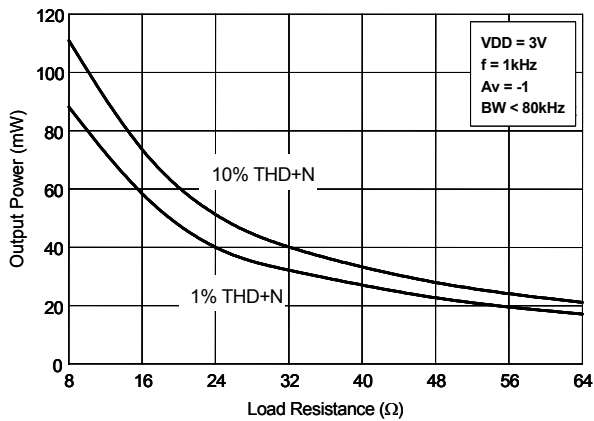

Figure 29. Output Power vs. Load Resistance

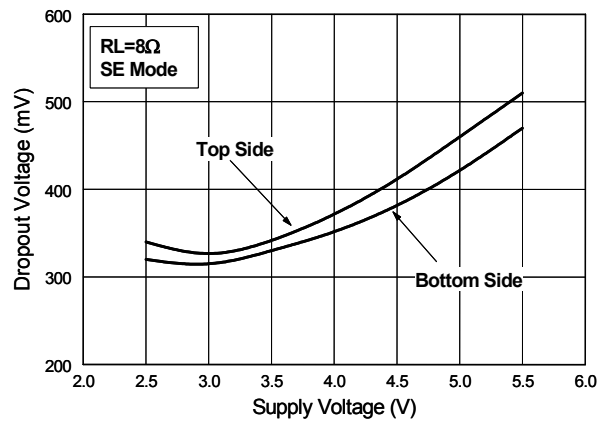

Figure 30. Drop Voltage vs. Supply Voltage

Typical Performance Characteristics (Continued)

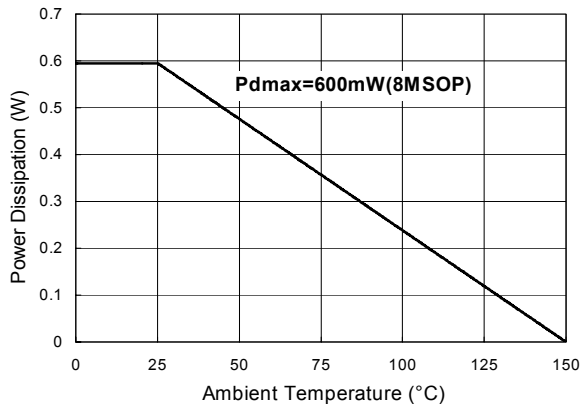

Figure 31. Power Derating Curve

Application Informations

Power Supply Bypassing

Selection of proper power supply bypassing is critical to obtaining lower noise as well as higher power supply rejection. Capacitors of the largest possible size may help to increase immunity to supply noise. However, taking into account economical design, attaching 10 μ F electrolytic capacitor or tantalum capacitor with 0.1 μ F ceramic capacitor as closely as possible to the VDD pin is sufficient to obtain a good supply noise rejection.

Single Ended Mode of Operation

The FAN7005 offers SE(Single Ended) operation. SE mode is adequate for head-phone load. The output power of SE mode is expressed as follows :

$$P_{SE} = \frac{V_P^2}{8 \cdot R_L} \quad (1)$$

To use the amplifier in SE mode, the output DC voltage must be blocked not to increase power consumption. Thus, the load is tied to the output via the output DC blocking capacitor. Capacitor size can be chosen using above f_{-3dB} equation. For example, assuming the load impedance is 32 Ω , a 248.8 μ F capacitor guarantees 20Hz signal transmission to the load without gain reduction. Refer to the Typical Performance Characteristics curves.

Shutdown Function

In order to reduce power consumption while not in use, the FAN7005 contains a shutdown pin(pin#3 @8MSOP) to turn off the amplifier's bias circuitry externally. This shutdown feature turns the amplifier off when a logic high is placed on the shutdown pin. The trigger point between a logic low and logic high level is typically half the supply voltage. It is best to switch between ground and supply to provide maximum device performance. By switching the shutdown pin to the VDD, the FAN7005's supply current draw will be minimized in idle mode. While the device will be disabled with shutdown pin voltages less than VDD, the idle current may be greater than the typical value of 0.1 μ A. In either case, the shutdown pin should be tied to a defined voltage because leaving the shutdown pin floating may result in an unwanted shutdown. In many applications, a micro controller or microprocessor output is used to control the shutdown circuitry, providing a quick, smooth transition into shutdown. Another solution is to use a single pole, single throw switch in conjunction with an external pull up resistor. When the switch is closed, the shutdown pin is connected to ground and enables the amplifier. If the switch is open, then the external pull up resistor will disable the FAN7005. This scheme guarantees that the shutdown pin will not float, which will prevent unwanted state changes.

Adaptive Q-Current Control Circuit

Among the different several kinds of analog amplifier, a class-AB satisfies moderate total harmonic distortion(THD) and power efficiency. In general, distortion proportionally reduces to the quiescent current(Q-current) of the output stage, but power efficiency is inversely proportional to it. To satisfy both needs, an adaptive Q-current control(AQC) technique is proposed. The AQC circuit increases the Q-current with respect to the amount of output distortion, whereas it is not activated when no input signal is applied and no output distortion is sensed.

Power Dissipation

Power dissipation is a major concern when using any power amplifier and must be thoroughly understood to ensure a successful design. Equation 2 states the maximum power dissipation point for a single-ended amplifier operating at a given supply voltage and driving a specified output load.

$$P_{DMAX} = \frac{V_{DD}^2}{2 \cdot \pi^2 \cdot R_L} \quad (2)$$

Since the FAN7005 has two operational amplifiers in one package, the maximum internal power dissipation point is twice that of the number which results from equation(2). Even with a large internal power dissipation, the FAN7005 does not require a heatsink over a large range of ambient temperature. From equation(2), assuming a 5V power supply and an 8 Ω load, the maximum power dissipation point is 158.8mW per amplifier. Thus the maximum package dissipation point is 316.6mW. The maximum power dissipation point obtained must not be greater than the power dissipation that results from equation(3) :

$$P_{D\text{MAX}} = \frac{T_{J\text{MAX}} - T_A}{R_{\text{thja}}} \quad (3)$$

For package 8MSOP(FAN7005MU), $R_{\text{thja}}=210^\circ\text{C/W}$, $T_{J\text{MAX}}=150^\circ\text{C}$ for the FAN7005.

Depending on the ambient temperature, T_A , of the system environment, equation(3) can be used to find the maximum internal power dissipation supported by the IC packaging. If the result of equation(2) is greater than that of equation(3), then either the supply voltage must be decreased, the load impedance increased or the T_A reduced. For the typical application of a 5V power supply, with an 8Ω load, the maximum ambient temperature possible without violating the maximum junction temperature is approximately 83.5°C provided that device operation is around the maximum power dissipation point. Power dissipation is a function of output power and thus, if typical operation is not around the maximum power dissipation point, the ambient temperature may be increased accordingly. Refer to the **Typical Performance Characteristics** curves for power dissipation information for lower output powers.

Proper Selection of External Components

Selection of external components when an using integrated power amplifier is critical for optimizing device and system performance. While the FAN7005 is tolerant of external component combinations, consideration must be given to component values to maximize overall system quality. The FAN7005 has a stable unity gain and this gives a designer maximum system flexibility. The FAN7005 should be used in low gain configurations to minimize THD+N values and maximize the signal to noise ratio. Low gain configurations require large input signals to obtain a given output power. Input signals equal to or greater than 1Vrms are available from sources such as audio codecs. Besides gain, one of the major considerations is the closed loop bandwidth of the amplifier. To a large extent, the bandwidth is dictated by the choice of external components shown in the **Typical Application Circuit**. Both the input coupling capacitor, C_I , and the output coupling capacitor, C_O , form first order high pass filters which limit low frequency response. These values should be chosen based on required frequency response for a few distinct responses.

Selection of Input and Output Capacitor Size

Large input and output capacitors are both expensive and space hungry for portable designs. Clearly a certain sized capacitor is needed to couple in low frequencies without severe attenuation. But in many cases the speakers used in portable systems, whether internal or external, have little ability to reproduce signals below 150Hz. Thus using large input and output capacitors may not increase system performance. In addition to system cost and size, click and pop performance is affected by the size of the input coupling capacitor, C_I . A larger input coupling capacitor requires more charge to reach its quiescent DC voltage (normally $V_{DD}/2$). This charge comes from the output via the feedback and is apt to create pops upon device enable. Thus, by minimizing the capacitor size based on the necessary low frequency response, turn on pops can be minimized. Besides minimizing the input and output capacitor sizes, careful consideration should be paid to the bypass capacitor value. Bypass capacitor, C_B is the most critical component for minimizing turn on pops since it determines how fast the FAN7005 turns on. The slower the FAN7005's outputs ramp to their quiescent DC voltage(normally $V_{DD}/2$), the smaller the turn on pop. Thus choosing C_B equal to $1.0\mu\text{F}$ along with a small value of C_I (in the range of $0.1\mu\text{F}$ to $0.39\mu\text{F}$), the shutdown function should be virtually click less and popless. While the device will function properly, (no oscillations or motor boating), with C_B equal to $0.1\mu\text{F}$, the device will be much more susceptible to turn on clicks and pops. Thus, a value of C_B equal to $0.1\mu\text{F}$ or larger is recommended in all but the most sensitive designs.

Using Low-ESR Capacitors, C_O

Low-ESR capacitors are recommended throughout this applications section. A real(as opposed to ideal) capacitor can be modeled simply as a resistor in series with an ideal capacitor. The voltage drop across this resistor minimizes the beneficial effects of the capacitor in the circuit. The lower the equivalent value of this resistance the more the real capacitor behaves like an ideal capacitor.

Typical Application Circuit

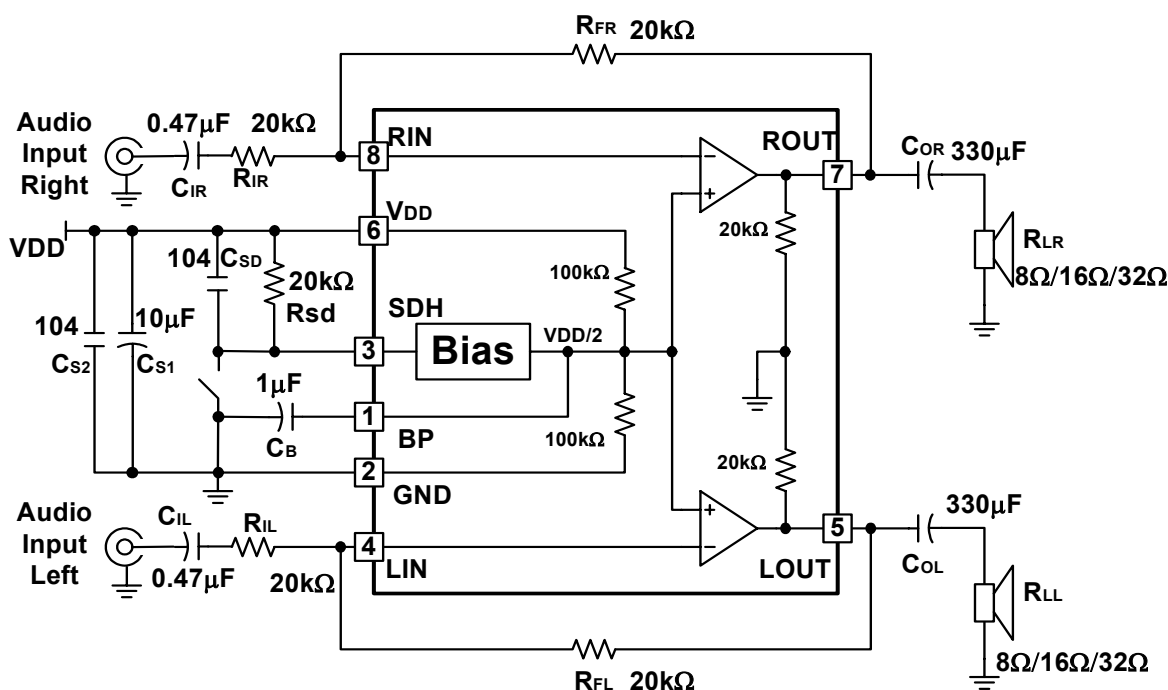

Components	Description
1. R _{IR} , R _{IL}	Inverting input resistance which sets the closed-loop gain in conduction with R _F . This resistor also forms a high pass filter with C _I at $f_c=1/2\pi R_I C_I$.
2. C _{IR} , C _{IL}	Input coupling capacitor which blocks the dc voltage at the amplifier's input terminals. Also creates a high pass filter with R _I at $f_c=1/2\pi R_I C_I$. Refer to the section, proper Selection of External Components , for an explanation of how to determine the value of C _I .
3. R _{FR} , R _{FL}	Feedback resistance which sets closed-loop gain in conduction with R _I .
4. C _{S1} , C _{S2}	Supply bypass capacitor which provides power supply filtering. Refer to the Application Information Section for proper placement and selection of the supply bypass capacitor.
5. C _B	Bypass pin capacitor which provides half the supply voltage filtering. Refer to the section, Proper Selection of External Components , for information concerning proper placement and selection of C _B .
6. C _{OR} , C _{OL}	Output coupling capacitor which blocks the dc voltage at the amplifier's output. Forms a high pass filter with R _L at $f_o=1/2\pi R_L C_O$.

Mechanical Dimensions

Package

Dimensions in millimeters

8MSOP

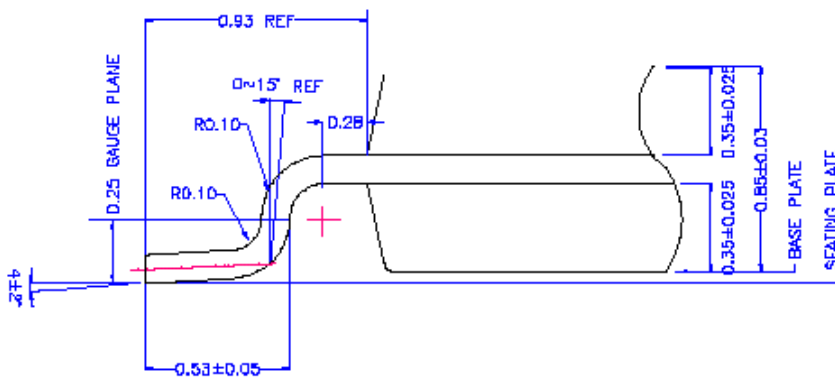
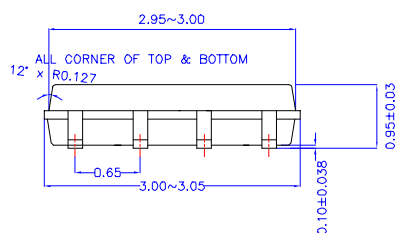
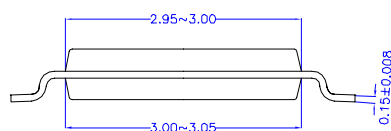
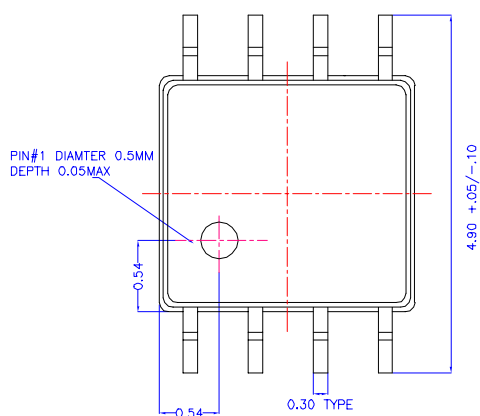

Mechanical Dimensions (Continued)

Package

Dimensions in millimeters

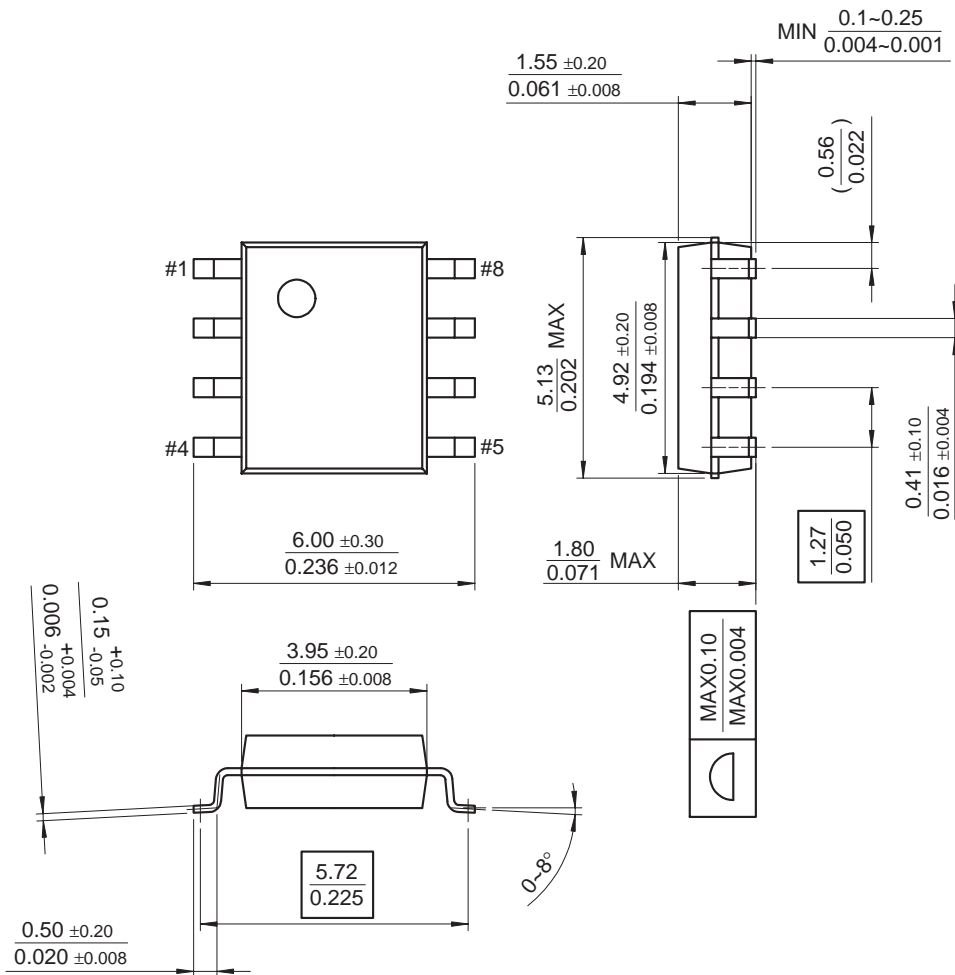
8SOP

Ordering Information

Device	Package	Operating Temperature	Packing
FAN7005MU	8MSOP	-40°C ~ +85°C	Tube
FAN7005M	8SOP		
FAN7005MUX	8MSOP		Tape&Reel
FAN7005MX	8SOP		

DISCLAIMER

FAIRCHILD SEMICONDUCTOR RESERVES THE RIGHT TO MAKE CHANGES WITHOUT FURTHER NOTICE TO ANY PRODUCTS HEREIN TO IMPROVE RELIABILITY, FUNCTION OR DESIGN. FAIRCHILD DOES NOT ASSUME ANY LIABILITY ARISING OUT OF THE APPLICATION OR USE OF ANY PRODUCT OR CIRCUIT DESCRIBED HEREIN; NEITHER DOES IT CONVEY ANY LICENSE UNDER ITS PATENT RIGHTS, NOR THE RIGHTS OF OTHERS.

LIFE SUPPORT POLICY

FAIRCHILD'S PRODUCTS ARE NOT AUTHORIZED FOR USE AS CRITICAL COMPONENTS IN LIFE SUPPORT DEVICES OR SYSTEMS WITHOUT THE EXPRESS WRITTEN APPROVAL OF THE PRESIDENT OF FAIRCHILD SEMICONDUCTOR CORPORATION. As used herein:

1. Life support devices or systems are devices or systems which, (a) are intended for surgical implant into the body, or (b) support or sustain life, and (c) whose failure to perform when properly used in accordance with instructions for use provided in the labeling, can be reasonably expected to result in a significant injury of the user.
2. A critical component in any component of a life support device or system whose failure to perform can be reasonably expected to cause the failure of the life support device or system, or to affect its safety or effectiveness.