

General Description

The AAT3216 MicroPower™ Low Dropout Linear Regulator is ideally suited for portable applications where low noise, extended battery life and small size are critical. The AAT3216 has been specifically designed for low output noise performance, fast transient response and high power supply rejection ratio (PSRR), making it ideal for powering sensitive RF circuits.

Other features include low quiescent current, typically 70µA, and low dropout voltage which is typically less than 200mV at full output current. The device is output short circuit protected and has a thermal shutdown circuit for additional protection under extreme conditions.

The AAT3216 also features a low-power shutdown mode for extended battery life. A Power-OK open-drain output signals when V_{OUT} is in regulation.

The AAT3216 is available in a space saving 5-pin SOT23 or 8-pin SC70-JW package in 12 factory programmed voltages of 1.2V, 1.5V, 1.8V, 2.0V, 2.3V, 2.5V, 2.7V, 2.8V, 2.85, 3.0V, 3.3V, or 3.5V.

Features

- Low Dropout - 200mV at 150mA
- Guaranteed 150mA Output
- High accuracy $\pm 1.5\%$
- 70µA Quiescent Current
- High Power Supply Ripple Rejection
- Low self noise
- PowerOK (POK) Output
- Fast line and load transient response
- Short circuit protection
- Over-Temperature protection
- Uses Low ESR ceramic capacitors
- Shutdown mode for longer battery life
- Low temperature coefficient
- 12 Factory programmed output voltages
- SOT23 5-pin or SC70-JW 8-pin package

Applications

- Cellular Phones
- Notebook Computers
- Desktop Computers
- Portable Communication Devices
- Personal Portable Electronics
- Digital Cameras

Typical Application

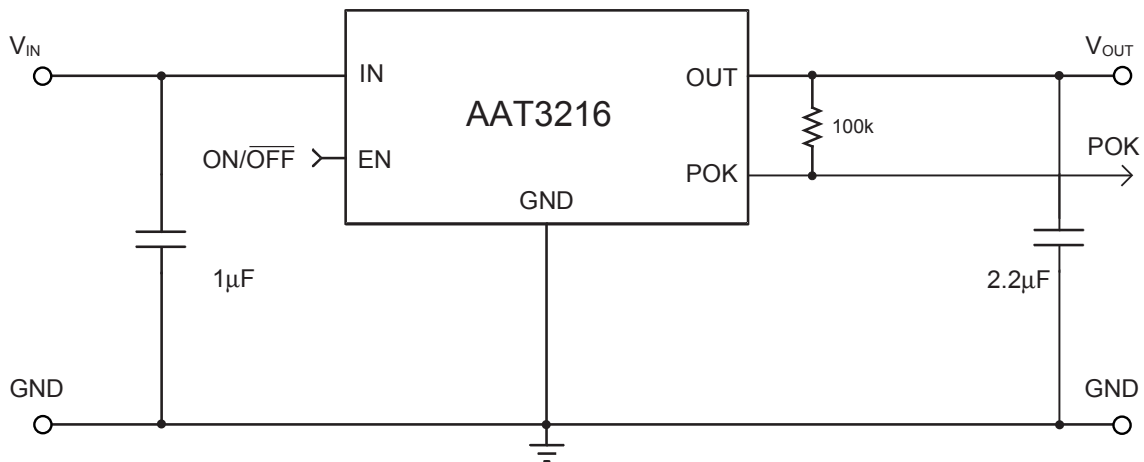

Pin Descriptions

Pin #		Symbol	Function
SOT23-5	SC70JW-8		
1	5, 6	IN	Input voltage pin - should be decoupled with 1 μ F or greater capacitor.
2	8	GND	Ground connection pin
3	7	EN	Enable pin - this pin should not be left floating. When pulled low the PMOS pass transistor turns off and all internal circuitry enters low-power mode, consuming less than 1 μ A.
4	1	POK	Power-OK Output. This open-drain output is low when OUT is out of regulation. Connect a pull up resistor from POK to OUT or IN.
5	2, 3, 4	OUT	Output pin - should be decoupled with 2.2 μ F ceramic capacitor.

Pin Configuration

**SOT23-5
(Top View)**

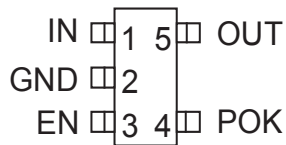

**SC70JW-8
(Top View)**

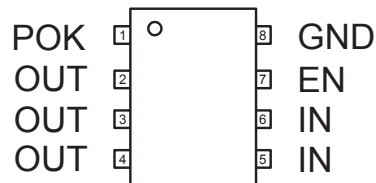

Absolute Maximum Ratings (T_A=25°C unless otherwise noted)

Symbol	Description	Value	Units
V _{IN, POK}	Input Voltage, POK	6	V
I _{OUT}	DC Output Current	P _D /(V _{IN} -V _O)	mA
T _J	Operating Junction Temperature Range	-40 to 150	°C

Note: Stresses above those listed in Absolute Maximum Ratings may cause permanent damage to the device. Functional operation at conditions other than the operating conditions specified is not implied. Only one Absolute Maximum rating should be applied at any one time.

Thermal Information

Symbol	Description	Rating	Units
Θ _{JA}	Maximum Thermal Resistance ¹ (SOT23-5, SC70JW-8)	190	°C/W
P _D	Maximum Power Dissipation ¹ (SOT23-5, SC70JW-8)	526	mW

Note 1: Mounted on a demo board.

Recommended Operating Conditions

Symbol	Description	Rating	Units
V _{IN}	Input Voltage ²	(V _{OUT} + V _{DO}) to 5.5	V
T	Ambient Temperature Range	-40 to +85	°C

Note 2: To calculate minimum input voltage, use the following equation: V_{IN(MIN)} = V_{OUT(MAX)} + V_{DO(MAX)} as long as V_{IN} ≥ 2.5V.

Electrical Characteristics ($V_{IN}=V_{OUT(NOM)}+1V$ for V_{OUT} options greater than 1.5V. $V_{IN}= 2.5$ for $V_{OUT}\leq 1.5V$. $I_{OUT}=1mA$, $C_{OUT}=2.2\mu F$, $C_{IN}=1\mu f$, $T_A = -40$ to $85^\circ C$ unless otherwise noted. Typical values are at $T_A=25^\circ C$)

Symbol	Description	Conditions	Min	Typ	Max	Units	
V_{OUT}	Output Voltage Tolerance	$I_{OUT} = 1mA$ to $150mA$	$T_A=25^\circ C$	-1.5		1.5	%
			$T_A=-40$ to $85^\circ C$	-2.5		2.5	%
I_{OUT}	Output Current	$V_{OUT} > 1.2V$	150			mA	
V_{DO}	Dropout Voltage ^{1,2}	$I_{OUT} = 150mA$		200	300	mV	
I_{SC}	Short Circuit Current	$V_{OUT} < 0.4V$		600		mA	
I_Q	Ground Current	$V_{IN} = 5V$, No load, $EN = V_{IN}$		70	125	μA	
I_{SD}	Shutdown Current	$V_{IN} = 5V$, $EN = 0V$			1	μA	
$\Delta V_{OUT}/V_{OUT} \cdot \Delta V_{IN}$	Line Regulation ³	$V_{IN} = V_{OUT} + 1$ to $5.0V$			0.09	%/V	
$\Delta V_{OUT}(\text{line})$	Dynamic Line Regulation	$V_{IN}=V_{OUT}+1V$ to $V_{OUT}+2V$, $I_{OUT}=150mA$, $T_R/T_F = 2\mu s$		5		mV	
$\Delta V_{OUT}(\text{load})$	Dynamic Load Regulation	$I_{OUT} = 1mA$ to $150mA$, $T_R < 5\mu s$		30		mV	
$V_{EN(L)}$	Enable Threshold Low				0.6	V	
$V_{EN(H)}$	Enable Threshold High		1.5			V	
I_{EN}	Leakage Current on Enable Pin	$V_{EN} = 5V$			1	μA	
V_{POK}	POK Trip Threshold	V_{OUT} rising, $T_A = 25^\circ C$	90	94	98	% of V_{OUT}	
V_{POKHYS}	POK Hysteresis			1		% of V_{OUT}	
$V_{POK(OL)}$	POK Output Voltage Low	$I_{SINK} = 1mA$			0.4	V	
I_{POK}	POK Output Leakage Current	$V_{POK} < 5.5V$, V_{OUT} in regulation			1	μA	
PSRR	Power Supply Rejection Ratio	$I_{OUT}=10mA$	1 kHz		65	dB	
			10kHz		45		
			1MHz		42		
T_{SD}	Over Temp Shutdown Threshold			145		$^\circ C$	
T_{HYS}	Over Temp Shutdown Hysteresis			12		$^\circ C$	
e_N	Output Noise	Noise Power BW = 300Hz-50kHz		250		$\mu V_{rms}/rtHz$	
TC	Output Voltage Temp. Coeff.			22		ppm/ $^\circ C$	

Note 1: V_{DO} is defined as $V_{IN} - V_{OUT}$ when V_{OUT} is 98% of nominal.

Note 2: For $V_{OUT} < 2.3V$, $V_{DO} = 2.5V - V_{OUT}$.

Note 3: $C_{IN} = 10\mu F$

Typical Characteristics

(Unless otherwise noted, $V_{IN} = 5V$, $T_A = 25^\circ C$)

Dropout Voltage vs. Temperature

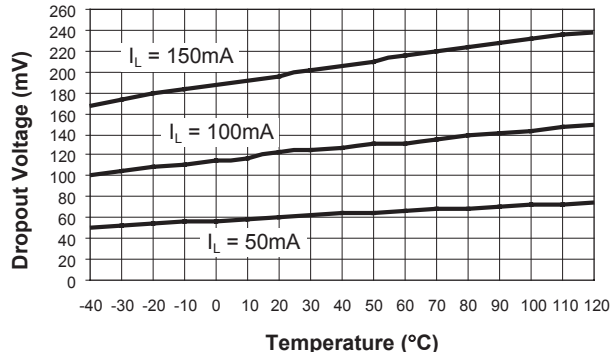

Dropout Characteristics

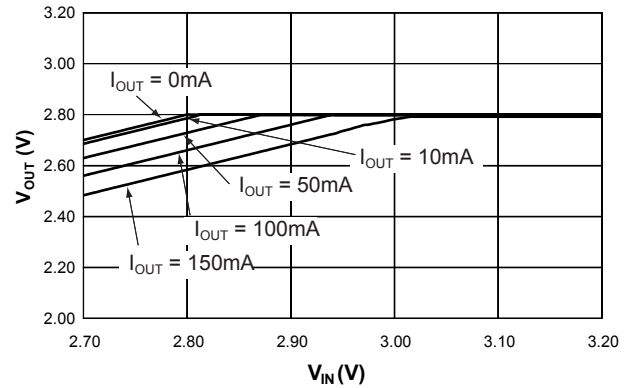

Dropout Voltage vs. Output Current

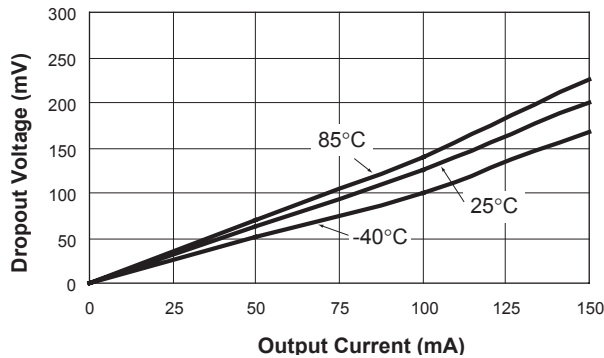

Ground Current vs. Input Voltage

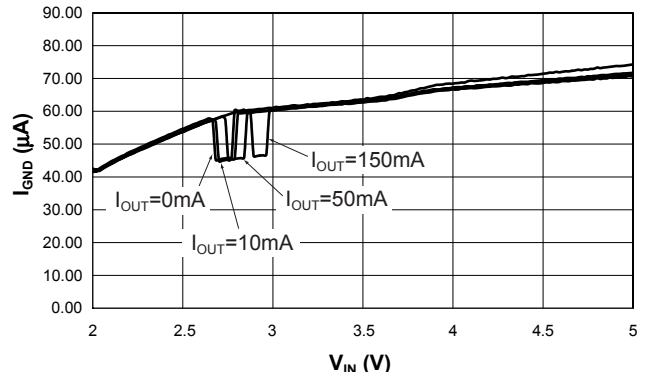

Quiescent Current vs. Temperature

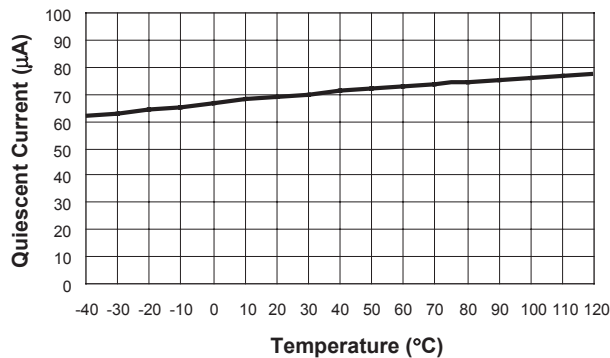

Output Voltage vs. Temperature

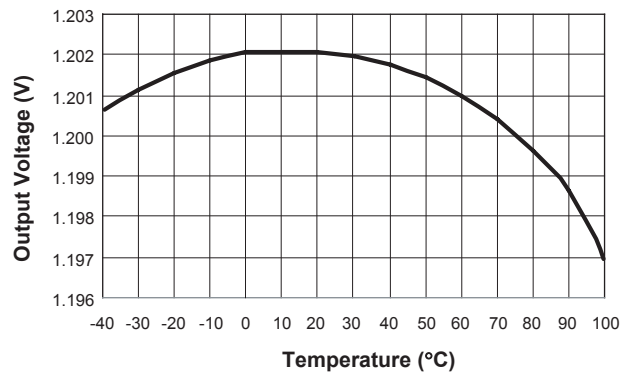

Typical Characteristics

(Unless otherwise noted, $V_{IN} = 5V$, $T_A = 25^\circ C$)

Turn On Time and POK Delay

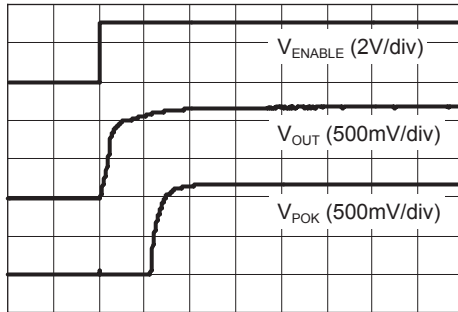

Time (10µs/div)

Turn Off Time with POK Delay

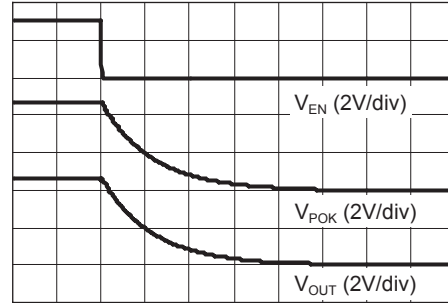

Time (200µs/div)

Line Transient Response

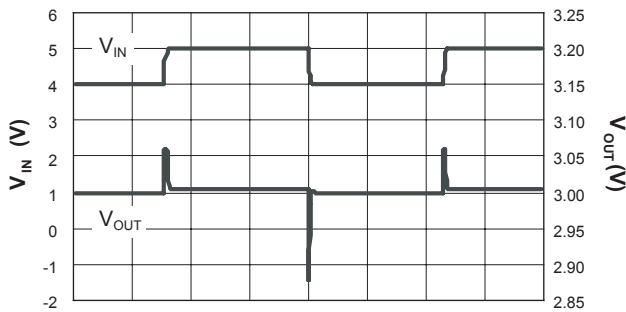

Time (100 µs/div)

Load Transient Response

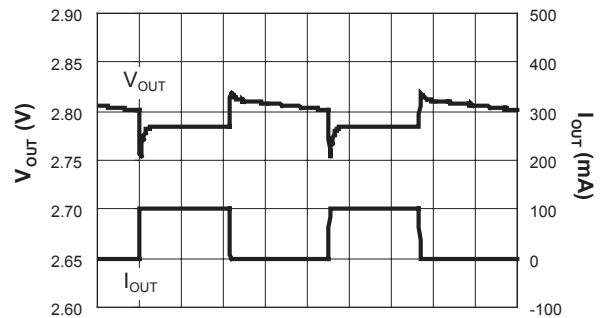

100 µs/div

Over Current Protection

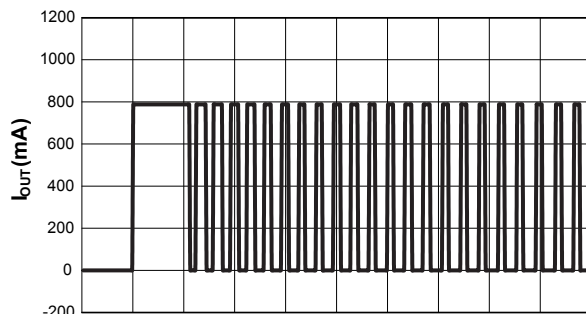

Time (20 ms/div)

POK Output Response

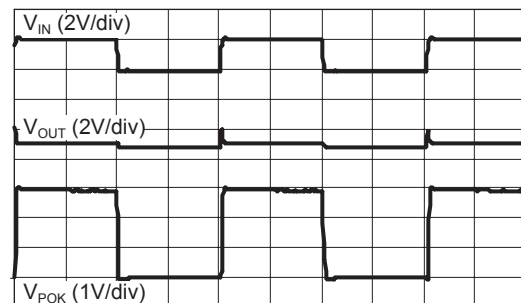

Time (200µs/div.)

Typical Characteristics

(Unless otherwise noted, $V_{IN} = 5V$, $T_A = 25^\circ C$)

AAT3216 Self Noise

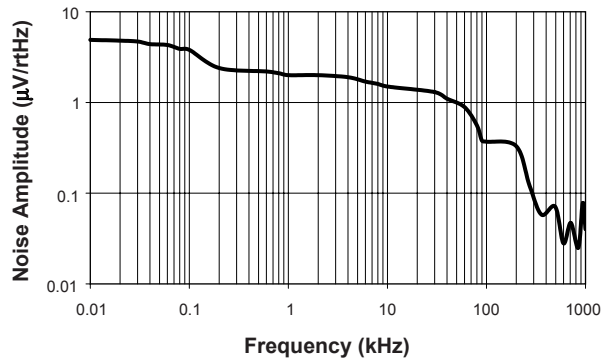

$V_{EN(H)}$ and $V_{EN(L)}$ vs. V_{IN}

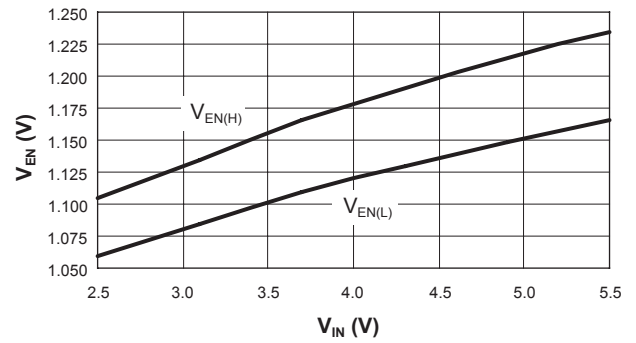

Functional Block Diagram

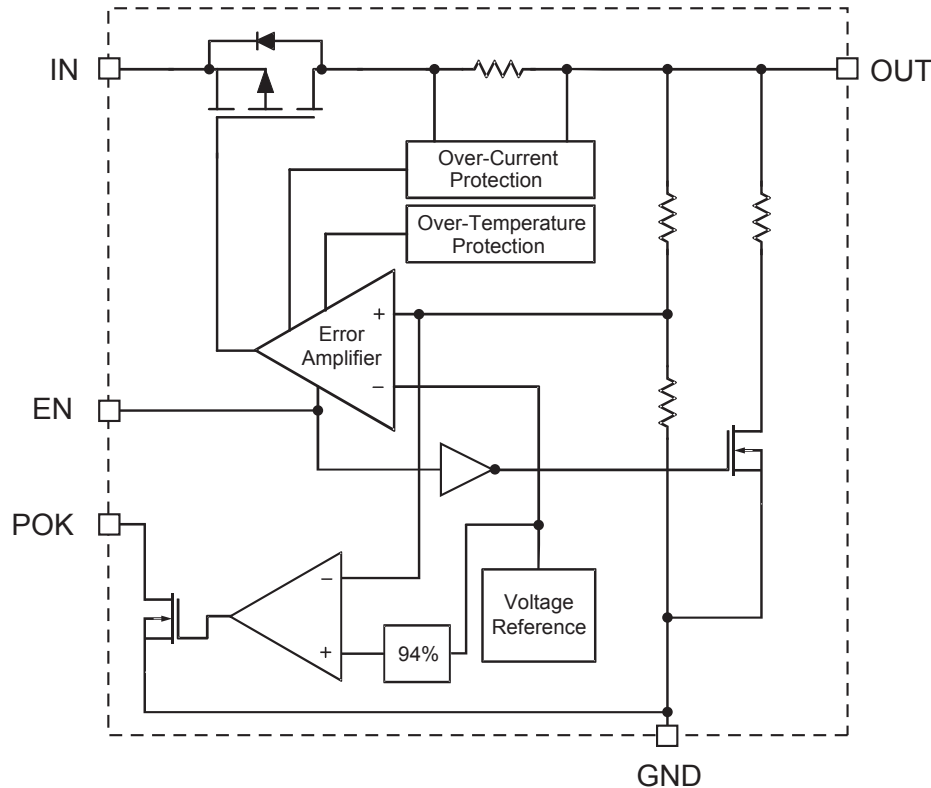

Functional Description

The AAT3216 is intended for LDO regulator applications where output current load requirements range from no load to 150mA.

The advanced circuit design of the AAT3216 provides excellent transient response and fast turn-on ability. The LDO regulator output has been specifically optimized to function with low cost, low ESR ceramic capacitors. However, the design will allow for operation over a wide range of capacitor types.

The AAT3216 has an integrated Power-OK comparator which indicates when the output is out of regulation.

The device enable circuit is provided to shutdown the LDO regulator for power conservation in portable products. The enable circuit has an additional output capacitor discharge circuit to assure sharp application circuit turn off upon device shutdown.

This LDO regulator has complete short circuit and thermal protection. The integral combination of these two internal protection circuits give the AAT3216 a comprehensive safety system during extreme adverse operating conditions. Device power dissipation is limited to the package type and thermal dissipation properties. Refer to the thermal considerations discussion in the section for details on device operation at maximum output current loads.

Applications Information

To assure the maximum possible performance is obtained from the AAT3216, please refer to the following application recommendations.

Input Capacitor

Typically a 1 μ F or larger capacitor is recommended for C_{IN} in most applications. A C_{IN} capacitor is not required for basic LDO regulator operation. However, if the AAT3216 is physically located more than 3 centimeters from an input power source, a C_{IN} capacitor will be needed for stable operation. C_{IN} should be located as close to the device V_{IN} pin as practically possible. C_{IN} values greater than 1 μ F will offer superior input line transient response and will assist in maximizing the highest possible power supply ripple rejection.

Ceramic, tantalum or aluminum electrolytic capacitors may be selected for C_{IN} . There is no specific capacitor ESR requirement for C_{IN} . However, for 150mA LDO regulator output operation, ceramic capacitors are recommended for C_{IN} due to their inherent capability over tantalum capacitors to withstand input current surges from low impedance sources such as batteries in portable devices.

Output Capacitor

For proper load voltage regulation and operational stability, a capacitor is required between pins V_{OUT} and GND. The C_{OUT} capacitor connection to the LDO regulator ground pin should be made as direct as practically possible for maximum device performance.

The AAT3216 has been specifically designed to function with very low ESR ceramic capacitors. For best performance, ceramic capacitors are recommended.

Typical output capacitor values for maximum output current conditions range from 1 μ F to 10 μ F. Applications utilizing the exceptionally low output noise and optimum power supply ripple rejection characteristics of the AAT3216 should use 2.2 μ F or greater for C_{OUT} . If desired, C_{OUT} may be increased without limit.

In low output current applications where output load is less than 10mA, the minimum value for C_{OUT} can be as low as 0.47 μ F.

Capacitor Characteristics

Ceramic composition capacitors are highly recommended over all other types of capacitors for use with the AAT3216. Ceramic capacitors offer many advantages over their tantalum and aluminum electrolytic counterparts. A ceramic capacitor typically has very low ESR, is lower cost, has a smaller PCB footprint and is non-polarized. Line and load transient response of the LDO regulator is improved by using low ESR ceramic capacitors. Since ceramic capacitors are non-polarized, they are not prone to incorrect connection damage.

Equivalent Series Resistance (ESR): ESR is a very important characteristic to consider when selecting a capacitor. ESR is the internal series resistance associated with a capacitor, which includes lead resistance, internal connections, size and area, material composition and ambient temperature. Typically capacitor ESR is measured in milliohms for ceramic capacitors and can range to more than several ohms for tantalum or aluminum electrolytic capacitors.

Ceramic Capacitor Materials: Ceramic capacitors less than 0.1 μ F are typically made from NPO or COG materials. NPO and COG materials are typically tight tolerance very stable over temperature. Larger capacitor values are typically composed of X7R, X5R, Z5U and Y5V dielectric materials. Large ceramic capacitors, typically greater than 2.2 μ F are often available in the low cost Y5V and Z5U dielectrics. These two material types are not recommended for use with LDO regulators since the capacitor tolerance can vary more than $\pm 50\%$ over the operating temperature range of the device. A 2.2 μ F Y5V capacitor could be reduced to 1 μ F over temperature, this could cause problems for circuit operation. X7R and X5R dielectrics are much more desirable. The temperature tolerance of X7R dielectric is better than $\pm 15\%$.

Capacitor area is another contributor to ESR. Capacitors which are physically large in size will have a lower ESR when compared to a smaller sized capacitor of an equivalent material and capacitance value. These larger devices can improve circuit transient response when compared to an equal value capacitor in a smaller package size.

Applications Information

Consult capacitor vendor data sheets carefully when selecting capacitors for LDO regulators.

POK Output

The AAT 3216 features an integrated Power-OK comparator which can be used as an error flag. The POK open-drain output goes low when OUT is 6% below its nominal regulation voltage. Connect a pull-up resistor from POK to OUT or IN. A delayed POK signal can be implemented with a capacitor in parallel with the pull-up resistor.

Enable Function

The AAT3216 features an LDO regulator enable/disable function. This pin (EN) is active high and is compatible with CMOS logic. To assure the LDO regulator will switch on, the EN turn on control level must be greater than 2.0 volts. The LDO regulator will go into the disable shutdown mode when the voltage on the EN pin falls below 0.6 volts. If the enable function is not needed in a specific application, it may be tied to V_{IN} to keep the LDO regulator in a continuously on state.

When the LDO regulator is in the shutdown mode, an internal 1.5k Ω resistor is connected between V_{OUT} and GND. This is intended to discharge C_{OUT} when the LDO regulator is disabled. The internal 1.5k Ω has no adverse effect on device turn on time.

Short Circuit Protection

The AAT3216 contains an internal short circuit protection circuit that will trigger when the output load current exceeds the internal threshold limit. Under short circuit conditions the output of the LDO regulator will be current limited until the short circuit condition is removed from the output or LDO regulator package power dissipation exceeds the device thermal limit.

Thermal Protection

The AAT3216 has an internal thermal protection circuit which will turn on when the device die temperature exceeds 150°C. The internal thermal protection circuit will actively turn off the LDO regulator

output pass device to prevent the possibility of over temperature damage. The LDO regulator output will remain in a shutdown state until the internal die temperature falls back below the 150°C trip point.

The combination and interaction between the short circuit and thermal protection systems allow the LDO regulator to withstand indefinite short circuit conditions without sustaining permanent damage.

No-Load Stability

The AAT3216 is designed to maintain output voltage regulation and stability under operational no-load conditions. This is an important characteristic for applications where the output current may drop to zero.

Reverse Output to Input Voltage Conditions and Protection

Under normal operating conditions a parasitic diode exists between the output and input of the LDO regulator. The input voltage should always remain greater than the output load voltage maintaining a reverse bias on the internal parasitic diode. Conditions where V_{OUT} might exceed V_{IN} should be avoided since this would forward bias the internal parasitic diode and allow excessive current flow into the V_{OUT} pin possibly damaging the LDO regulator.

In applications where there is a possibility of V_{OUT} exceeding V_{IN} for brief amounts of time during normal operation, the use of a larger value C_{IN} capacitor is highly recommended. A larger value of C_{IN} with respect to C_{OUT} will effect a slower C_{IN} decay rate during shutdown, thus preventing V_{OUT} from exceeding V_{IN} . In applications where there is a greater danger of V_{OUT} exceeding V_{IN} for extended periods of time, it is recommended to place a schottky diode across V_{IN} to V_{OUT} (connecting the cathode to V_{IN} and anode to V_{OUT}). The Schottky diode forward voltage should be less than 0.45 volts.

Thermal Considerations and High Output Current Applications

The AAT3216 is designed to deliver a continuous output load current of 150mA under normal operating conditions.

Applications Information

The limiting characteristic for the maximum output load current safe operating area is essentially package power dissipation and the internal preset thermal limit of the device. In order to obtain high operating currents, careful device layout and circuit operating conditions need to be taken into account.

The following discussions will assume the LDO regulator is mounted on a printed circuit board utilizing the minimum recommended footprint as stated in the layout considerations section of the document.

At any given ambient temperature (T_A) the maximum package power dissipation can be determined by the following equation:

$$P_{D(MAX)} = [T_{J(MAX)} - T_A] / \Theta_{JA}$$

Constants for the AAT3216 are $T_{J(MAX)}$, the maximum junction temperature for the device which is 125°C and $\Theta_{JA} = 190^\circ\text{C/W}$, the package thermal resistance. Typically, maximum conditions are calculated at the maximum operating temperature where $T_A = 85^\circ\text{C}$, under normal ambient conditions $T_A = 25^\circ\text{C}$. Given $T_A = 85^\circ$, the maximum package power dissipation is 211mW. At $T_A = 25^\circ\text{C}$, the maximum package power dissipation is 526mW.

The maximum continuous output current for the AAT3216 is a function of the package power dissipation and the input to output voltage drop across the LDO regulator. Refer to the following simple equation:

$$I_{OUT(MAX)} < P_{D(MAX)} / (V_{IN} - V_{OUT})$$

For example, if $V_{IN} = 5\text{V}$, $V_{OUT} = 3\text{V}$ and $T_A = 25^\circ$, $I_{OUT(MAX)} < 264\text{mA}$. If the output load current were to exceed 264mA or if the ambient temperature were to increase, the internal die temperature will increase. If the condition remained constant, the LDO regulator thermal protection circuit will activate.

To figure what the maximum input voltage would be for a given load current refer to the following equation. This calculation accounts for the total power dissipation of the LDO Regulator, including that caused by ground current.

$$P_{D(MAX)} = (V_{IN} - V_{OUT})I_{OUT} + (V_{IN} \times I_{GND})$$

This formula can be solved for V_{IN} to determine the maximum input voltage.

$$V_{IN(MAX)} = (P_{D(MAX)} + (V_{OUT} \times I_{OUT})) / (I_{OUT} + I_{GND})$$

The following is an example for an AAT3216 set for a 2.5 volt output:

From the discussion above, $P_{D(MAX)}$ was determined to equal 526mW at $T_A = 25^\circ\text{C}$.

$$V_{OUT} = 2.5 \text{ volts}$$

$$I_{OUT} = 150\text{mA}$$

$$I_{GND} = 150\mu\text{A}$$

$$V_{IN(MAX)} = (526\text{mW} + (2.5\text{V} \times 150\text{mA})) / (150\text{mA} + 150\mu\text{A})$$

$$V_{IN(MAX)} = 6.00\text{V}$$

Thus, the AAT3216 can sustain a constant 2.5V output at a 150mA load current as long as V_{IN} is $\leq 6.00\text{V}$ at an ambient temperature of 25°C. 6.0V is the absolute maximum voltage where an AAT3216 would never be operated, thus at 25°C, the device would not have any thermal concerns or operational $V_{IN(MAX)}$ limits.

This situation can be different at 85°C. The following is an example for an AAT3216 set for a 2.5 volt output at 85°C:

From the discussion above, $P_{D(MAX)}$ was determined to equal 211mW at $T_A = 85^\circ\text{C}$.

$$V_{OUT} = 2.5 \text{ volts}$$

$$I_{OUT} = 150\text{mA}$$

$$I_{GND} = 150\mu\text{A}$$

$$V_{IN(MAX)} = (211\text{mW} + (2.5\text{V} \times 150\text{mA})) / (150\text{mA} + 150\mu\text{A})$$

$$V_{IN(MAX)} = 3.90\text{V}$$

Higher input to output voltage differentials can be obtained with the AAT3216, while maintaining device functions within the thermal safe operating area. To accomplish this, the device thermal resistance must be reduced by increasing the heat sink area or by operating the LDO regulator in a duty cycled mode.

For example, an application requires $V_{IN} = 4.2\text{V}$ while $V_{OUT} = 2.5\text{V}$ at a 150mA load and $T_A = 85^\circ\text{C}$. V_{IN} is greater than 3.90V, which is the maximum safe continuous input level for $V_{OUT} = 2.5\text{V}$ at 150mA for $T_A = 85^\circ\text{C}$. To maintain this high input voltage and output current level, the LDO regulator

must be operated in a duty cycled mode. Refer to the following calculation for duty cycle operation:

$P_{D(MAX)}$ is assumed to be 211mW

$$I_{GND} = 150\mu A$$

$$I_{OUT} = 150mA$$

$$V_{IN} = 4.2 \text{ volts}$$

$$V_{OUT} = 2.5 \text{ volt}$$

$$\%DC = 100(P_{D(MAX)} / ((V_{IN} - V_{OUT})I_{OUT} + (V_{IN} \times I_{GND})))$$

$$\%DC = 100(211mW / ((4.2V - 2.5V)150mA + (4.2V \times 150\mu A)))$$

$$\%DC = 85.54\%$$

For a 150mA output current and a 2.7volt drop across the AAT3216 at an ambient temperature of 85°C, the maximum on time duty cycle for the device would be 85.54%.

The following family of curves show the safe operating area for duty cycled operation from ambient room temperature to the maximum operating level.

Device Duty Cycle vs. V_{DROP}
 $V_{OUT} = 2.5V @ 25^\circ C$

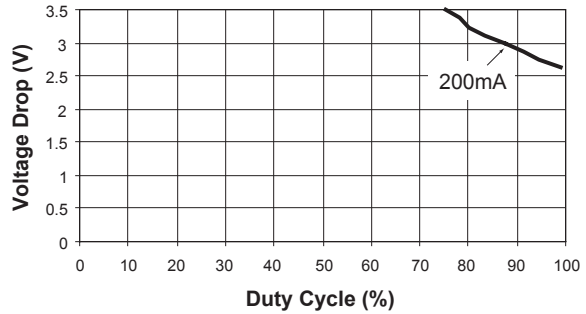

Device Duty Cycle vs. V_{DROP}
 $V_{OUT} = 2.5V @ 50^\circ C$

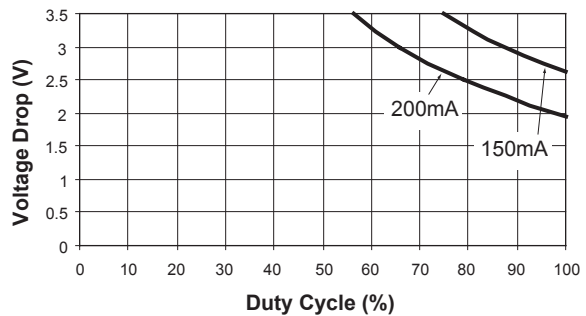

Device Duty Cycle vs. V_{DROP}
 $V_{OUT} = 2.5V @ 85^\circ C$

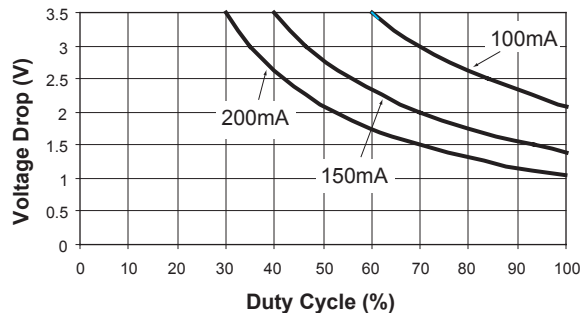

Applications Information

High Peak Output Current Applications

Some applications require the LDO regulator to operate at continuous nominal level with short duration high current peaks. The duty cycles for both output current levels must be taken into account. To do so, one would first need to calculate the power dissipation at the nominal continuous level, then factor in the additional power dissipation due to the short duration high current peaks.

For example, a 2.5V system using a AAT3216IGV-2.5-T1 operates at a continuous 100mA load current level and has short 150mA current peaks. The current peak occurs for 378µs out of a 4.61ms period. It will be assumed the input voltage is 4.2V.

First the current duty cycle in percent must be calculated:

$$\begin{aligned} \% \text{ Peak Duty Cycle} &= X/100 = 378\mu\text{s}/4.61\text{ms} \\ \% \text{ Peak Duty Cycle} &= 8.2\% \end{aligned}$$

The LDO Regulator will be under the 100mA load for 91.8% of the 4.61ms period and have 150mA peaks occurring for 8.2% of the time. Next, the continuous nominal power dissipation for the 100mA load should be determined then multiplied by the duty cycle to conclude the actual power dissipation over time.

$$\begin{aligned} P_{D(\text{MAX})} &= (V_{\text{IN}} - V_{\text{OUT}})I_{\text{OUT}} + (V_{\text{IN}} \times I_{\text{GND}}) \\ P_{D(100\text{mA})} &= (4.2\text{V} - 2.5\text{V})100\text{mA} + (4.2\text{V} \times 150\mu\text{A}) \\ P_{D(100\text{mA})} &= 170.6\text{mW} \end{aligned}$$

$$\begin{aligned} P_{D(91.8\% \text{D/C})} &= \% \text{DC} \times P_{D(100\text{mA})} \\ P_{D(91.8\% \text{D/C})} &= 0.918 \times 170.6\text{mW} \\ P_{D(91.8\% \text{D/C})} &= 156.6\text{mW} \end{aligned}$$

The power dissipation for 100mA load occurring for 91.8% of the duty cycle will be 156.6mW. Now the power dissipation for the remaining 8.2% of the duty cycle at the 150mA load can be calculated:

$$\begin{aligned} P_{D(\text{MAX})} &= (V_{\text{IN}} - V_{\text{OUT}})I_{\text{OUT}} + (V_{\text{IN}} \times I_{\text{GND}}) \\ P_{D(150\text{mA})} &= (4.2\text{V} - 2.5\text{V})150\text{mA} + (4.2\text{V} \times 150\mu\text{A}) \\ P_{D(150\text{mA})} &= 255.6\text{mW} \end{aligned}$$

$$\begin{aligned} P_{D(8.2\% \text{D/C})} &= \% \text{DC} \times P_{D(150\text{mA})} \\ P_{D(8.2\% \text{D/C})} &= 0.082 \times 255.6\text{mW} \\ P_{D(8.2\% \text{D/C})} &= 21\text{mW} \end{aligned}$$

The power dissipation for 150mA load occurring for 8.2% of the duty cycle will be 21mW. Finally, the two power dissipation levels can be summed to determine the total true power dissipation under the varied load.

$$\begin{aligned} P_{D(\text{total})} &= P_{D(100\text{mA})} + P_{D(150\text{mA})} \\ P_{D(\text{total})} &= 156.6\text{mW} + 21\text{mW} \\ P_{D(\text{total})} &= 177.6\text{mW} \end{aligned}$$

The maximum power dissipation for the AAT3216 operating at an ambient temperature of 85°C is 211mW. The device in this example will have a total power dissipation of 177.6mW. This is well within the thermal limits for safe operation of the device.

Ordering Information

Output Voltage	Package	Marking ¹	Part Number (Tape and Reel)
1.2V	SOT23-5	EAXYY	AAT3216IGV-1.2-T1
1.5V	SOT23-5	KJXYY	AAT3216IGV-1.5-T1
1.8V	SOT23-5		AAT3216IGV-1.8-T1
2.0V	SOT23-5		AAT3216IGV-2.0-T1
2.3V	SOT23-5		AAT3216IGV-2.3-T1
2.5V	SOT23-5	KKXYY	AAT3216IGV-2.5-T1
2.7V	SOT23-5		AAT3216IGV-2.7-T1
2.8V	SOT23-5	ELXYY	AAT3216IGV-2.8-T1
2.85V	SOT23-5	FSXYY	AAT3216IGV-2.85-T1
3.0V	SOT23-5		AAT3216IGV-3.0-T1
3.3V	SOT23-5	HQXYY	AAT3216IGV-3.3-T1
3.5V	SOT23-5	IYXYY	AAT3216IGV-3.5-T1
1.2V	SC70JW-8		AAT3216IJS-1.2-T1
1.5V	SC70JW-8		AAT3216IJS-1.5-T1
1.8V	SC70JW-8		AAT3216IJS-1.8-T1
2.0V	SC70JW-8		AAT3216IJS-2.0-T1
2.3V	SC70JW-8		AAT3216IJS-2.3-T1
2.5V	SC70JW-8		AAT3216IJS-2.5-T1
2.7V	SC70JW-8		AAT3216IJS-2.7-T1
2.8V	SC70JW-8		AAT3216IJS-2.8-T1
2.85V	SC70JW-8		AAT3216IJS-2.85-T1
3.0V	SC70JW-8	KGXYY	AAT3216IJS-3.0-T1
3.3V	SC70JW-8		AAT3216IJS-3.3-T1
3.5V	SC70JW-8		AAT3216IJS-3.5-T1

Note: Sample stock is generally held on all part numbers listed in **BOLD**.

Note 1: XYY = assembly and date code.

Package Information

SOT23-5

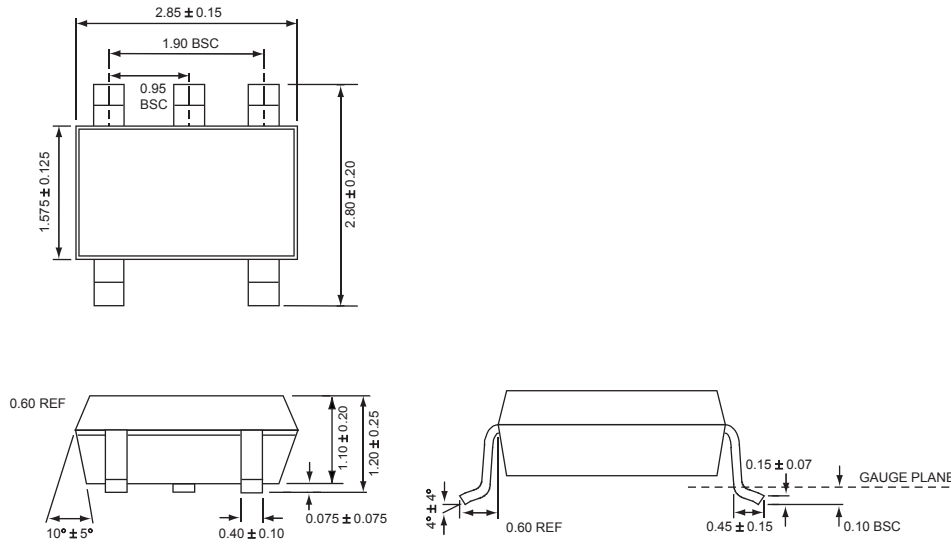

SC70JW-8

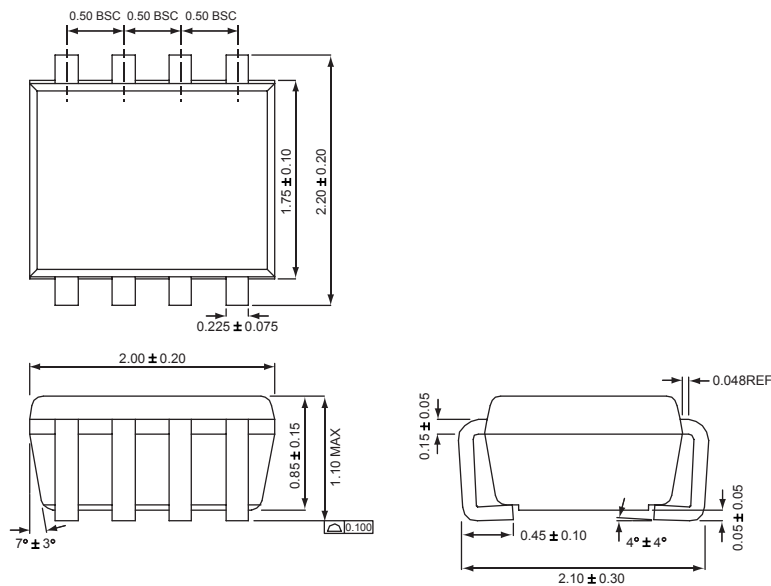

All dimensions in millimeters

AnalogicTech cannot assume responsibility for use of any circuitry other than circuitry entirely embodied in an AnalogicTech product. No circuit patent licenses, copyrights, mask work rights, or other intellectual property rights are implied.

AnalogicTech reserves the right to make changes to their products or specifications or to discontinue any product or service without notice, and advise customers to obtain the latest version of relevant information to verify, before placing orders, that information being relied on is current and complete. All products are sold subject to the terms and conditions of sale supplied at the time of order acknowledgement, including those pertaining to warranty, patent infringement, and limitation of liability.

AnalogicTech warrants performance of its semiconductor products to the specifications applicable at the time of sale in accordance with AnalogicTech's standard warranty. Testing and other quality control techniques are utilized to the extent AnalogicTech deems necessary to support this warranty. Specific testing of all parameters of each device is not necessarily performed.

Advanced Analogic Technologies, Inc.
830 E. Arques Avenue, Sunnyvale, CA 94085
Phone (408) 737-4600
Fax (408) 737-4611