

General Description

The AAT2803 is a dual charge pump designed to support both white LED backlight and flash applications for systems operating with lithium-ion/polymer batteries. The backlight charge pump is capable of driving up to six LEDs at a total of 180mA. The current sinks may be operated in group or in parallel for driving higher current LEDs. To maximize power efficiency, the charge pump operates in 1X, 1.5X, or 2X mode, where the mode of operation is automatically selected by comparing the forward voltage of each LED with the input voltage. AnalogicTech's AS²Cwire™ (Advanced Simple Serial Control™) serial digital input is used to enable, disable, and set current for each LED with a 16-level logarithmic scale plus four low-current settings down to 50µA for optimized efficiency, with a low housekeeping current of only 50µA.

The flash charge pump is a charge pump doubler with a regulated output voltage. It is designed to deliver 120mA of continuous current and up to 300mA of pulsed current. It has an independent enable pin for improved power savings.

The AAT2803 is equipped with built-in protection, short-circuit, and auto-disable for load short-circuit condition. Built-in soft-start circuitry prevents excessive inrush current during start-up. A low-current shutdown feature disconnects the load from V_{IN} and reduces quiescent current to less than 1µA.

The AAT2803 is available in a Pb-free, space-saving, thermally enhanced 24-pin 4x4mm QFN package and is rated over the -40°C to +85°C temperature range.

Typical Application

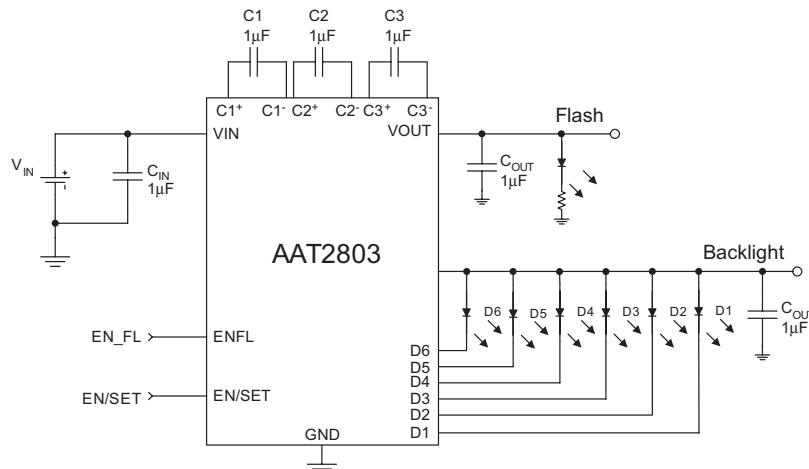

Features

- V_{IN} Range: 2.7V to 5.5V
- Dual Charge Pump:
 - Flash: Charge Pump Doubler
 - Backlight: Tri-Mode Charge Pump
- Backlight Charge Pump:
 - Programmable Current With Single GPIO
 - 16 Current Steps
 - 15/20/30mA Max Current
 - Four Low Current Settings
 - Individual Main/Sub-Group Control
 - Low I_Q (50µA) for Low-Current Mode
 - Drives Six Channels of LEDs
- Flash Charge Pump:
 - Regulated V_{OUT_FL} 4.5/5.0 Volts
 - Up to 300mA of Current for Flash
- 1MHz Constant Switching Frequency
- Independent Backlight/Flash Control
- Built-In Thermal Protection
- Built-In Auto-Disable for Open Circuit
- Automatic Soft Start
- $I_Q < 1\mu A$ in Shutdown
- Available in QFN44-24 Package

Applications

- Color (RGB) Lighting
- Programmable Current Sink
- White LED Backlighting
- White Photo Flash for Digital Still Cameras

Pin Descriptions

Pin #	Symbol	Function
1	C1-	Flying capacitor 1 negative terminal.
2	C1+	Flying capacitor 1 positive terminal. Connect a 1μF capacitor between C1+ and C1-.
3	VOUT_FL	Flash output voltage. Requires 1μF capacitor connected between this pin and ground.
4, 14	VIN	Input power supply. Requires 1μF capacitor connected between this pin and ground.
5	EN_FL	Enable pin for flash charge pump. For normal operation, connect to V _{IN} . When connected low, the flash charge pump shuts down and consumes less than 1μA of current.
6, 7, 23	N/C	No connect.
8	VOUT_BL	Backlight output voltage charge pump. Requires 1μF capacitor connected between this pin and ground.
9	C2+	Flying capacitor 2 positive terminal. Connect a 1μF capacitor between C2+ and C2-.
10	C3+	Flying capacitor 3 positive terminal. Connect a 1μF capacitor between C3+ and C3-.
11	C3-	Flying capacitor 3 negative terminal.
12	C2-	Flying capacitor 2 negative terminal.
13, 15, 24	GND	Ground.
16	D1	Current sink input #1.
17	D2	Current sink input #2.
18	D3	Current sink input #3.
19	D5	Current sink input #5.
20	D4	Current sink input #4.
21	D6	Current sink input #6.
22	EN/SET	AS ² Cwire serial interface control pin for backlight charge pump. It controls the current settings for all six channels. This pin should not be left floating.
EP		Exposed paddle (bottom); connect to GND directly beneath package.

Pin Configuration

**QFN44-24
(Top View)**

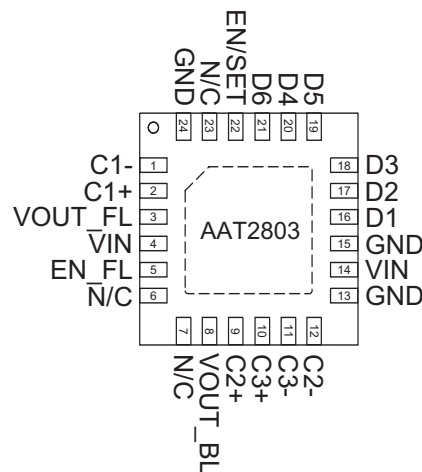

Absolute Maximum Ratings¹

Symbol	Description	Value	Units
V_{IN}	Input Voltage	-0.3 to 6	V
$V_{EN/SET}$	EN/SET to GND Voltage	-0.3 to $V_{IN} + 0.3$	V
T_J	Operating Junction Temperature Range	-40 to 150	°C
T_{LEAD}	Maximum Soldering Temperature (at leads, 10 sec)	300	°C

Thermal Information²

Symbol	Description	Value	Units
P_D	Maximum Power Dissipation ³	2.0	W
θ_{JA}	Maximum Thermal Resistance	50	°C/W

1. Stresses above those listed in Absolute Maximum Ratings may cause permanent damage to the device. Functional operation at conditions other than the operating conditions specified is not implied. Only one Absolute Maximum Rating should be applied at any one time.
2. Mounted on an FR4 board.
3. Derate 6.25mW/°C above 25°C.

Electrical Characteristics¹

$V_{IN} = 3.6V$, $C_{IN} = C_{OUT} = C_1 = C_2 = C_3 = 1.0\mu F$; $T_A = -40^\circ C$ to $+85^\circ C$, unless otherwise noted.
Typical values are $T_A = 25^\circ C$.

Symbol	Description	Conditions	Min	Typ	Max	Units
V_{IN}	Operation Range		2.7		5.5	V
I_{CC}	Operating Current	1X Mode, $3.0 \leq V_{IN} \leq 5.5$, Active, No Load Current; EN/SET = V_{IN} ; EN_FL = GND		0.3	1	mA
		1.5X Mode, $3.0 \leq V_{IN} \leq 5.5$, Active, No Load Current; EN/SET = V_{IN} ; EN_FL = GND		1.0	3.0	
		2X Mode, $3.0 \leq V_{IN} \leq 5.5$, Active, No Load Current; EN/SET = V_{IN} ; EN_FL = GND		2.0	3.7	
		$V_{OUT_FLASH} = 5V$; EN/SET = GND; EN_FL = V_{IN}		2.0	4.5	
		50 μA Setting, 1X Mode; EN/SET = V_{IN} ; EN_FL = GND		50		μA
I_{SHDN}	Shutdown Current	EN/SET = 0			1.0	μA
I_{DX}	I_{SINK} Average Current Accuracy ²	$I_{SET} = 30mA$, $T_A = 25^\circ C$	27	30	33	mA
		$I_{SET} = 4.1mA$, $T_A = 25^\circ C$	3.69	4.1	4.51	
$I_{(D-Match)}$	Current Matching Between Any Two Current Sink Inputs ^{3,4}	$V_F:D1:D4 = 3.6V$		0.5		%
V_{TH}	1X to 1.5X or 1.5X to 2X Transition Threshold at Any D_X Pin			150		mV
V_{OUT}	Output Voltage (Flash Charge Pump) ⁵	$3.0 < V_{IN} < 5V$, $I_{OUT} = 120mA$; EN_FL = V_{IN}	4.3	4.5	4.7	V
I_{OUT}	Max Continuous Output Current (Flash Charge Pump) ⁵	$V_{IN} = 3.3V$; $V_{OUT} = 4.5V$; EN_FL = V_{IN}	120			mA
	Max Pulsed Output Current ⁵	$V_{IN} = 3.6V$; $V_{OUT} = 4.5V$; $I_{PULSED} = 250ms$		300		
T_{SS}	Soft-Start Time	Backlight Charge Pump		100		μs
		Flash Charge Pump		200		
F_{CLK}	Clock Frequency			1.0		MHz
$V_{EN(L)}$	Enable Threshold Low	$V_{IN} = 2.7V$			0.4	V
$V_{EN(H)}$	Enable Threshold High	$V_{IN} = 5.5V$	1.4			V

1. The AAT2803 is guaranteed to meet performance specifications over the $-40^\circ C$ to $+85^\circ C$ operating temperature range and is assured by design, characterization, and correlation with statistical process controls.
2. Determined by the average of all active channels.
3. Current matching is defined as the deviation of any sink current from the average of all active channels.
4. Specification applies only to the tri-mode charge pump.
5. Specification applies only to the charge pump doubler.

Electrical Characteristics¹

$V_{IN} = 3.6V$, $C_{IN} = C_{OUT} = C_1 = C_2 = C_3 = 1.0\mu F$; $T_A = -40^\circ C$ to $+85^\circ C$, unless otherwise noted.
 Typical values are $T_A = 25^\circ C$.

Symbol	Description	Conditions	Min	Typ	Max	Units
$T_{EN/SET\ LO}$	EN/SET Low Time		0.3		75	μs
T_{EN/SET_HL_MIN}	Minimum EN/SET High Time			50		ns
T_{EN/SET_HL_MAX}	Maximum EN/SET High Time				75	μs
T_{OFF}	EN/SET Off Timeout				500	μs
T_{LAT}	EN/SET Latch Timeout				500	μs
$I_{EN/SET;EN_FL}$	Input Leakage	$V_{EN/SET;EN_FL} = 5V$; $V_{IN} = 5V$	-1.0		1.0	μA

1. The AAT2803 is guaranteed to meet performance specifications over the $-40^\circ C$ to $+85^\circ C$ operating temperature range and is assured by design, characterization, and correlation with statistical process controls.

Typical Characteristics—Flash Driver Charge Pump Section

Output Voltage vs. Output Current
($V_{OUT_FL} = 4.5V$; $EN_FL = V_{IN}$; $EN/SET = GND$)

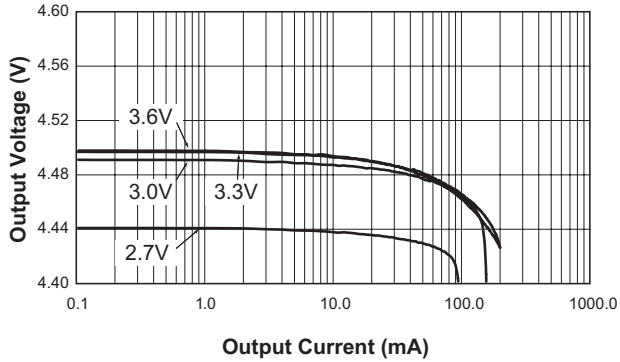

Maximum Current Pulse vs. Supply Voltage
($V_{OUT_FL} = 4.5V$; $EN_FL = V_{IN}$; $EN/SET = GND$)

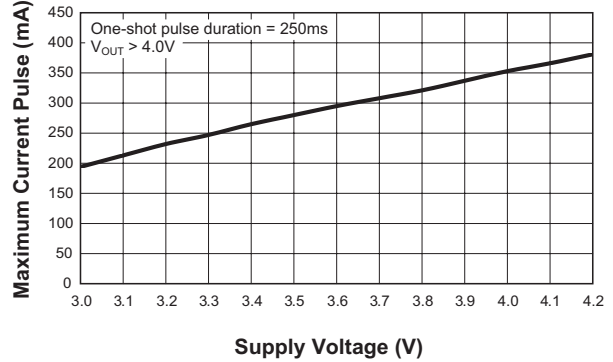

Start-Up Time
(50mA Load)

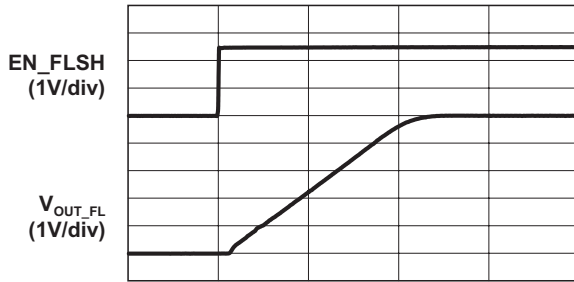

100µs/div

Start-Up Time
(100mA Load)

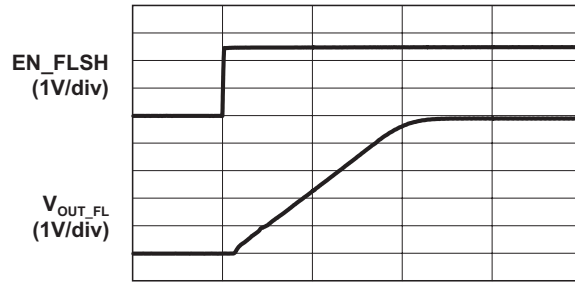

100µs/div

Load Response vs. Time
(50mA Load)

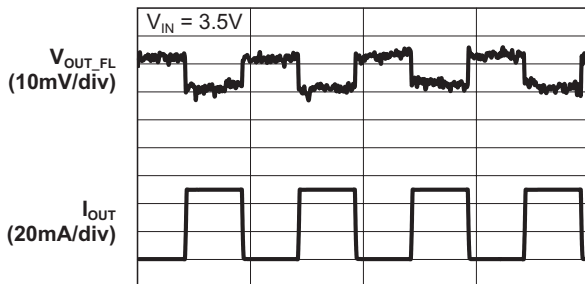

5ms/div

Load Response vs. Time
(100mA Load)

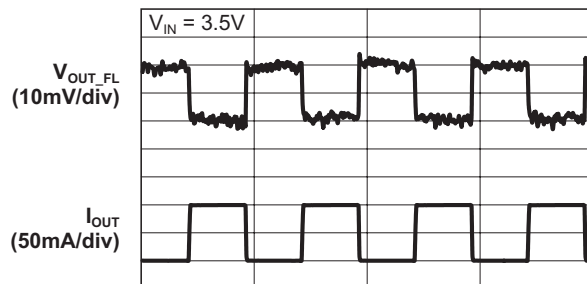

5ms/div

Typical Characteristics–Flash Driver Charge Pump Section

Output Ripple Voltage vs. Time
($I_{OUT} = 50\text{mA}$ @ $V_{IN} = 3.5\text{V}$)

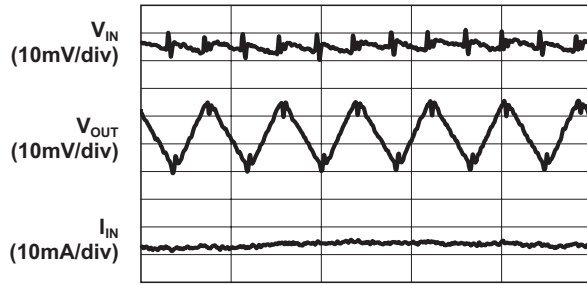

500ns/div

Output Ripple Voltage vs. Time
($I_{OUT} = 100\text{mA}$ @ $V_{IN} = 3.5\text{V}$)

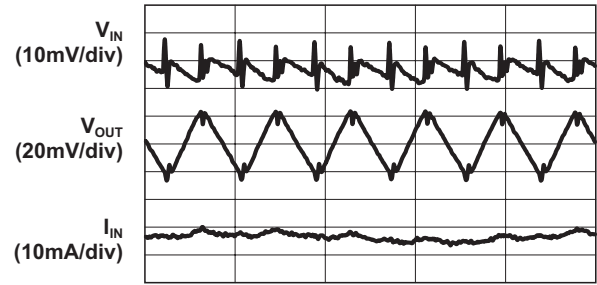

500ns/div

Supply Current vs. Supply Voltage

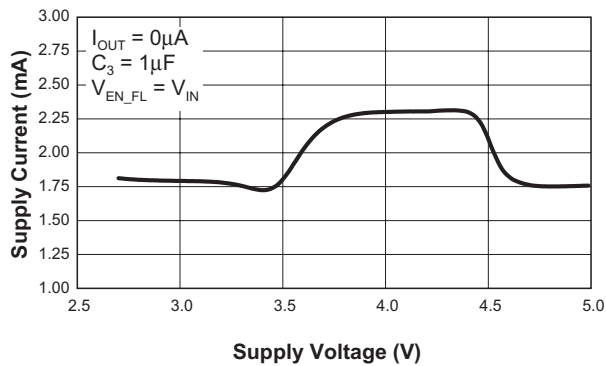

Oscillator Frequency vs. Supply Voltage

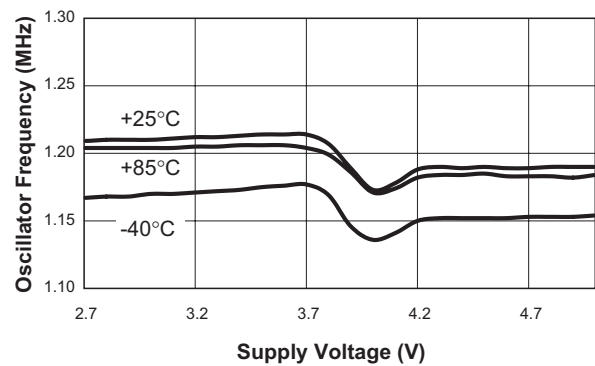

Typical Characteristics—White LED Backlight Driver Section

Unless otherwise noted, $V_{IN} = 3.6V$, $C_{IN} = C_{OUT} = C_1 = C_2 = C_3 = 1.0\mu F$; $T_A = 25^\circ C$.

Efficiency vs. Supply Voltage

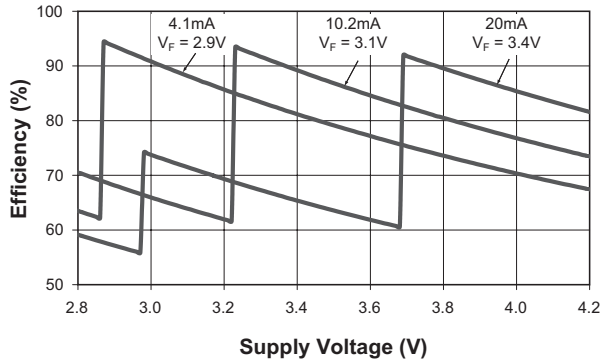

Turn-On to 1X Mode
($V_{IN} = 4.2V$; 20mA Load)

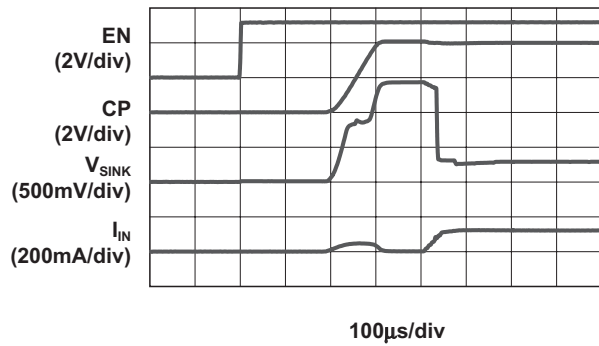

Turn-On to 1.5X Mode
($V_{IN} = 3.8V$; 20mA Load)

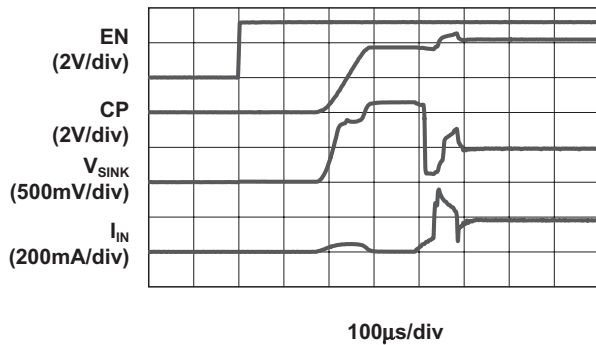

Turn-On to 2X Mode
($V_{IN} = 2.8V$; 20mA Load)

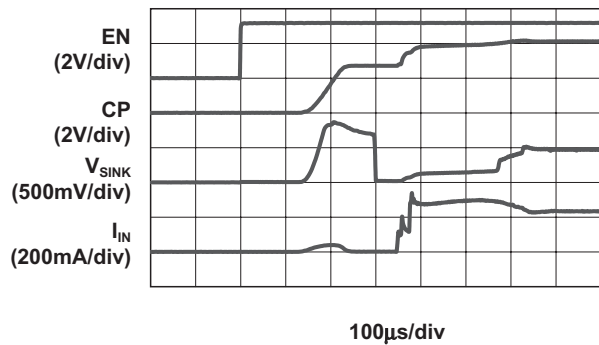

Turn-Off from 1.5X Mode
($V_{IN} = 3.5V$; 20mA Load)

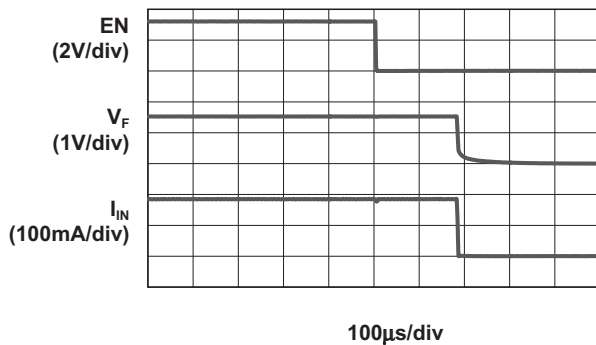

Current Matching vs. Temperature

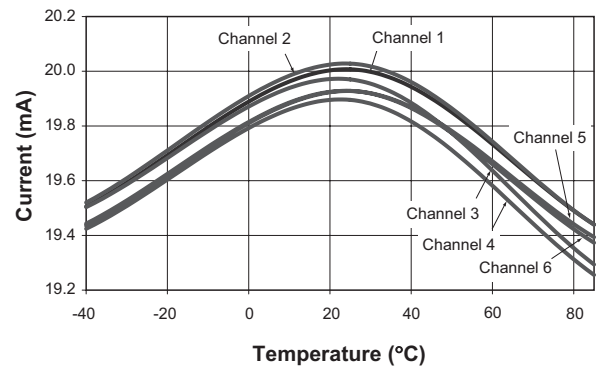

Typical Characteristics—White LED Backlight Driver Section

Unless otherwise noted, $V_{IN} = 3.6V$, $C_{IN} = C_{OUT} = C_1 = C_2 = C_3 = 1.0\mu F$; $T_A = 25^\circ C$.

Load Characteristics
($V_{IN} = 3.8V$; 1.5X Mode; 15mA Load)

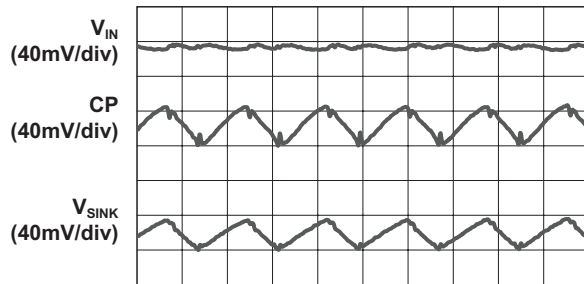

500ns/div

Load Characteristics
($V_{IN} = 2.9V$; 2X Mode; 15mA Load)

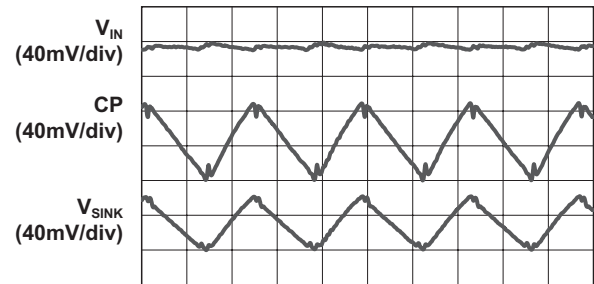

500ns/div

Load Characteristics
($V_{IN} = 4.0V$; 1.5X Mode; 20mA Load)

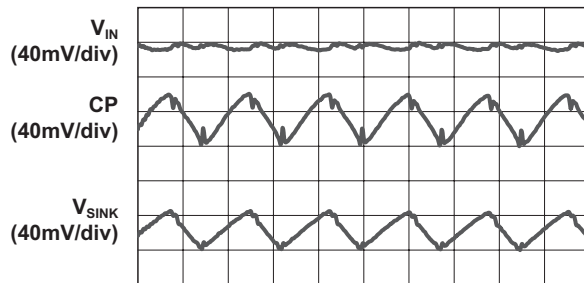

500ns/div

Load Characteristics
($V_{IN} = 3.1V$; 2X Mode; 20mA Load)

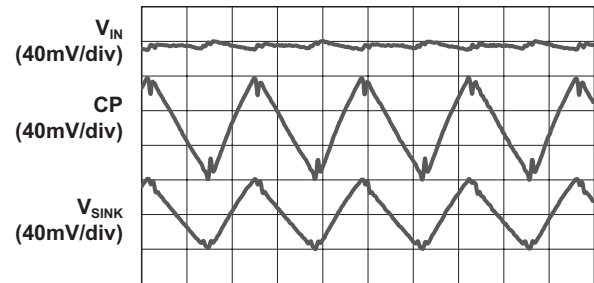

500ns/div

Load Characteristics
($V_{IN} = 4.3V$; 1.5X Mode; 30mA Load)

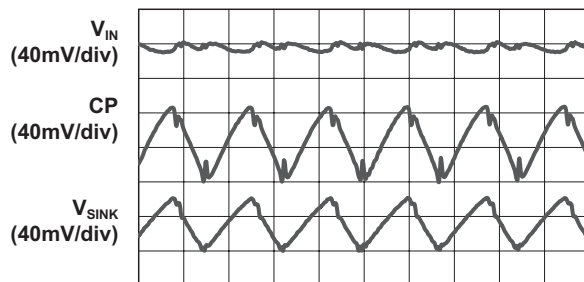

500ns/div

Load Characteristics
($V_{IN} = 3.6V$; 2X Mode; 30mA Load)

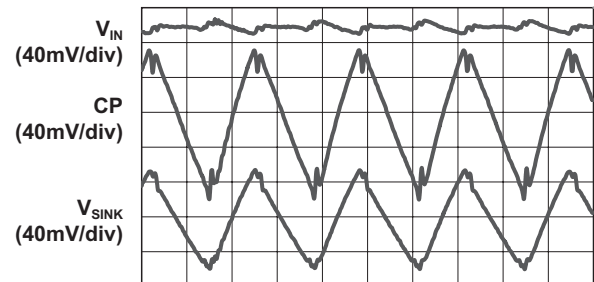

500ns/div

Typical Characteristics—White LED Backlight Driver Section

Unless otherwise noted, $V_{IN} = 3.6V$, $C_{IN} = C_{OUT} = C_1 = C_2 = C_3 = 1.0\mu F$; $T_A = 25^\circ C$.

T_{LAT} vs. V_{IN}

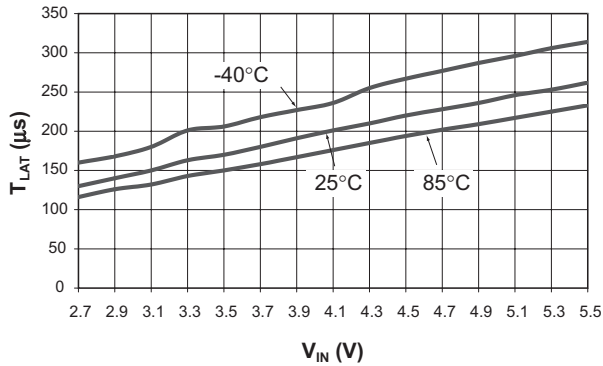

T_{OFF} vs. V_{IN}

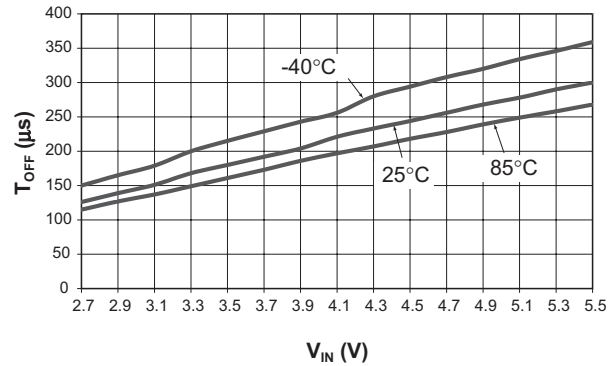

Input Ripple vs. V_{IN}

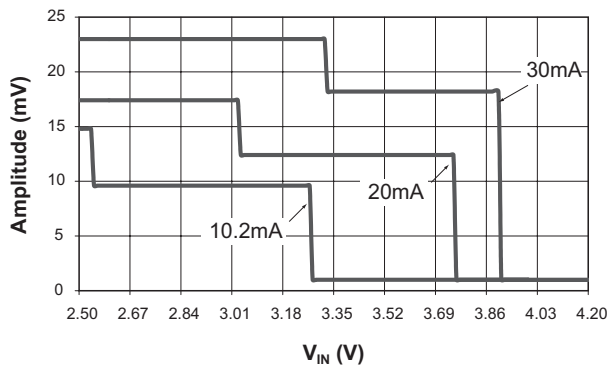

V_{IH} vs. V_{IN}

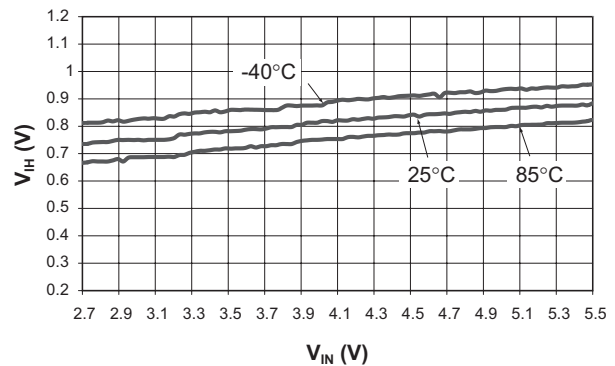

V_{IL} vs. V_{IN}

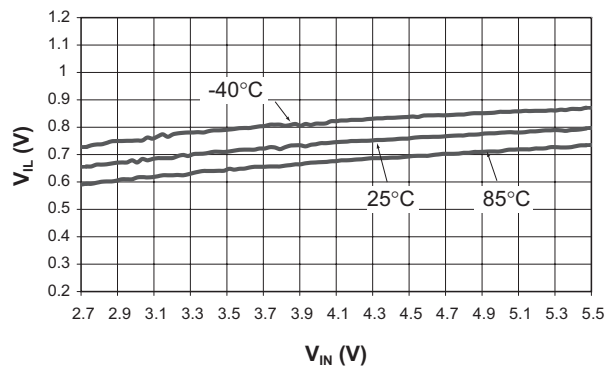

Functional Block Diagram

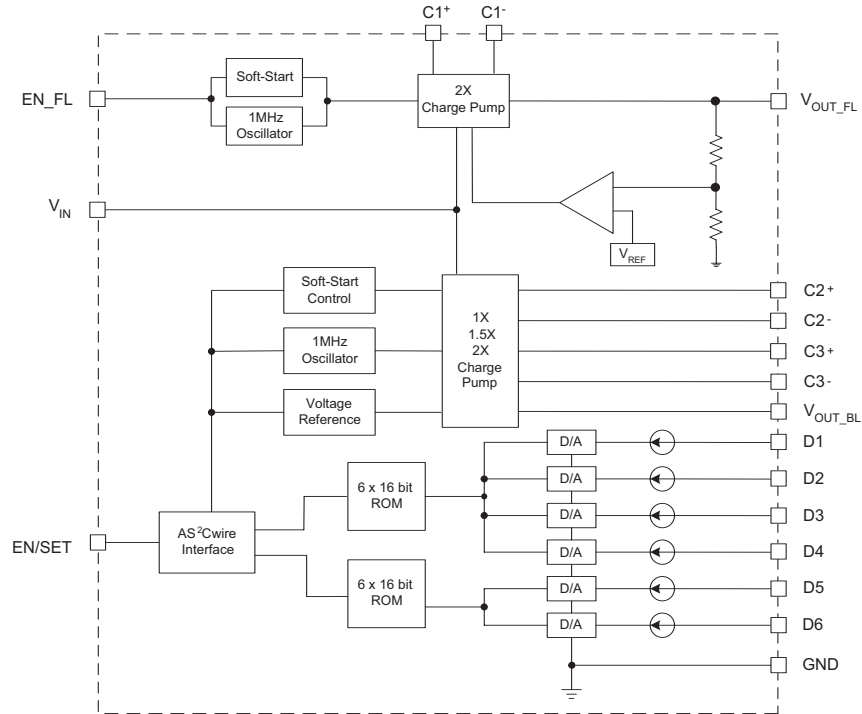

Functional Description

The AAT2803 is a dual charge pump targeted for backlight and flash applications. The charge pump for white LED applications is a tri-mode load switch (1X) and high efficiency (1.5X or 2X) charge pump device. To maximize power conversion efficiency, an internal sensing circuit monitors the voltage required on each constant current sink input and sets the load switch and charge pump modes based on the input battery voltage and the current sink input voltage. As the battery discharges over time, the backlight charge pump is enabled when any of the six current sink inputs near dropout. The charge pump initially starts in 1.5X mode. If the charge pump output drops enough for any current source output to become close to dropout, the charge pump will automatically transition to 2X mode.

For flash applications, charge pump doubler architecture is used to support the high current demand required by the application. Charge pump regulation is achieved by sensing the output voltage

through an internal resistor divider network. A switch doubling circuit is enabled when the divided output drops below a preset trip point controlled by an internal comparator. The free-running charge pump switching frequency is approximately 1MHz. The charge pump is designed to deliver 120mA of continuous current and 300mA of pulsed current.

The AAT2803 requires only six external components: three 1 μ F ceramic capacitors for the charge pump flying capacitors (C_1 , C_2 , and C_3), one 1 μ F ceramic input capacitor (C_{IN}), one 0.33 μ F to 1 μ F ceramic capacitor for the backlight charge pump output, and one 1 μ F for the flash charge pump output. The six constant current sink inputs (D1 to D6) can drive six individual LEDs with a maximum current of 30mA each. The unused sink inputs must be connected to V_{OUT_BL} , otherwise the part will operate only in 2X charge pump mode. The AS²Cwire serial interface enables the backlight charge pump and sets the current sink magnitudes. AS²Cwire addressing allows independent control of two groups of current sink input: D1 to D4 and D5 to D6.

Constant Current Output Level Settings

The constant current sink levels for the white LED backlight (D1 to D6) are set via the serial interface according to a logarithmic scale where each code is 1dB lower than the previous code. In this manner, LED brightness appears linear with each increasing code count. Because the inputs D1 to D6 are true independent constant current sinks, the voltage observed on any single given input will be determined by the actual forward voltage (V_F) for the LED being driven.

Since the input current sinks are programmable, no PWM (pulse width modulation) or additional control circuitry is needed to control LED brightness. This feature greatly reduces the burden on a microcontroller or system IC to manage LED or display brightness, allowing the user to "set it and forget it." With its high-speed serial interface (1MHz data rate), the input sink current can be changed successively to brighten or dim LEDs in smooth transitions (e.g., to fade-out) or in abrupt steps, giving the user complete programmability and real-time control of LED brightness.

The 16 individual current level settings are each approximately 1dB apart (see Current Level Settings table). Code 1 is full scale, Code 15 is full scale attenuated by 14dB, and Code 16 is reserved as a "no current" setting.

Data	30mA Max I_{OUT} (mA)	20mA Max I_{OUT} (mA)	15mA Max I_{OUT} (mA)
1	30.0	20.0	15.0
2	26.7	17.8	13.3
3	23.8	15.9	11.9
4	21.4	14.3	10.7
5	19.0	12.7	9.5
6	16.7	11.1	8.3
7	15.2	10.2	7.6
8	13.3	8.9	6.7
9	11.9	7.9	6.0
10	10.5	7.0	5.2
11	9.5	6.3	4.8
12	8.6	5.7	4.3
13	7.6	5.1	3.8
14	6.7	4.4	3.3
15	6.2	4.1	3.1
16	0.0	0.0	0.0

Table 1: Current Level Settings.

AS²Cwire Serial Interface

The Advanced Simple Serial Control (AS²Cwire) single wire interface is used to set the possible combinations of current levels and LED channel states. AS²Cwire has addressing capability for multiple data registers. With multiple data registers, the backlight charge pump main and sub-channels can be programmed together or independently from one another.

AS²Cwire relies on the number of rising edges of the EN/SET pin to address and load the registers. AS²Cwire latches data or address after the EN/SET pin has been held high for time T_{LAT} . Address or data is differentiated by the number of EN/SET rising edges. Since the data registers are 4 bits each, the differentiating number of pulses is 2^4 or 16, so that Address 1 is signified by 17 rising edges, Address 2 by 18 rising edges, and so forth. Data is set to any number of rising edges between 1 and including 16. A typical write protocol is a burst of EN/SET rising edges, signifying a particular Address, followed by a pause with EN/SET held high for the T_{LAT} timeout period, a burst of rising edges signifying Data, and a T_{LAT} timeout for the data registers. Once an address is set, then multiple writes to the corresponding data register are allowed.

When EN/SET is held low for an amount of time greater than T_{OFF} , the backlight charge pump enters into shutdown mode and draws less than $1\mu A$ from the supply. Address 1 is the default address on the first rising edge after the backlight charge pump has been disabled. Whenever shutdown mode is entered, all registers are reset to 1.

AS²Cwire Serial Interface Timing

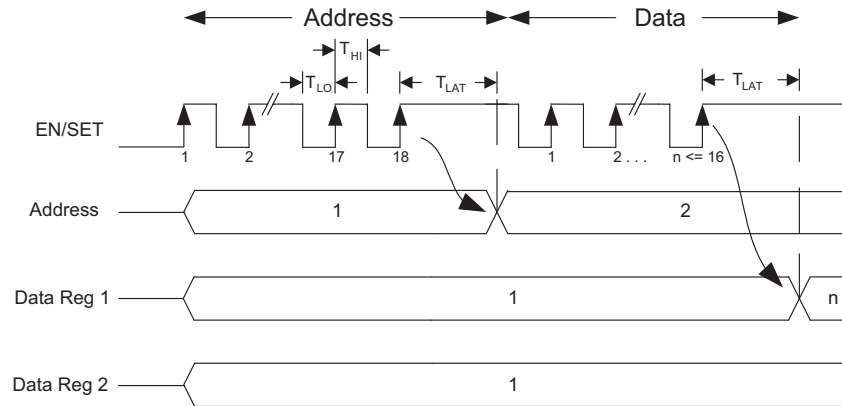

AS²Cwire Addressing

Five addresses are available to enable all of the part's functionality. Two 4-bit registers control the main and sub-channels, giving 16 settings for each. The main and sub-channels are programmed to the same constant current level by using Address 1. Use Addresses 2 and 3 to program the main and sub-channels independently. Use Address 4 to program the Max Current register, which sets the Max Current scale. Lastly, Address 5 programs the Low Current register. The Low Current register controls the efficient Low Current mode. When the Max Current register is programmed to 1, 2, or 3, changing the data for Addresses 1-3 will result in the corresponding values found in the Constant Current Programming Levels table.

When the Max Current register is programmed to 4, the part is programmed to operate in Low Current mode and the Data for Addresses 1-3 is irrelevant. In Low Current mode, the Low Current register takes precedence. See the Low Current Register Settings table below for the current level settings and main/sub-configurations that result.

Address	EN/SET Edges	Addressed Register
1	17	1&2: D1-D6 Current
2	18	1: D1-D4 Current
3	19	2: D5-D6 Current
4	20	3: Max Current
5	21	4: Low Current

Max Current and Low Current Registers

Use the Max Current and Low Current registers to program constant current settings outside of the 20mA Max scale. By default (without changing the Max Current register), the backlight charge pump operates in the 20mA Max scale (see Constant Current Programming Levels). For example, to change to the 30mA Max scale, address the Max Current register with 20 rising edges and pause for T_{LAT} . Program the Max Current register with 2 rising edges and pause for T_{LAT} . The part will next operate in the same Data row, but for the setting found in the 30mA Max column. Next, to change to a different setting on the 30mA Max scale, address the D1-D6 register with 17 rising edges. Program the new constant current level with 1-16 rising edges. The part will update to the new Data setting according to the Constant Current Programming Levels table.

The backlight charge pump has a distinct Low Current mode with ultra-low quiescent current. For drive currents of 2mA or less, the part operates with significantly reduced quiescent current. This is particularly useful for applications requiring an "always on" condition such as transmissive displays. As an example, to change to Low Current mode, address the Max Current register with 20 rising edges and pause for T_{LAT} . Program the Max Current register with 4 rising edges and pause for T_{LAT} . Address the Low Current register with 21 rising edges and pause for T_{LAT} . Program the Low Current register with 1-16 rising edges. The part will update to the new Low Current mode setting and operate with significantly reduced quiescent current.

Max Current Register Settings—Address 4

Data	Max Current
1	20mA Max Scale
2	30mA Max Scale
3	15mA Max Scale
4	Low Current Mode

Low Current Register Settings—Address 5

Data	D1-D4 (mA)	D5-D6 (mA)
1	0	0
2	0	0
3	0	0
4	0	0
5	0	0.05
6	0	0.5
7	0	1
8	0	2
9	0.05	0
10	0.5	0
11	1	0
12	2	0
13	0.05	0.05
14	0.5	0.5
15	1	1
16	2	2

Disabled Current Sinks

The backlight charge pump is equipped with an auto-disable feature to protect against an LED failure condition. Current sink inputs that are not used should be disabled. To disable and properly terminate unused current sink inputs, they must be tied to V_{OUT} . If left unconnected or terminated to ground, the part will be forced to operate in 2X charge pump mode.

Properly terminating unused current sink inputs is important to prevent the charge pump modes from activating prematurely. When properly terminated, only a small sense current flows for each disabled channel. The sense current for each disabled channel is less than 120 μ A.

Applications Information

LED Selection

Although the AAT2803 is specifically intended for driving white LEDs, the device can also be used to drive most types of LEDs with forward voltage specifications ranging from 2.0V to 4.7V. LED applications may include main and sub-LCD display backlighting, camera photo-flash applications, color (RGB) LEDs, infrared (IR) diodes for remotes, and other loads benefiting from a controlled output current generated from a varying input voltage.

In some instances (e.g., in high-luminous-output applications such as photo flash), it may be necessary to drive high- V_F type LEDs. The low-dropout current sinks in the AAT2803 make it capable of driving LEDs with forward voltages as high as 4.7V at full current from an input supply as low as 3.0V. Outputs can be paralleled to drive high-current LEDs without complication.

Device Switching Noise Performance

The AAT2803 operates at a fixed frequency of approximately 1MHz to control noise and limit harmonics that can interfere with the RF operation of cellular telephone handsets or other communication devices. Back-injected noise appearing on the input pin of the charge pump is 20mV peak-to-peak, typically ten times less than inductor-based DC/DC boost converter white LED backlight solutions. The AAT2803 soft-start feature prevents noise transient effects associated with inrush currents during start-up of the charge pump circuit.

Capacitor Selection

Careful selection of the six external capacitors C_{IN} , C_1 , C_2 , C_3 , and C_{OUT} (for backlight and flash) is important because they will affect turn-on time, output ripple, and transient performance. Optimum performance will be obtained when low equivalent series resistance (ESR) ceramic capacitors are used. In general, low ESR may be defined as less than 100m Ω . A value of 1 μ F for all four capacitors is a good starting point when choosing capacitors. If the LED current sources are only programmed for light current levels, then the capacitor size may be decreased.

Capacitor Characteristics

Ceramic composition capacitors are highly recommended over all other types of capacitors for use with the AAT2803. Ceramic capacitors offer many advantages over their tantalum and aluminum electrolytic counterparts. A ceramic capacitor typically has very low ESR, is lowest cost, has a smaller PCB footprint, and is non-polarized. Low ESR ceramic capacitors help maximize charge pump transient response. Since ceramic capacitors are non-polarized, they are not prone to incorrect connection damage.

Equivalent Series Resistance

ESR is an important characteristic to consider when selecting a capacitor. ESR is a resistance internal to a capacitor that is caused by the leads, internal connections, size or area, material composition, and ambient temperature. Capacitor ESR is typically measured in milliohms for ceramic capacitors and can range to more than several ohms for tantalum or aluminum electrolytic capacitors.

Ceramic Capacitor Materials

Ceramic capacitors less than 0.1 μ F are typically made from NPO or C0G materials. NPO and C0G materials typically have tight tolerance and are stable over temperature. Larger capacitor values are typically composed of X7R, X5R, Z5U, or Y5V dielectric materials. Large ceramic capacitors, typically greater than 2.2 μ F, are often available in low-cost Y5V and Z5U dielectrics, but capacitors greater than 1 μ F are not typically required.

Capacitor area is another contributor to ESR. Capacitors that are physically large will have a lower ESR when compared to an equivalent material smaller capacitor. These larger devices can improve circuit transient response when compared to an equal value capacitor in a smaller package size.

Ordering Information

Package	Marking ¹	Part Number (Tape and Reel) ²
QFN44-24	OFXYY	AAT2803ISK-4.5-T1



All AnalogicTech products are offered in Pb-free packaging. The term “Pb-free” means semiconductor products that are in compliance with current RoHS standards, including the requirement that lead not exceed 0.1% by weight in homogeneous materials. For more information, please visit our website at <http://www.analogictech.com/pbfree>.

Package Information

QFN44-24

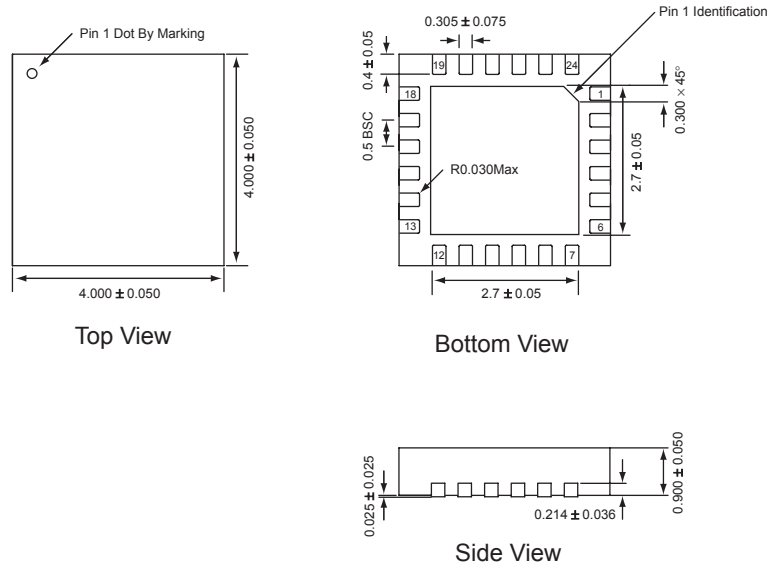

Package dimensions subject to change.
All dimensions in millimeters.

1. XYY = assembly and date code.
2. Sample stock is generally held on part numbers listed in **BOLD**.

© Advanced Analogic Technologies, Inc.

AnalogicTech cannot assume responsibility for use of any circuitry other than circuitry entirely embodied in an AnalogicTech product. No circuit patent licenses, copyrights, mask work rights, or other intellectual property rights are implied. AnalogicTech reserves the right to make changes to their products or specifications or to discontinue any product or service without notice. Customers are advised to obtain the latest version of relevant information to verify, before placing orders, that information being relied on is current and complete. All products are sold subject to the terms and conditions of sale supplied at the time of order acknowledgement, including those pertaining to warranty, patent infringement, and limitation of liability. AnalogicTech warrants performance of its semiconductor products to the specifications applicable at the time of sale in accordance with AnalogicTech's standard warranty. Testing and other quality control techniques are utilized to the extent AnalogicTech deems necessary to support this warranty. Specific testing of all parameters of each device is not necessarily performed.

Advanced Analogic Technologies, Inc.
830 E. Arques Avenue, Sunnyvale, CA 94085
Phone (408) 737-4600
Fax (408) 737-4611