

### General Description

The AAT2801 is a member of AnalogicTech's Total Power Management IC™ (TPMIC™) product family. It has a dual charge pump architecture designed to support both the white LED backlight and flash applications for systems operating with Lithium-Ion batteries. The backlight charge pump provides power required to drive up to four LEDs. To maximize power efficiency, it automatically selects 1X, 1.5X, or 2X mode. The device produces current levels up to 30mA on each of its four current source outputs. AnalogicTech's Simple Serial Control™ (S<sup>2</sup>Cwire™) interface is used to enable, disable, and set the LED drive current with a 32-level logarithmic scale LED brightness control.

The flash charge pump is a charge pump doubler with a regulated output voltage. It is designed to deliver 120mA of continuous current and up to 250mA of pulsed current. It has an independent enable pin for improved power savings.

The AAT2801 is equipped with AnalogicTech's AutoBias™ technology which allows individual LEDs to be powered either by charge pump or battery input, determined internally and automatically to maximize the power efficiency even with a large difference in LED forward voltage.

The AAT2801 has thermal protection and built-in soft-start circuitry. A high charge pump switching frequency enables the use of very small external capacitors. The AAT2801 is available in the 16-pin TDFN44 package.

### Features

- $V_{IN}$  Range: 2.7V to 5.5V
- Dual Charge Pump
  - Flash: Charge Pump Doubler
  - Backlight: Tri-Mode Charge Pump
- Drives Low- $V_F$  and High- $V_F$  LEDs
- Up to Four 30mA Outputs
- 32-Position Logarithmic Scale with Digital Control
- Low Noise Constant Frequency Operation
- 1MHz Switching Frequency
- AutoBias Technology
- Regulated 4.5/5.0 Volts  $V_{OUT\_FLASH}$
- Up to 250mA of Current for Flash
- Automatic Soft Start
- No Inductors
- $I_Q < 1\mu A$  in Shutdown
- Available in 16-pin TDFN44 Package

### Applications

- Display Modules
- Mobile Phones
- PDAs
- Smart Phones

### Typical Application

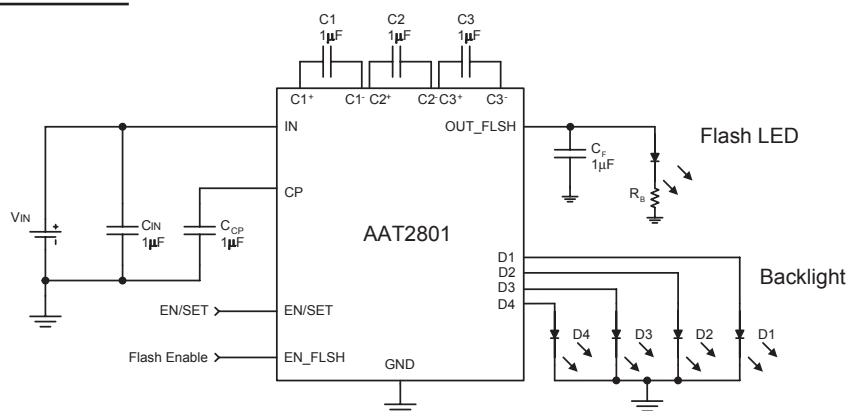

### Pin Descriptions

Pin #	Symbol	Function
1	C3-	Flying capacitor 3 negative terminal. Connect a 1μF capacitor between C3- and C3+.
2	C3+	Flying capacitor 3 positive terminal.
3	OUT_FLASH	Flash output voltage. Requires 1μF capacitor connected between this pin and ground.
4	IN	Input power supply. Requires 1μF capacitor connected between this pin and ground.
5	C1+	Flying capacitor 1 positive terminal. Connect a 1μF capacitor between C1+ and C1-.
6	C1-	Flying capacitor 1 negative terminal.
7	CP	White LED charge pump output. Requires 1μF capacitor connected between this pin and ground.
8	C2+	Flying capacitor 2 positive terminal. Connect a 1μF capacitor between C2+ and C3-.
9	C2-	Flying capacitor 2 negative terminal.
10	GND	Ground.
11	EN/SET	S <sup>2</sup> Cwire serial interface control pin for the white LED charge pump. This pin should not be left floating.
12	D3	Current source output #3.
13	D1	Current source output #1.
14	D4	Current source output #4.
15	D2	Current source output #2.
16	EN_FLSH	Active high enable pin for the flash charge pump. When connected low, the charge pump shuts down and consumes less than 1μA of current.
EP		Exposed paddle (bottom); connect to GND directly beneath package.

### Pin Configuration

**TDFN44-16  
(Top View)**

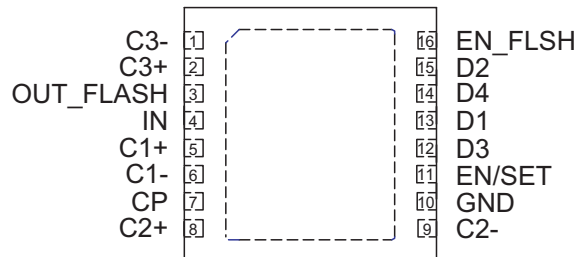

## Absolute Maximum Ratings<sup>1</sup>

Symbol	Description	Value	Units
$V_{IN}$	Input Voltage	-0.3 to 6.0	V
$V_{EN/SET}$	EN/SET to GND Voltage	-0.3 to $V_{IN}+0.3$	V
$I_{OUT}^2$	Maximum DC Output Current	120	mA
$T_J$	Operating Junction Temperature Range	-40 to 150	°C

## Thermal Information

Symbol	Description	Value	Units
$P_D$	Maximum Power Dissipation <sup>3, 4</sup>	2.0	mW
$\theta_{JA}$	Thermal Resistance <sup>3</sup>	50	°C/W

1. Stresses above those listed in Absolute Maximum Ratings may cause permanent damage to the device. Functional operation at conditions other than the operating conditions specified is not implied. Only one Absolute Maximum Rating should be applied at any one time.
2. Based on long-term current density limitation.
3. Mounted on an FR4 board.
4. Derate 6.25mW/°C above 25°C.

### Electrical Characteristics<sup>1</sup>

$C_{IN} = C_{CP} = C_F = C1 = C2 = C3 = 1.0\mu\text{F}$ ;  $T_A = -40^\circ\text{C}$  to  $85^\circ\text{C}$ , unless otherwise noted.

Symbol	Description	Conditions	Min	Typ	Max	Units
<b>Input Power Supply</b>						
$V_{IN}$	Operation Range		2.7		5.5	V
$I_{CC}$	Operating Current	$3.0 \leq V_{IN} \leq 5.5$ , No Load Current; $V_{OUT\_FLSH} = 5\text{V}$ , $EN/SET = \text{GND}$ , $EN\_FLSH = V_{IN}$	-	3.0	4.5	mA
		$3.0 \leq V_{IN} \leq 5.5$ , $EN/SET = V_{IN}$ , $EN\_FLSH = \text{GND}$ , $VD1:VD4 = 2.0\text{V}$ , $CP = 1\text{X}$		0.55		
		$3.0 \leq V_{IN} \leq 5.5$ , No Load Current; $EN/SET = V_{IN}$ , $EN\_FLSH = \text{GND}$ , $CP = 1.5\text{X}$	-	3.0	5.0	
$I_{SHDN}$	Shutdown Current	$EN\_FLSH = EN/SET = 0$	-		1.0	$\mu\text{A}$
$I_{DX}$	Output Current Accuracy <sup>2</sup>	$V_{IN} = 3.5$ , Code = 32, $T_A = 25^\circ\text{C}$	-10		10	%
$I_{(D-Match)}$	Current Matching <sup>3</sup>	$VD1:D4 = 3.6$ , $V_{IN} = 3.5\text{V}$ ; LED Charge Pump Only	-3.0	$\pm 0.5$	3.0	%
$V_{OUT}$	Flash Charge Pump Output Voltage	$3.0\text{V} < V_{IN} < 5\text{V}$ , $I_{OUT} = 120\text{mA}$ ; $EN\_FLSH = V_{IN}$	4.3	4.5	4.7	V
$I_{OUT}$	Maximum Continuous $I_{OUT}$	$V_{IN} = 3.6\text{V}$ ; $V_{OUT} = 4.5\text{V}$ ; $EN\_FLSH = V_{IN}$	120		-	mA
	Maximum Pulsed $I_{OUT}$	$V_{IN} = 3.6\text{V}$ ; $V_{OUT} = 4.5\text{V}$ ; $I_{Pulsed} < 500\text{mS}$	250		-	
$\eta_{CP}$	White LED Charge Pump Section Efficiency	$V_{IN} = 3.5\text{V}$ , $I_{OUT(TOTAL)} = 120\text{mA}$ , Measured from IN to CP		93		%
<b>Charge Pump Section</b>						
$T_{SS}$	Soft-Start Time	Backlight Charge Pump		50		$\mu\text{s}$
		Flash Charge Pump		200		
$F_{CLK}$	Clock Frequency			1.0		MHz
<b>EN/SET</b>						
$V_{EN(L)}$	Enable Threshold Low		-		0.4	V
$V_{EN(H)}$	Enable Threshold High		1.4		-	V
$T_{EN/SET LO}$	EN/SET Low Time	$V_{EN/SET} < 0.6\text{V}$	0.3		75	$\mu\text{s}$
$T_{EN/SET HI MIN}$	Minimum EN/SET High Time	$V_{EN/SET} > 1.4\text{V}$		50		$\mu\text{s}$
$T_{EN/SET HI MAX}$	Maximum EN/SET High Time	$V_{EN/SET} > 1.4\text{V}$	-		75	$\mu\text{s}$
$T_{OFF}$	EN/SET Off Timeout	$V_{EN/SET} < 0.6\text{V}$	-		500	$\mu\text{s}$
$T_{LAT}$	EN/SET Latch Timeout	$V_{EN/SET} > 1.4\text{V}$	-		500	$\mu\text{s}$
$I_{EN/SET/EN\_FLSH}$	Input Leakage	$V_{EN/SET/EN\_FLSH} = 5\text{V}$ , $V_{IN} = 5\text{V}$	-1.0		1.0	$\mu\text{A}$

- The AAT2801 is guaranteed to meet performance specifications over the  $-40^\circ\text{C}$  to  $85^\circ\text{C}$  operating temperature range and is assured by design, characterization, and correlation with statistical process controls.
- Codes 2 through 7 are guaranteed to be within  $\pm 15\%$  of stated current level.
- Current matching is defined as  $I_{(D-Match)} = (I_D - I_{AVE})/I_{AVE}$ .

### Typical Characteristics–White LED Backlight Driver Section

$V_{IN} = 3.5V$ ,  $C_{IN} = 2.2\mu F$ ,  $C_{CP} = C1 = C2 = 1.0\mu F$ ;  $T_A = 25^\circ C$ , unless otherwise noted.

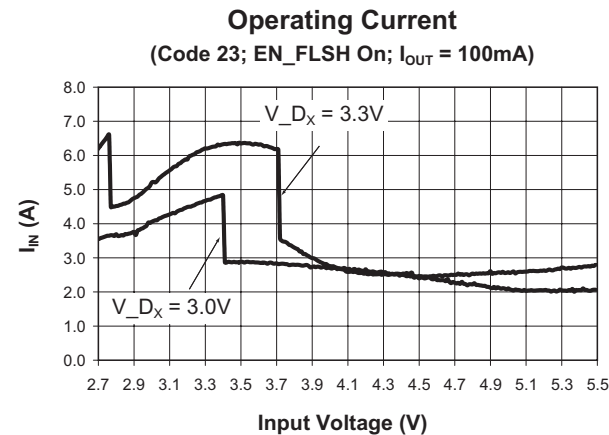
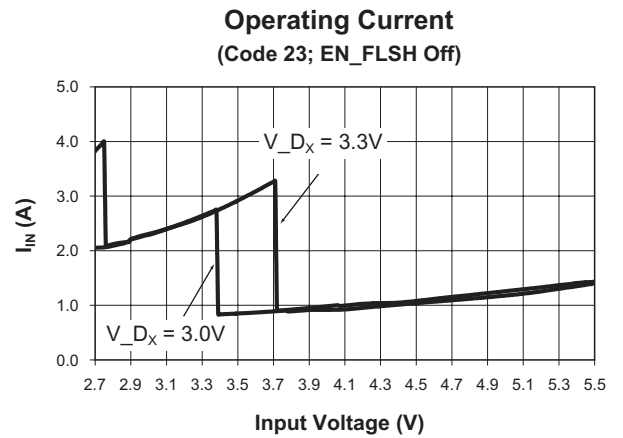
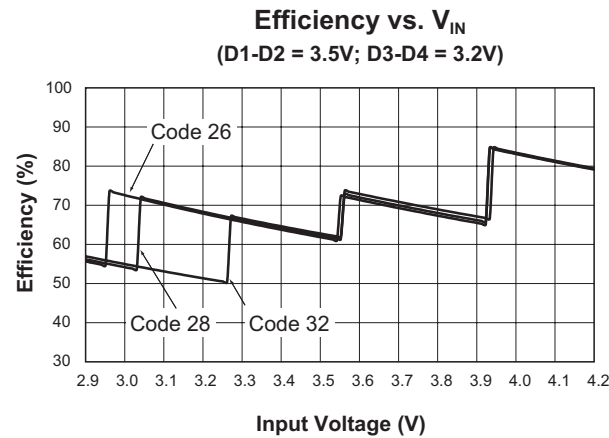
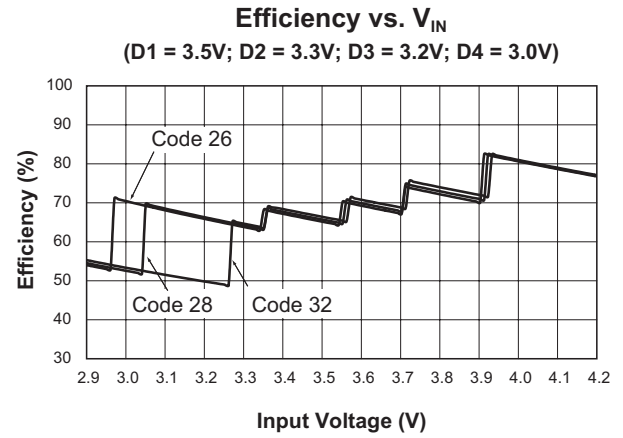
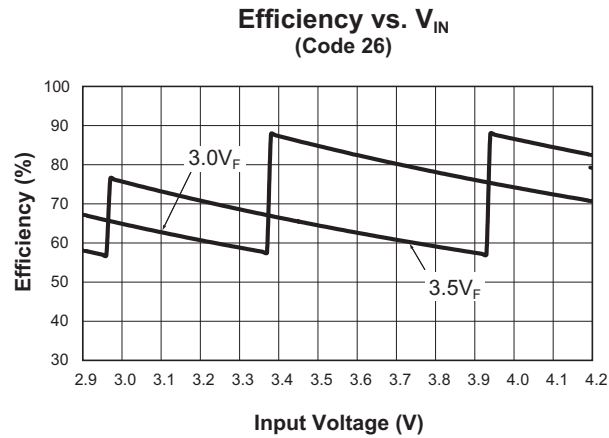

### Typical Characteristics—White LED Backlight Driver Section

$V_{IN} = 3.5V$ ,  $C_{IN} = 2.2\mu F$ ,  $C_{CP} = C1 = C2 = 1.0\mu F$ ;  $T_A = 25^\circ C$ , unless otherwise noted.

**Turn-On to 1X Mode**  
(4x19mA Load)

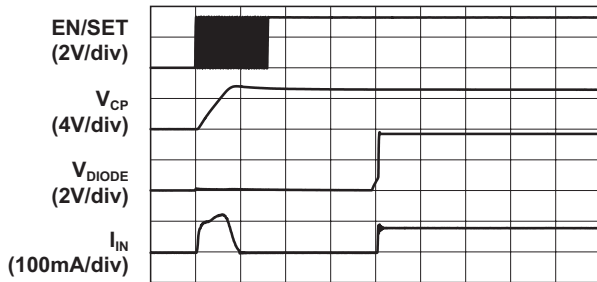

Time (100 $\mu$ s/div)

**Turn-On to 1X Mode**  
(4x30mA Load)

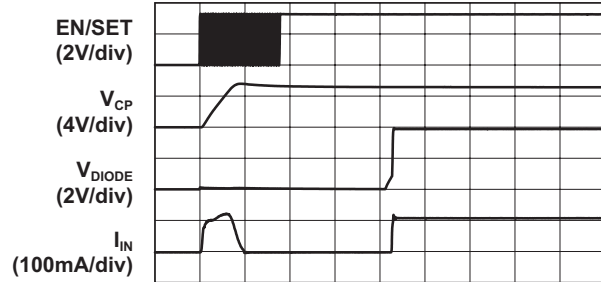

Time (100 $\mu$ s/div)

**Turn-On to 1.5X Mode**  
(4x19mA Load)

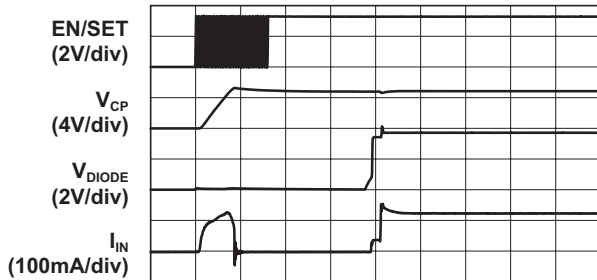

Time (100 $\mu$ s/div)

**Turn-Off from Full-Scale 2X Mode**

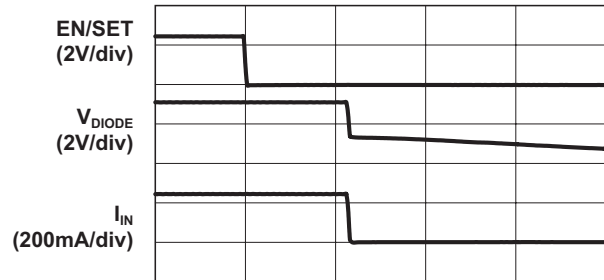

Time (100 $\mu$ s/div)

**Flash Section Turn-On**

( $V_{IN} = 3.5V$ ;  $I_{OUT} = 100mA$ ; EN/SET = GND)

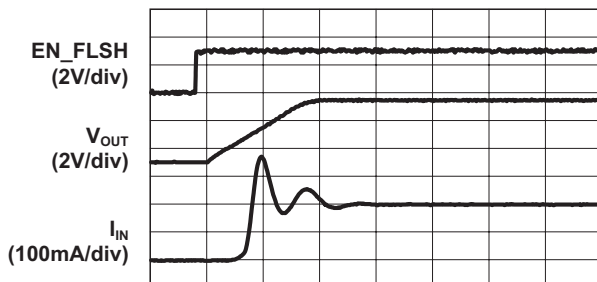

Time (100 $\mu$ s/div)

**Flash Section Turn-On**

( $V_{IN} = 3.5V$ ;  $I_{OUT} = 200mA$ ; EN/SET = GND)

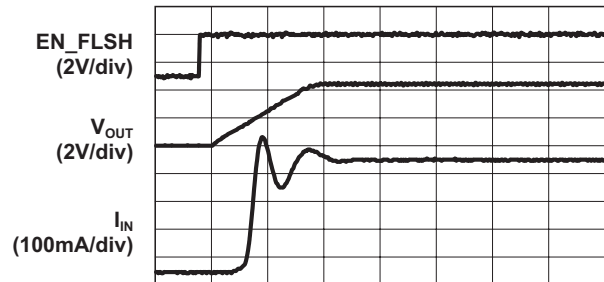

Time (100 $\mu$ s/div)

### Typical Characteristics–White LED Backlight Driver Section

$V_{IN} = 3.5V$ ,  $C_{IN} = 2.2\mu F$ ,  $C_{CP} = C1 = C2 = 1.0\mu F$ ;  $T_A = 25^\circ C$ , unless otherwise noted.

**Charge Pump to Load Switch**  
(1.5X Mode; 4x19mA Load)

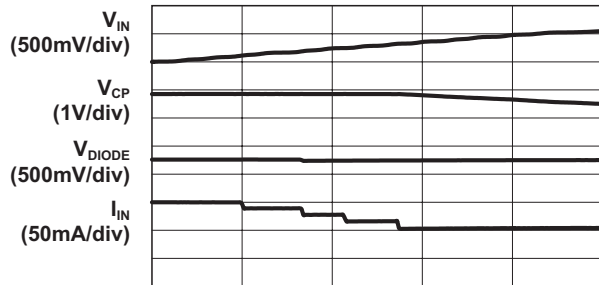

Time (5ms/div)

**Charge Pump to Load Switch**  
(1.5X Mode; 4x30mA Load)

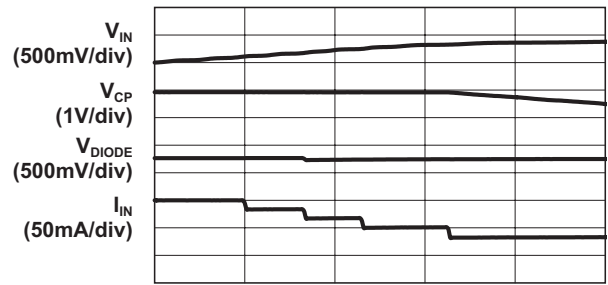

Time (5ms/div)

**Charge Pump to Load Switch**  
(2X Mode; 4x19mA Load)

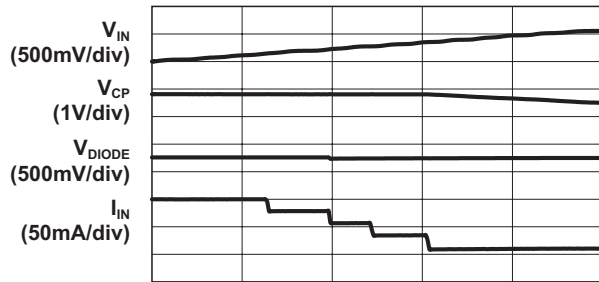

Time (5ms/div)

**Charge Pump to Load Switch**  
(2X Mode; 4x30mA Load)

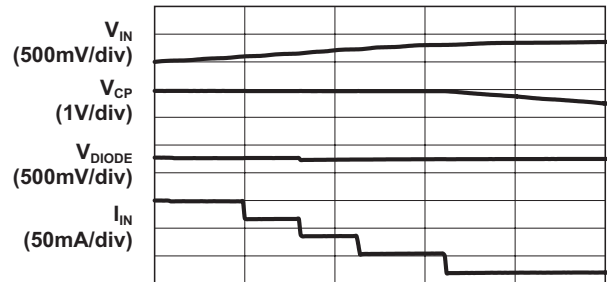

Time (5ms/div)

**Load Switch to Charge Pump**  
(1.5X Mode; 4x19mA Load)



Time (2ms/div)

**Load Switch to Charge Pump**  
(1.5X Mode; 4x30mA Load)

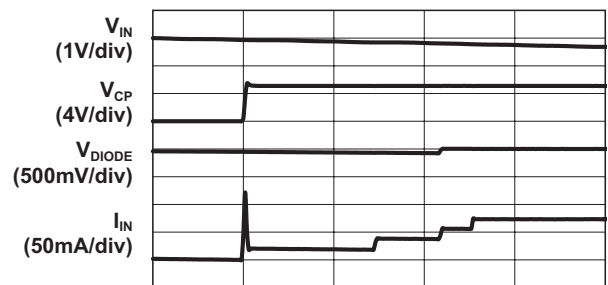

Time (2ms/div)

### Typical Characteristics—White LED Backlight Driver Section

$V_{IN} = 3.5V$ ,  $C_{IN} = 2.2\mu F$ ,  $C_{CP} = C1 = C2 = 1.0\mu F$ ;  $T_A = 25^\circ C$ , unless otherwise noted.

**Line Response**  
(1X Mode; 4x19mA Load)

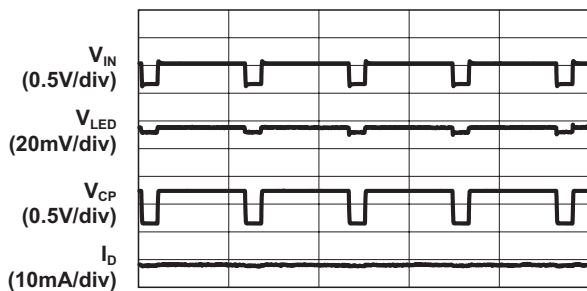

Time (1ms/div)

**Line Response**  
(1X Mode; 4x30mA Load)

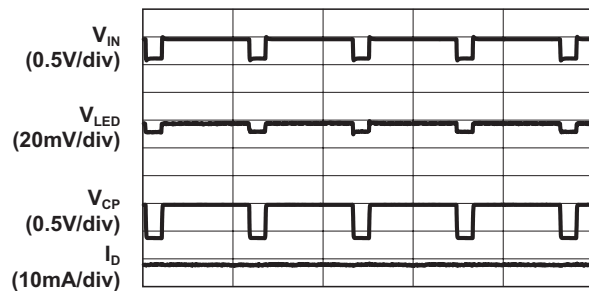

Time (1ms/div)

**Line Response**  
(1.5X Mode; 4x19mA Load)

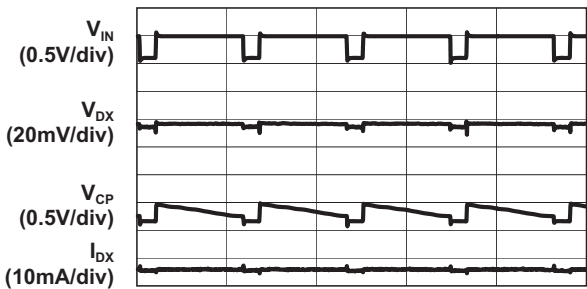

Time (1ms/div)

**Line Response**  
(1.5X Mode; 4x30mA Load)

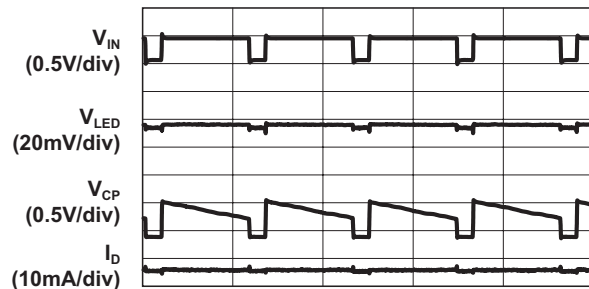

Time (1ms/div)

**Line Response**  
( $I_{OUT} = 100mA$ ;  $I_{DX} = 4x19mA$ ; 1.5X Mode)

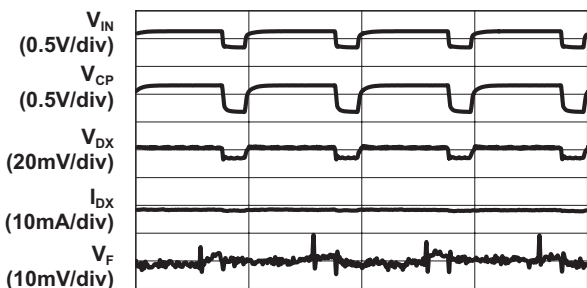

Time (1ms/div)



### Typical Characteristics—White LED Backlight Driver Section

$V_{IN} = 3.5V$ ,  $C_{IN} = 2.2\mu F$ ,  $C_{CP} = C1 = C2 = 1.0\mu F$ ;  $T_A = 25^\circ C$ , unless otherwise noted.

**Operating Characteristics**  
( $I_{Dx} = 4 \times 15mA$ ; 1.5X Mode)

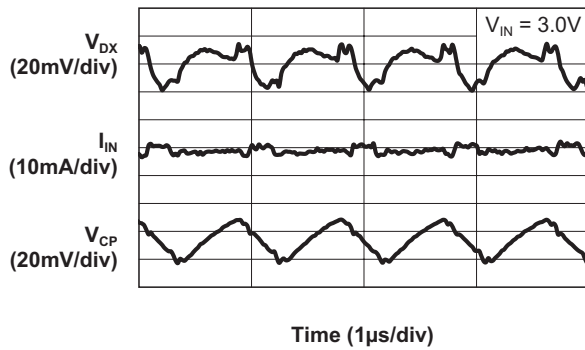

**Operating Characteristics**  
( $I_{Dx} = 4 \times 15mA$ ; 1.5X Mode;  $I_{OUT} = 100mA$ )

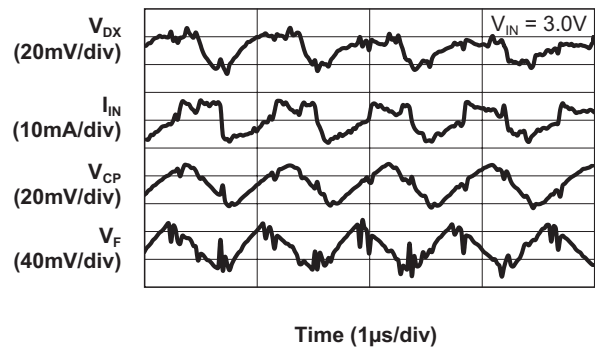

**Operating Characteristics**  
( $I_{Dx} = 4 \times 30mA$ ; 1.5X Mode)

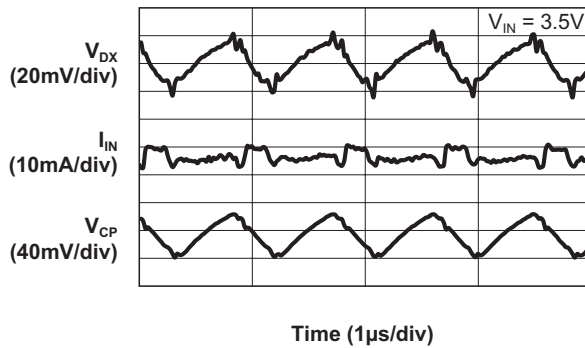

**Operating Characteristics**  
( $I_{Dx} = 4 \times 30mA$ ; 1.5X Mode;  $I_{OUT} = 100mA$ )

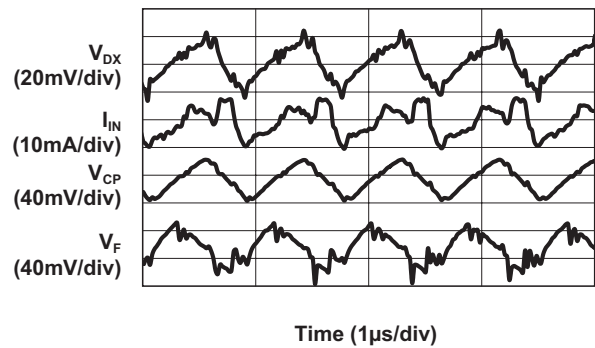

**Input Current vs. Input Voltage**  
( $4 \times 10mA$ )

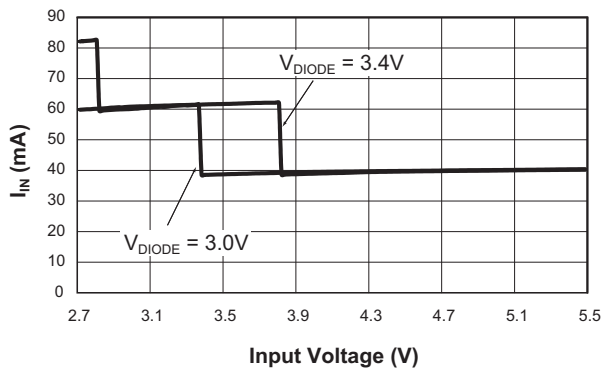

**Input Current vs. Input Voltage**  
( $4 \times 30mA$ )

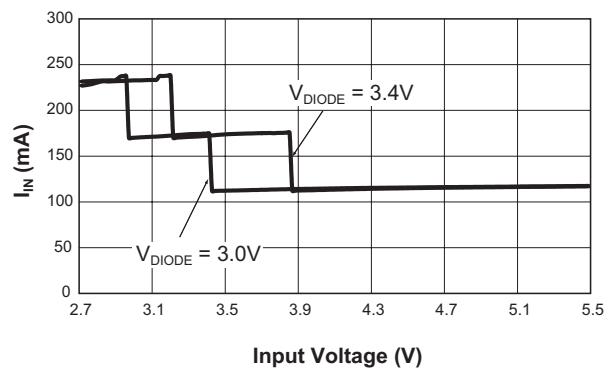

### Typical Characteristics–White LED Backlight Driver Section

$V_{IN} = 3.5V$ ,  $C_{IN} = 2.2\mu F$ ,  $C_{CP} = C1 = C2 = 1.0\mu F$ ;  $T_A = 25^\circ C$ , unless otherwise noted.

**Diode Current vs. Input Voltage**  
(30mA; 15mA settings)

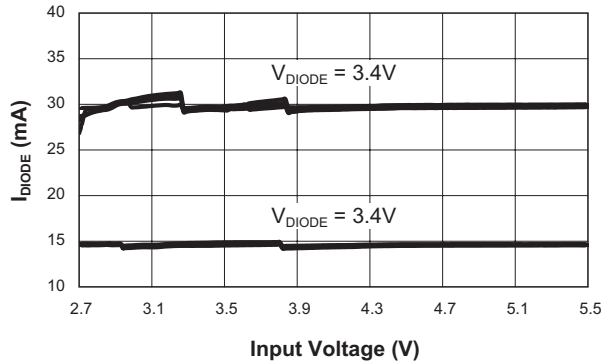

**$V_{IH}$  and  $V_{IL}$  vs.  $V_{IN}$**

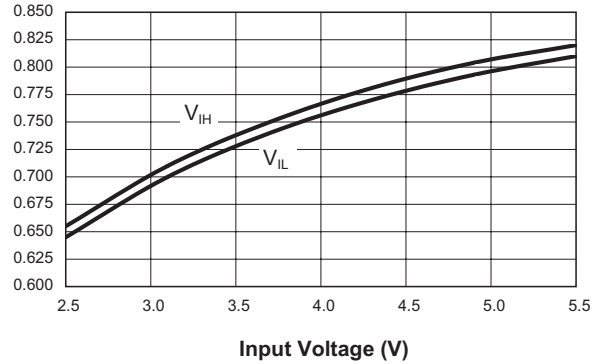

### Typical Characteristics—Flash Driver Charge Pump Section

$V_{IN} = 3.5V$ ,  $C_{IN} = 2.2\mu F$ ,  $C_3 = C_F = 1.0\mu F$ ,  $T_A = 25^\circ C$ , unless otherwise noted.

**Output Voltage vs. Output Current**

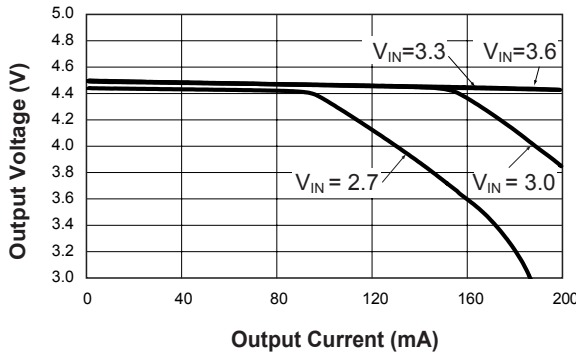

**Efficiency vs. Supply Voltage**

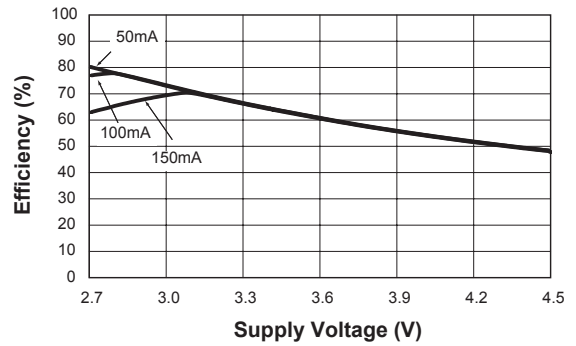

**Efficiency vs. Load Current**

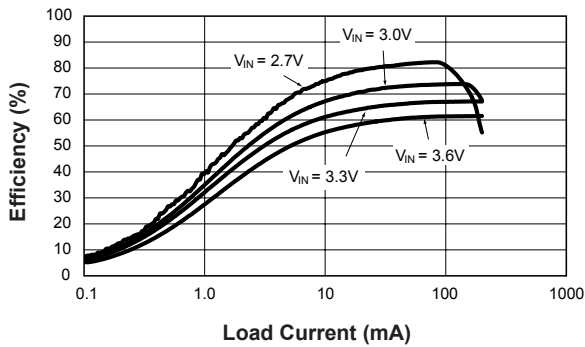

**Maximum Current Pulse vs. Supply Voltage**

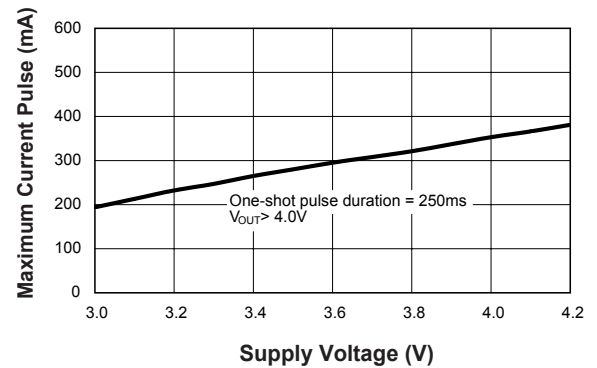

**Load Response (100mA Load)**

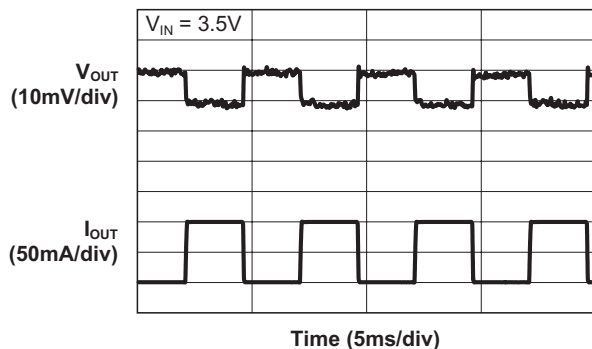

**Load Response (50mA Load)**

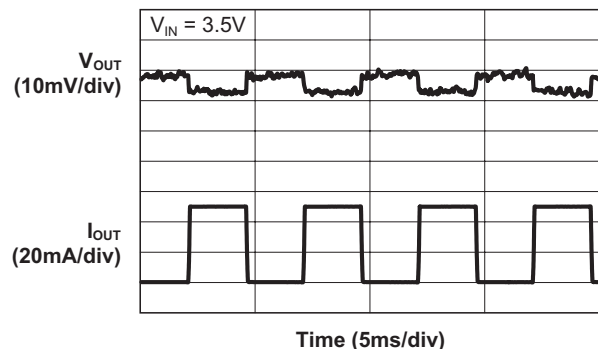

### Typical Characteristics–Flash Driver Charge Pump Section

$V_{IN} = 3.5V$ ,  $C_{IN} = 2.2\mu F$ ,  $C_3 = C_F = 1.0\mu F$ ,  $T_A = 25^\circ C$ , unless otherwise noted.

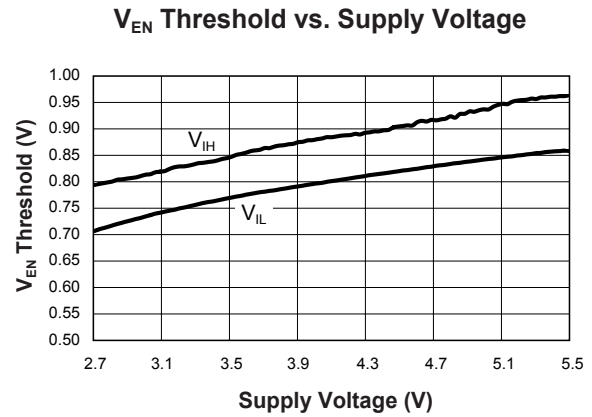
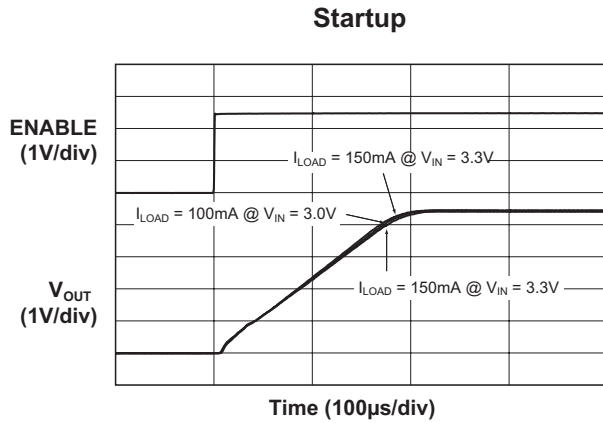

#### Normalized Output Voltage vs. Temperature

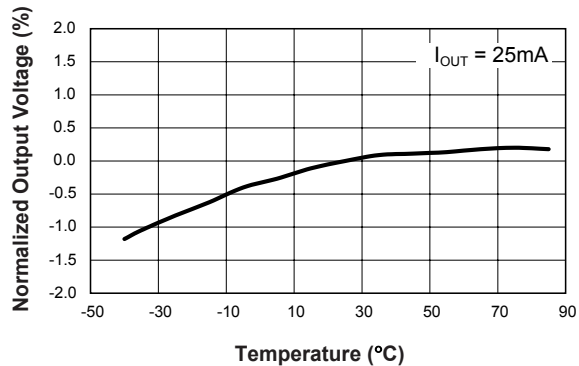

### Functional Block Diagram

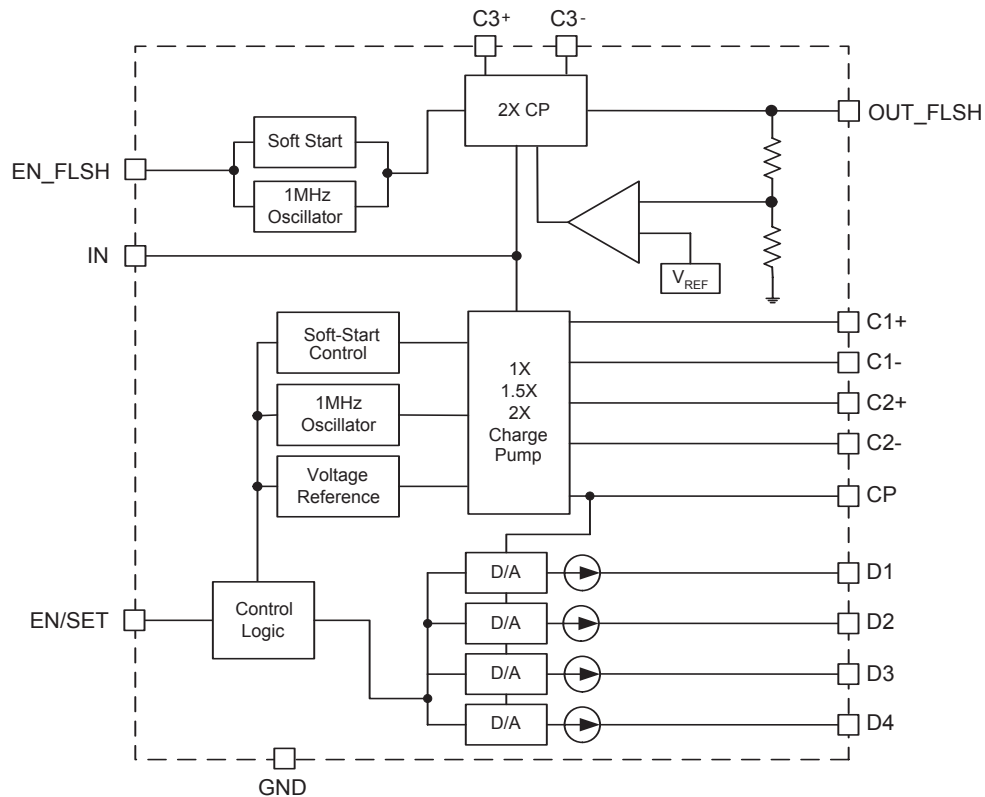

### Functional Description

The AAT2801 is a dual charge pump for white LED and flash applications. The charge pump for white LED application is a tri-mode load switch (1X) and high efficiency (1.5X or 2X) charge pump device intended for white LED backlight applications. To maximize power conversion efficiency, an internal sensing circuit monitors the voltage required on each constant current source output and sets the load switch and charge pump modes based on the input battery voltage and the current source output voltage. As the battery discharges over time, the AAT2801 charge pump is enabled when any of the four current source outputs nears dropout. The charge pump initially

starts in 1.5X mode. If the charge pump output drops enough for any current source output to become close to dropout, the charge pump will automatically transition to 2X mode.

The second section of the AAT2801 contains a voltage doubling charge pump to supply flash LED functions. The voltage doubling charge pump provides a 4.5V regulated output and has an independent enable control.

### AutoBias Technology

Each of the four current source outputs for the white LED backlight charge pump section is independently switched between the battery input (1X) or the charge pump output (1.5X or 2X), depending

on the voltage at the current source output. Since the LED to LED  $V_F$  can vary as much as 1 volt, this function significantly enhances overall efficiency of the white LED backlight charge pump section when the battery input voltage level is greater than the voltage required at any current source output.

### Flash Driver

For flash applications, the voltage doubling charge pump section is used to support the high current demand required by the application. Charge pump regulation is achieved by sensing the output voltage through an internal resistor divider network. The free running charge pump switching frequency is approximately 1MHz. The charge pump is designed to deliver up to 120mA of continuous current and 250mA of pulsed current for up to 500ms.

The AAT2801 requires only six external components: three 1 $\mu$ F ceramic capacitors for the charge pump flying capacitors (C1, C2 and C3), one 1 $\mu$ F ceramic input capacitor ( $C_{IN}$ ), one 1 $\mu$ F ceramic charge pump output capacitor ( $C_{CP}$ ), and one 1 $\mu$ F for the flash output ( $C_F$ ). The four constant current outputs (D1 to D4) drive four individual LEDs with a maximum current of 30mA each. The EN/SET S<sup>2</sup>Cwire serial interface enables the AAT2801 and sets the current source magnitudes. A separate flash enable pin (EN\_FLASH) is provided to independently control the flash charge pump circuit.

### Applications Information— White LED Backlight Section

#### Constant Current Output Level Settings

The constant current source amplitudes for D1 to D4 are set via the serial interface according to a logarithmic scale, where each code is 1dB greater than the previous code. In this manner, LED brightness appears linear with each increasing code count. Because the outputs D1 to D4 are true independent constant current sources, the voltage observed on any single given output will be determined by the actual forward voltage ( $V_F$ ) for the LED being driven.

Since the output current of the AAT2801 is programmable, no PWM (pulse width modulation) or additional control circuitry is needed to control LED brightness. This feature greatly reduces the burden on a microcontroller or system IC to manage LED or display brightness, allowing the user to "set it and forget it." With its high-speed serial interface (1MHz data rate), the output current of the AAT2801 can be changed successively to brighten or dim LEDs in smooth transitions (e.g., to fade-out) or in abrupt steps, giving the user complete programmability and real-time control of LED brightness.

The 32 individual current level settings are each approximately 1dB apart (see Current Level Settings below). Code 32 is full scale; Code 2 is full scale attenuated by 31dB; and Code 1 is reserved as a "no current" setting.

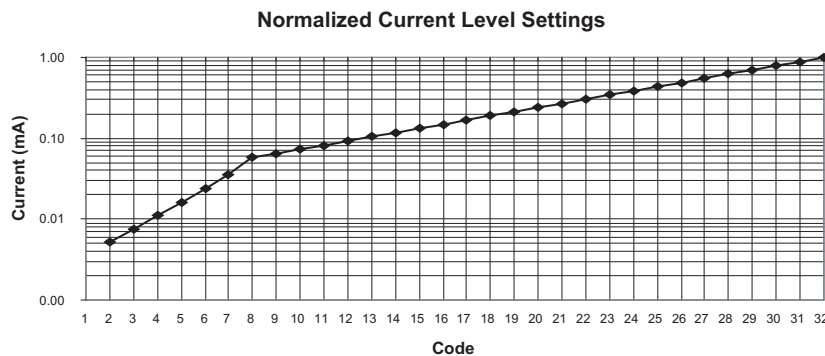

### Constant Current Source Output Nominal Programming Levels (mA)

Code	I <sub>OUT</sub> (typ) (mA)	Code	I <sub>OUT</sub> (typ) (mA)
1	0.0	17	5.1
2	0.1	18	5.6
3	0.2	19	6.4
4	0.4	20	7.2
5	0.5	21	8.1
6	0.7	22	9.2
7	1.1	23	10.2
8	1.8	24	11.5
9	2.0	25	13.1
10	2.2	26	14.7
11	2.5	27	16.6
12	2.8	28	18.6
13	3.2	29	20.9
14	3.5	30	23.6
15	4.0	31	26.6
16	4.5	32	30.0

### S<sup>2</sup>Cwire Serial Interface

The current source output magnitude is controlled by the EN/SET pin, using AnalogicTech's S<sup>2</sup>Cwire interface. The interface records rising edges of the EN/SET pin and decodes them into 32 individual current level settings each 1dB apart with Code 1 reserved for no current. Once EN/SET has been held in the logic high state for time T<sub>LAT</sub>, the programmed current is seen at the current source outputs, and the internal data register is reset to 0. For subsequent current level programming, the number of rising edges corresponding to the desired code must be entered on the EN/SET pin.

When EN/SET is held low for an amount of time greater than T<sub>OFF</sub>, the AAT2801 enters into shut-down mode and draws less than 1μA from V<sub>IN</sub>. The internal data register is reset to 0 during shut-down.

### S<sup>2</sup>Cwire Serial Interface Timing Diagram

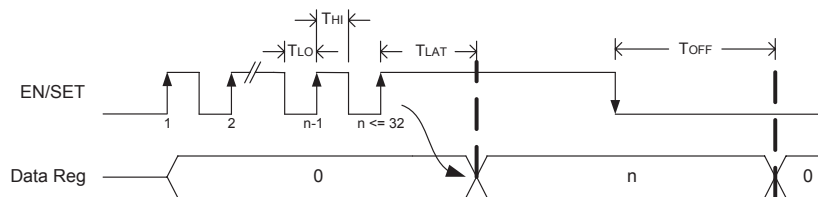

### Termination of Unused Current Source Outputs

If any outputs (D1 to D4) are not used, they should be terminated by connecting the respective unused output directly to ground. This is required to assure correct charge pump mode operation. If a given unused output is not terminated to ground, it will appear to the respective output's feedback control as an infinite impedance load and the unused constant current source will be set to maximum voltage. Although no current flows from the unused current source, the voltage sensed at that node could force the charge pump control to activate the

charge pump when it is not necessary. To prevent this effect, simply connect unused constant current source outputs to ground.

### LED Selection

The AAT2801 is specifically intended for driving white LEDs. However, the device design will allow the AAT2801 to drive most types of LEDs with forward voltage specifications ranging from 2.0V to 4.3V. Since the D1 to D4 output current sources are matched with negligible voltage dependence, the LED brightness will be matched regardless of the specific LED forward voltage (V<sub>F</sub>) levels.

### Applications Information— White LED Charge Pump Section

#### Power Efficiency and Device Evaluation

The charge pump efficiency discussion in the following sections only accounts for efficiency of the charge pump section itself. Due to the unique circuit architecture and design of the AAT2801, it is very difficult to measure efficiency in terms of a percent value comparing input power over output power.

Since the AAT2801 outputs are pure constant current sources and typically drive individual loads, it is difficult to measure the output voltage for a given output (D1 to D4) to derive an overall output power measurement. For any given application, white LED forward voltage levels can differ, yet the output drive current will be maintained as a constant.

This makes quantifying output power a difficult task when taken in the context of comparing to other white LED driver circuit topologies. A better way to quantify total device efficiency is to observe the total input power to the device for a given LED current drive level. The best white LED driver for a given application should be based on trade-offs of size, external components count, reliability, operating range, and total energy usage...*not just "% efficiency."*

Efficiency of the AAT2801 can be quantified under very specific conditions and is dependent upon the input voltage versus the output voltage seen across the loads applied to outputs D1 through D4 for a given constant current setting. Depending upon the case of  $V_{IN}$  being greater than the specific voltage seen across the load on D1 to D4, the device will operate in load switch mode. If the voltage seen on any constant current source output is less than  $V_{IN}$ , then the device will operate in 1.5X or 2X charge pump mode. Each of these modes will yield different efficiency values. One should refer to the following two sections for explanations for each operational mode.

#### Load Switch Mode Efficiency

The AAT2801 load switch mode is operational at all times and functions alone to enhance device power conversion efficiency when the condition exists where  $V_{IN}$  is greater than voltage across the load connected to the constant current source outputs. When in load switch mode, the voltage conversion efficiency is defined as output power divided by input power:

$$\eta = \frac{P_{OUT}}{P_{IN}}$$

The expression to define the ideal efficiency ( $\eta$ ) can be rewritten as:

$$\eta = \frac{P_{OUT}}{P_{IN}} = \frac{V_{OUT} \times I_{OUT}}{V_{IN} \times I_{OUT}} = \frac{V_{OUT}}{V_{IN}}$$

-or-

$$\eta(\%) = 100 \left( \frac{V_{OUT}}{V_{IN}} \right)$$

#### Charge Pump Section Efficiency

The AAT2801 contains a dual mode fractional and voltage doubling charge pump which will boost the input supply voltage in the event where  $V_{IN}$  is less than the voltage required on the constant current source outputs. The efficiency ( $\eta$ ) can be simply defined as a linear voltage regulator with an effective output voltage that is equal to one and one half or two times the input voltage. Efficiency ( $\eta$ ) for an ideal 1.5X charge pump can typically be expressed as the output power divided by the input power.

$$\eta = \frac{P_{OUT}}{P_{IN}}$$



In addition, with an ideal 1.5X charge pump, the output current may be expressed as 2/3 of the input current. The expression to define the ideal efficiency ( $\eta$ ) can be rewritten as:

$$\eta = \frac{P_{OUT}}{P_{IN}} = \frac{V_{OUT} \times I_{OUT}}{V_{IN} \times 1.5I_{OUT}} = \frac{V_{OUT}}{1.5V_{IN}}$$

-or-

$$\eta(\%) = 100 \left( \frac{V_{OUT}}{1.5V_{IN}} \right)$$

For the voltage doubling charge pump mode, the expression to define the ideal efficiency ( $\eta$ ) can be rewritten as:

$$\eta = \frac{P_{OUT}}{P_{IN}} = \frac{V_{OUT} \times I_{OUT}}{V_{IN} \times 2I_{OUT}} = \frac{V_{OUT}}{2V_{IN}}$$

-or-

$$\eta(\%) = 100 \left( \frac{V_{OUT}}{2V_{IN}} \right)$$

The flash driver charge pump section utilizes a 2X voltage doubling topology; thus, the same efficiency equation may be used to calculate the flash charge pump efficiency.

### Capacitor Selection

Careful selection of the six external capacitors  $C_{IN}$ , C1, C2, C3,  $C_{CP}$ , and  $C_F$  is important because they will affect turn-on time, output ripple, and transient performance. Optimum performance will be obtained when low equivalent series resistance (ESR) ceramic capacitors are used. In general, low ESR may be defined as less than 100m $\Omega$ . A value of 1 $\mu$ F for all six capacitors is a good starting point when choosing capacitors. If the LED current sources are only programmed for light current lev-

els, then the capacitor size may be decreased. Conversely, if the flash driver charge pump is to provide the maximum flash current of 250mA,  $C_{IN}$  may be increased to 2.2 $\mu$ F or more to reduce the load transient effects of the flash driver output.

### Capacitor Characteristics

Ceramic composition capacitors are highly recommended over all other types of capacitors for use with the AAT2801. Ceramic capacitors offer many advantages over their tantalum and aluminum electrolytic counterparts. A ceramic capacitor typically has very low ESR, is lowest cost, has a smaller PCB footprint, and is non-polarized. Low ESR ceramic capacitors help maximize charge pump transient response. Since ceramic capacitors are non-polarized, they are not prone to incorrect connection damage.

### Thermal Protection

The AAT2801 has a thermal protection circuit that will shut down the charge pump if the die temperature rises above the thermal limit.

### Flash LED Driver

The AAT2801 flash driver charge pump circuit can source 250mA for pulsed loads up to 500ms from an input supply as low as 3.3V. This makes the device well suited for low-cost flash LED driver applications in portable products. Typically the 4.5V flash output (OUT\_FLASH) version of the AAT2801 should be selected for photo flash LED applications, as it can maintain better voltage regulation at higher pulsed load current levels (refer to Figure 1). The limitation of this option is that the greatest flash LED forward voltage ( $V_F$ ) that can be driven is 4.5V at the maximum set forward current ( $I_F$ ) for the application. Flash LEDs with forward voltage ( $V_F$ ) levels up to 5.0V can be driven by the AAT2801 5.0V output option. However, the maximum current for a 500ms pulse will be reduced. Refer to the Typical Characteristics flash driver curves for peak output current levels for a given minimum input voltage.

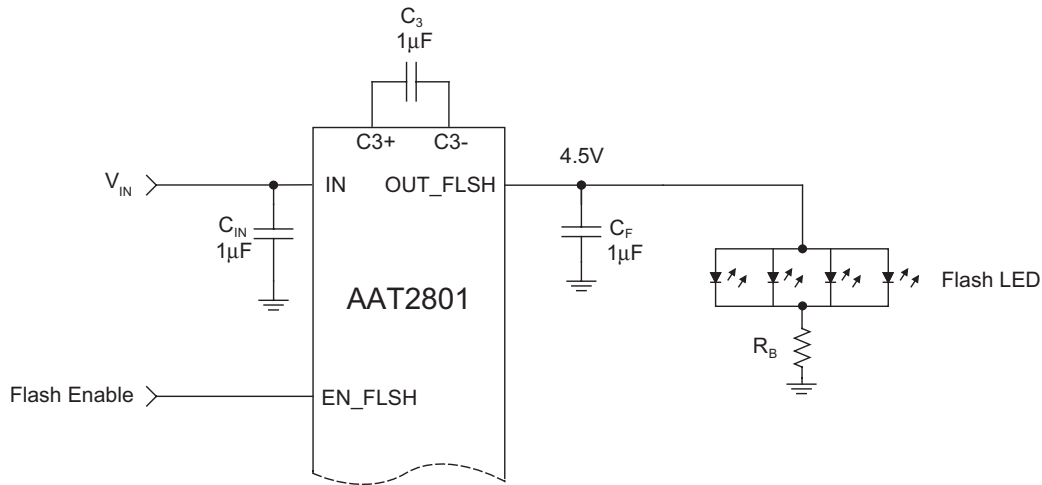

**Figure 1: Flash LED Application.**

The forward current ( $I_F$ ) through the flash LED may be determined with the use of a series ballast resistor. The typical forward voltage ( $V_F$ ) for the flash LED in a given application should be derived from the LED manufacturer's datasheet for the desired forward current ( $I_F$ ) of the flash application. Once the forward current has been determined, the flash ballast resistor can be calculated using the following equation:

$$R_B = \frac{(V_{OUT} - V_F)}{I_F}$$

Where:

- $R_B$  = Flash ballast resistor value in ohms ( $\Omega$ )
- $V_{OUT}$  = Regulated charge pump output voltage (typically 4.5V)
- $V_F$  = Flash LED forward voltage at the desired forward current
- $I_F$  = Desired flash LED forward current

The flash LED function can be controlled by the AAT2801 flash enable (EN\_FLASH) pin in most

applications. The device start-up time into a maximum load is about 200 $\mu$ s, thus eliminating the need for pre-flash control synchronization.

If a "light" or "movie" mode is also needed along with the flash function, this can be accomplished with the addition of a second ballast resistor with a flash function gating MOSFET switch as shown in Figure 2. Refer to the following equations for the calculation of flash and light resistors,  $R_B$  and  $R_L$ .

$$R_L = \frac{(V_{OUT} - V_F)}{I_F}$$

Where:

- $R_L$  = Light mode ballast resistor value in ohms ( $\Omega$ )
- $V_{OUT}$  = Regulated charge pump output voltage (typically 4.5V)
- $V_F$  = Flash LED forward voltage at the desired forward current
- $I_F$  = Desired flash LED forward current in the "light" mode

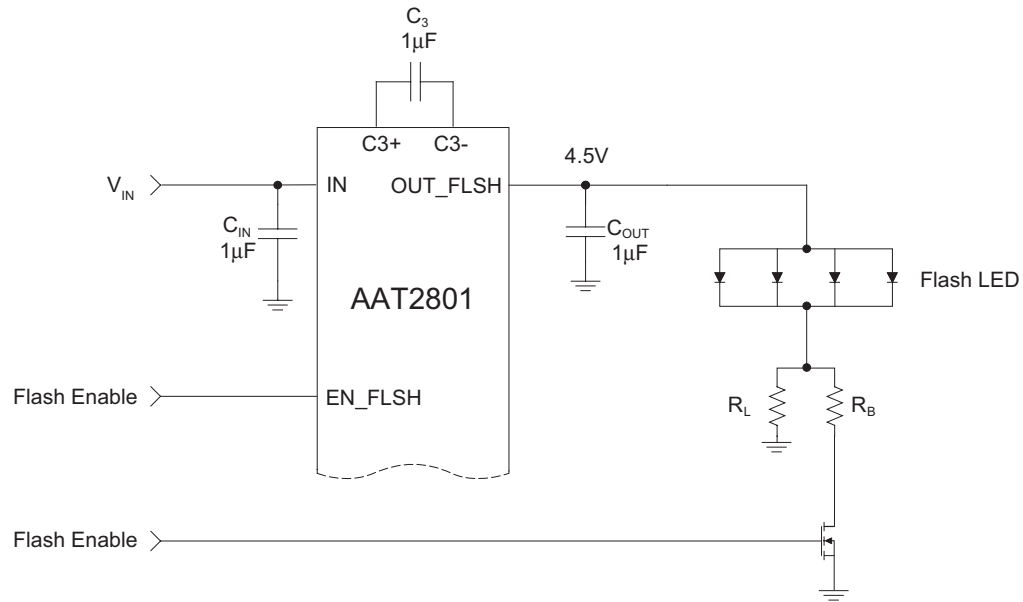

**Figure 2: Flash LED Driver with Gated Flash Application.**

$$R_B = \left[ \frac{(V_{OUT} - V_F)}{I_F} \right] - R_{DS}$$

Where:

- $R_B$  = Flash ballast resistor value in ohms ( $\Omega$ )
- $R_{DS}$  = Flash gating mosfet on resistance
- $V_{OUT}$  = Regulated charge pump output voltage (typically 4.5V)
- $V_F$  = Flash LED forward voltage at the desired forward current
- $I_F$  = Desired flash LED forward current

### Ordering Information

Output Voltage	Package	Marking <sup>1</sup>	Part Number (Tape and Reel) <sup>2</sup>
4.5V	TDFN44-16	MSXYY	<b>AAT2801IXN-4.5-T1</b>
5.0V	TDFN44-16		AAT2801IXN-5.0-T1

### Package Information

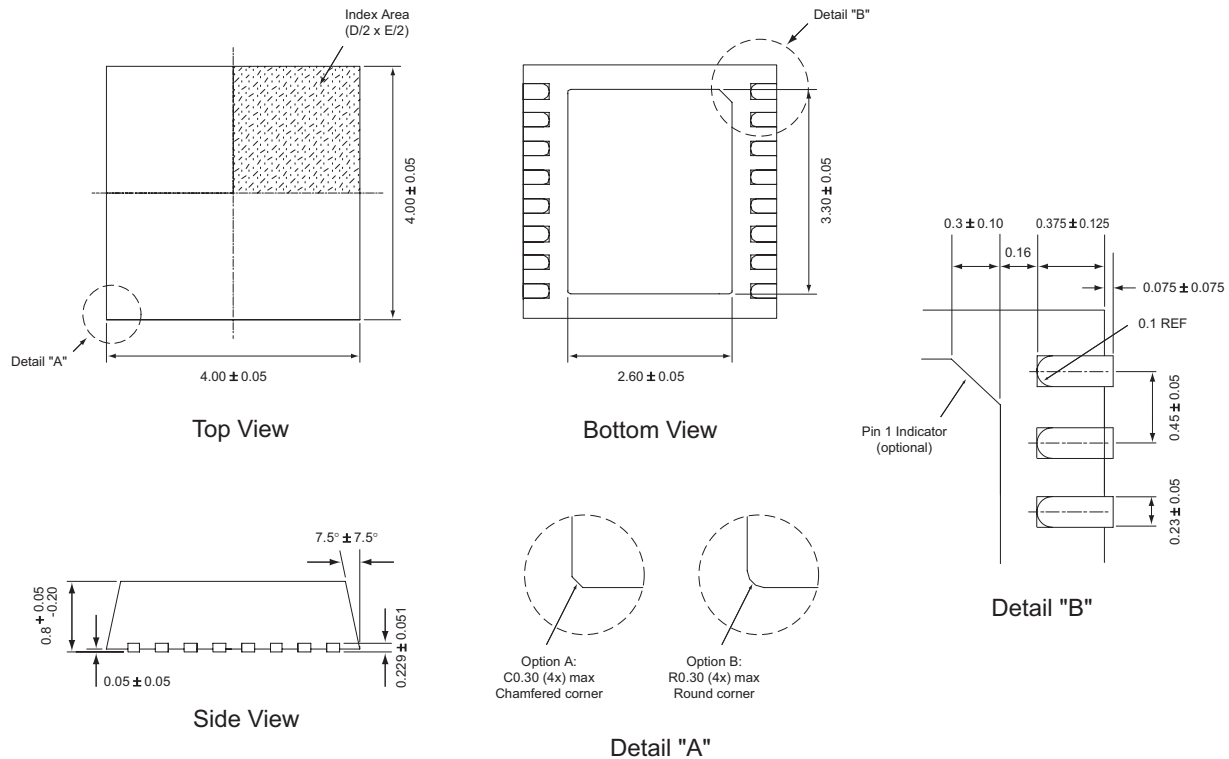

All dimensions in millimeters.

1. XYY = assembly and date code.
2. Sample stock is generally held on part numbers listed in **BOLD**.

© Advanced Analogic Technologies, Inc.

AnalogicTech cannot assume responsibility for use of any circuitry other than circuitry entirely embodied in an AnalogicTech product. No circuit patent licenses, copyrights, mask work rights, or other intellectual property rights are implied. AnalogicTech reserves the right to make changes to their products or specifications or to discontinue any product or service without notice. Customers are advised to obtain the latest version of relevant information to verify, before placing orders, that information being relied on is current and complete. All products are sold subject to the terms and conditions of sale supplied at the time of order acknowledgement, including those pertaining to warranty, patent infringement, and limitation of liability. AnalogicTech warrants performance of its semiconductor products to the specifications applicable at the time of sale in accordance with AnalogicTech's standard warranty. Testing and other quality control techniques are utilized to the extent AnalogicTech deems necessary to support this warranty. Specific testing of all parameters of each device is not necessarily performed.

AnalogicTech and the AnalogicTech logo are trademarks of Advanced Analogic Technologies Incorporated. All other brand and product names appearing in this document are registered trademarks or trademarks of their respective holders.

**Advanced Analogic Technologies, Inc.**  
 830 E. Arques Avenue, Sunnyvale, CA 94085  
 Phone (408) 737-4600  
 Fax (408) 737-4611