

Buffered H-Bridge

FEATURES

- 0.65-A H-Bridge
- 200-kHz Switching Rate
- Shoot-Through Limited
- TTL Compatible Inputs
- 3.8- to 13.2-V Operating Range
- Surface Mount Packaging
- Total $r_{DS(on)}$ for N- and P-Channel:
1.8 Ω @ $V_{DD} = 4.5$ V and $T_A = 85^\circ\text{C}$

APPLICATIONS

- VCM Driver
- Brushed Motor Driver
- Stepper Motor Driver
- Power Converter
- Optical Disk Drives
- Power Supplies
- High Performance Servo

DESCRIPTION

The Si9988 is an integrated, buffered H-bridge with TTL compatible inputs and the capability of delivering a continuous 0.65 A @ $V_{DD} = 5$ V (room temperature) at switching rates up to 200 kHz. Internal logic prevents the upper and lower outputs of either half-bridge from being turned on simultaneously. Both outputs may be forced low (for motor braking) by pulling $\overline{\text{EN}}$ to logic high.

The Si9988 is available in an 8-Pin TSSOP package, specified to operate over a voltage range of 3.8 V to 13.2 V, and the industrial temperature range of -40 to 85°C (D suffix).

FUNCTIONAL BLOCK DIAGRAM, PIN CONFIGURATION AND TRUTH TABLE

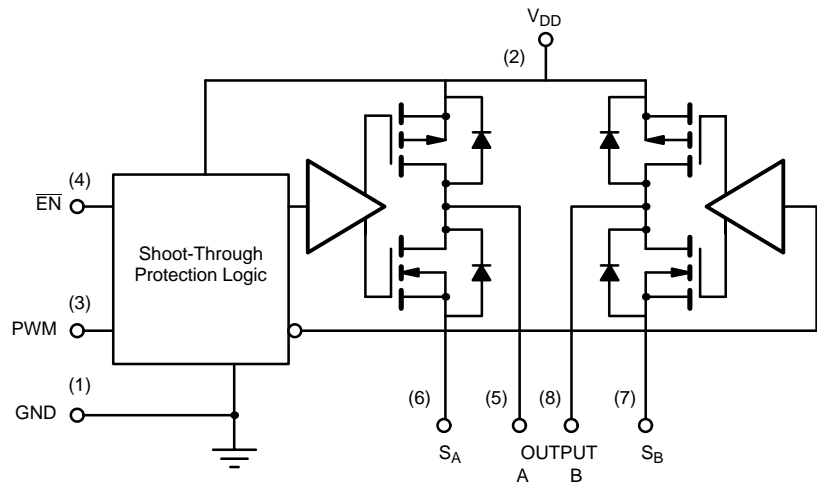
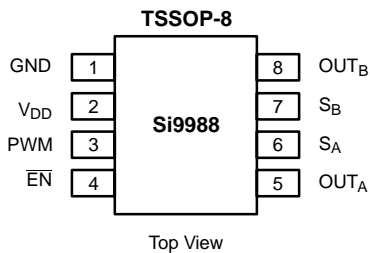

TRUTH TABLE			
$\overline{\text{EN}}$	PWM	OUT _A	OUT _B
0	0	0	1
0	1	1	0
1	0	0	0
1	1	0	0

ORDERING INFORMATION			
Part Number	Marking	Temperature Range	Package
Si9988DQ-T1	988	-40 to 85°C	Tape and Reel

**ABSOLUTE MAXIMUM RATINGS^a**

V_{DD}	15 V
Voltage on any pin with respect to ground	-0.3 V to $V_{DD} + 0.3$ V
Voltage on pins 5, 8 with respect to GND	-1 V to $V_{DD} + 1$ V
Voltage on pins 6, 7	-0.3 V to GND +1 V
Peak Output Current	1 A
Storage Temperature	-65 to 150°C
Junction Temperature (T_J)	150°C

Continuous I_{out} current ($T_J = 135^\circ\text{C}$, $Y_{DD} = 5\text{V}$)

$T_A = 25^\circ\text{C}$	0.67A
$T_A = 85^\circ\text{C}$	0.47A
Power Dissipation ^b	0.83 W
θ_{JA}	120°C/W
Operating Temperature Range	-40 to 85°C

Notes

- Device mounted with all leads soldered or welded to PC board.
- Derate 8.3 mW/°C above 25°C.
- $T_J = T_A + (P_D)(\theta_{JA})$, P_D = Power Dissipation.

Stresses beyond those listed under "Absolute Maximum Ratings" may cause permanent damage to the device. These are stress ratings only, and functional operation of the device at these or any other conditions beyond those indicated in the operational sections of the specifications is not implied. Exposure to absolute maximum rating conditions for extended periods may affect device reliability.

RECOMMENDED OPERATING RANGE

V_{DD}	3.8 V to 13.2 V
Maximum Junction Temperature (T_J)	135°C

SPECIFICATIONS							
Parameter	Symbol	Test Conditions Unless Otherwise Specified $V_{DD} = 3.8$ to 13.2 V S_A @ GND, S_B @ GND	Limits D Suffix, -40 to 85°C			Unit	
			Min ^a	Typ ^b	Max ^a		
Input ($\overline{\text{EN}}$, PWM)							
Input Voltage High	V_{INH}		2			V	
Input Voltage Low	V_{INL}				1		
Input Current with Input Voltage High	I_{INH}	$V_{IN} = 13.2$ V			1	μA	
Input Current with Input Voltage Low	I_{INL}	$V_{IN} = 0$ V	-1				
Output							
Output Voltage High ^c	V_{OUTH}	$I_{OUT} = -300$ mA	$V_{DD} = 10.8$ V	10.55	10.70	V	
			$V_{DD} = 4.5$ V	4.20	4.35		
			$V_{DD} = 3.8$ V	3.40	3.62		
Output Voltage Low ^c	V_{OUTL}	$I_{OUT} = 300$ mA	$V_{DD} = 10.8$ V		0.09	0.20	
			$V_{DD} = 4.5$ V		0.12	0.25	
			$V_{DD} = 3.8$ V		0.14	0.30	
Output V Clamp High	V_{CLH}	$\overline{\text{EN}} = \text{PWM} \geq 2$ V	$I_{OUT} = 100$ mA		$V_{DD} + 0.7$	$V_{DD} + 1.0$	V
Output V Clamp Low	V_{CLL}		$I_{OUT} = -100$ mA	-1.0	-0.7		
Supply							
V_{DD} Supply Current	I_{DD}	$\overline{\text{EN}} = 0\text{V}$, PWM = 100 kHz, $V_{DD} = 5$ V		1.0	1.5	mA	
		$\overline{\text{EN}} = 4.5$ V, PWM = 100 kHz, $V_{DD} = 5.5$ V		60	140	μA	
		$\overline{\text{EN}} = \text{PWM} = 4.5$ V, $V_{DD} = 5.5$ V		55	110		



SPECIFICATIONS						
Parameter	Symbol	Test Conditions Unless Otherwise Specified $V_{DD} = 3.8$ to 13.2 V $S_A @ GND, S_B @ GND$	Limits D Suffix, -40 to 85°C			Unit
			Min ^a	Typ ^b	Max ^a	
Dynamic						
Propogation Delay – OUT_A^d	T_{PLH}	$V_{DD} = 5$ V, $\overline{\text{EN}} = 0$ V		300		nS
	T_{PHL}			115		
Propogation Delay – OUT_B^d	T_{PLH}			75		
	T_{PHL}			330		
Break-Before-Make ^d	BBM_{PLH}			225		
	BBM_{PHL}			215		

Notes

- a. The algebraic convention whereby the most negative value is a minimum and the most positive a maximum, is used in this data sheet.
- b. Typical values are for DESIGN AID ONLY, not guaranteed nor subject to production testing, measured $T_A = 25^\circ\text{C}$.
- c. Min and Max value measured at $T_J = 135^\circ\text{C}$.
- d. PLH = PWM low to high, PHL = PWM high to low.

TYPICAL CHARACTERISTICS (25°C UNLESS NOTED)

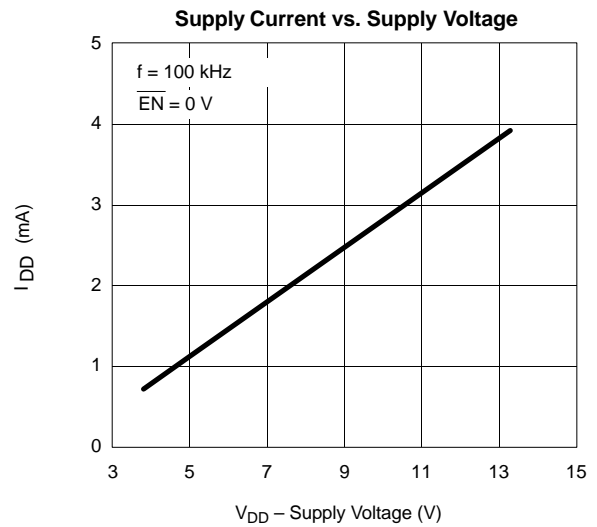
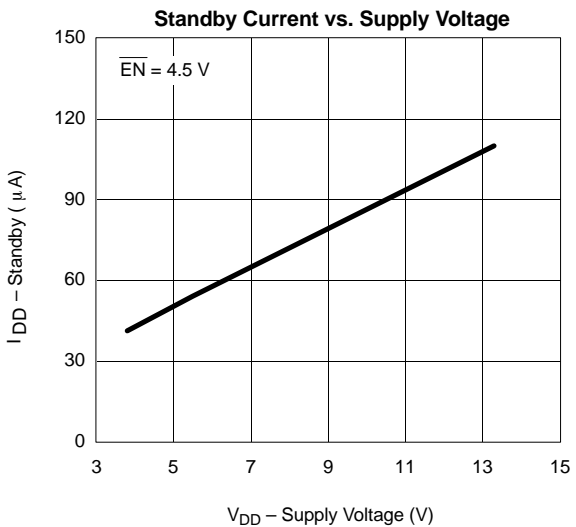
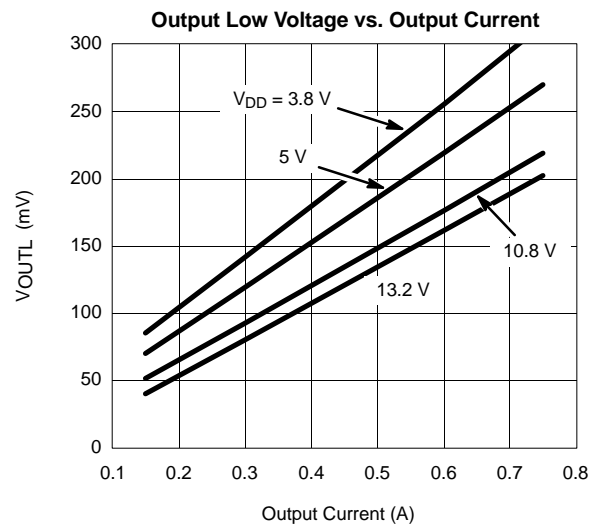
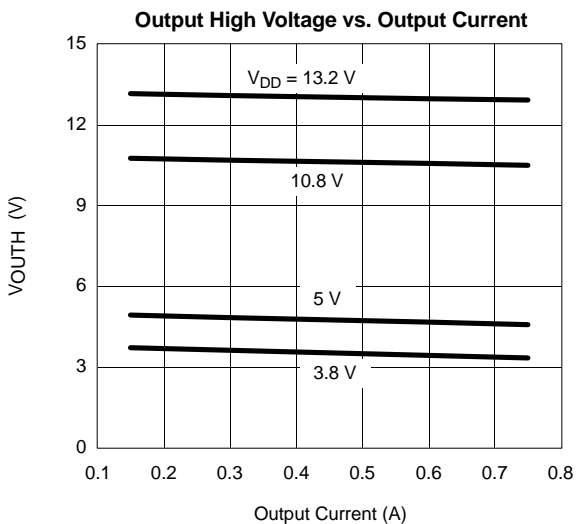



TYPICAL CHARACTERISTICS (25 °C UNLESS NOTED)

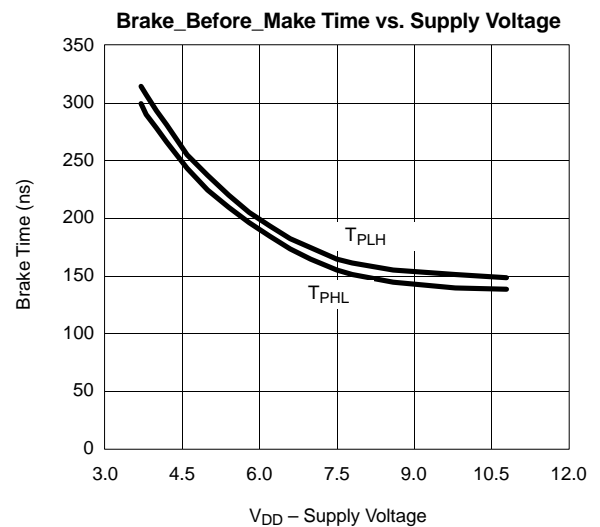
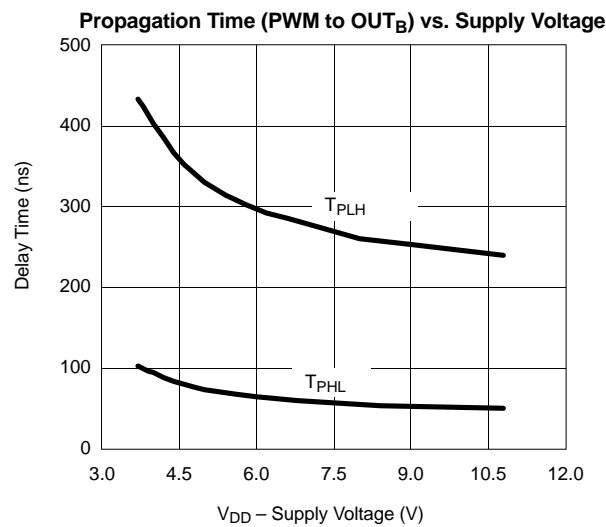
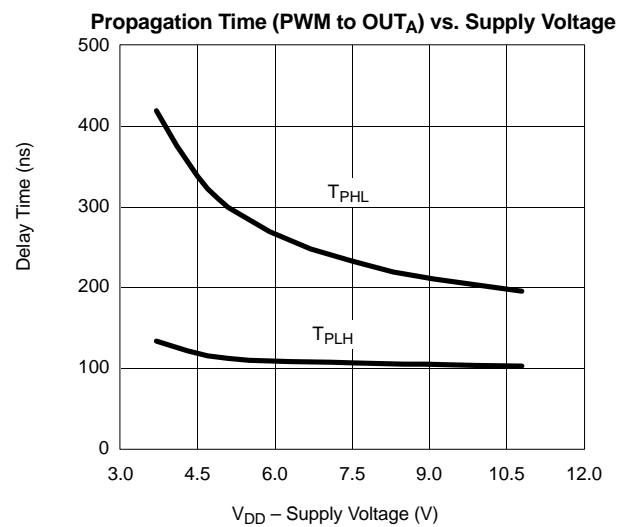
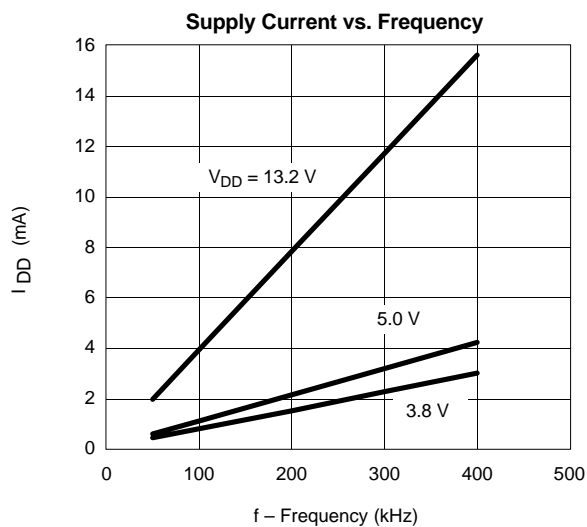
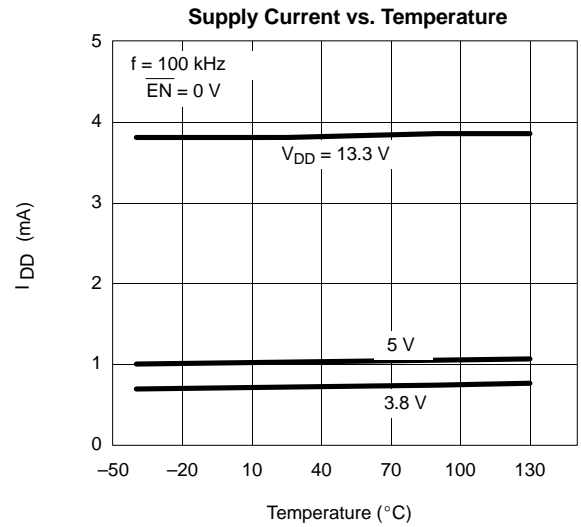
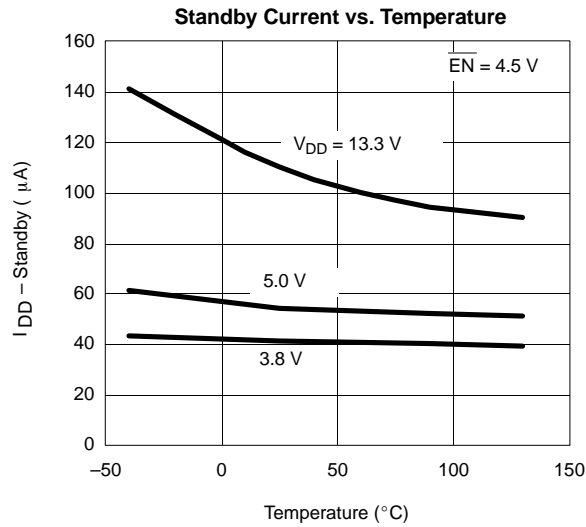

TIMING WAVEFORMS

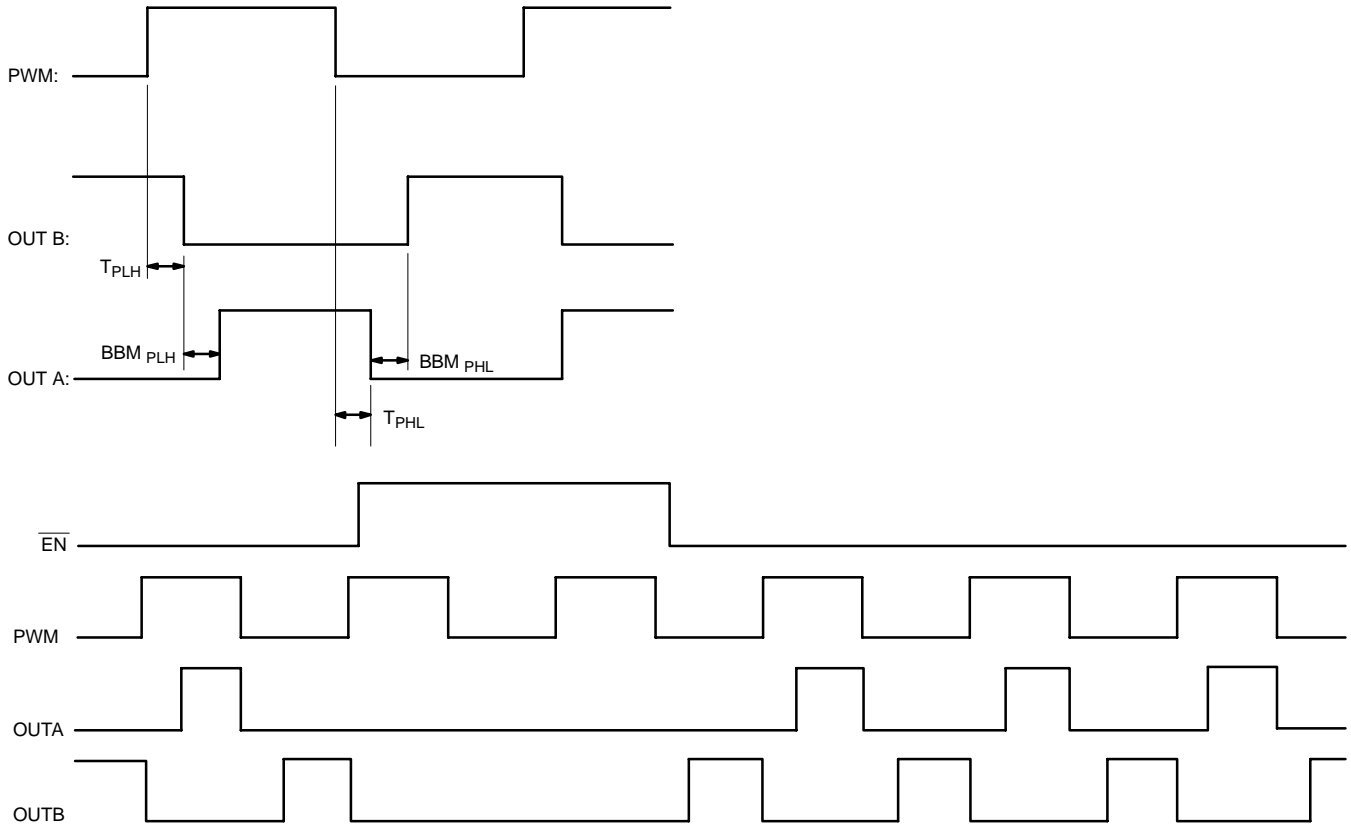

FIGURE 1.