

SPECIFICATIONS

Electrical Ratings	3A @ 120VAC, 28VDC; 1.5A @ 250VAC See contact options
Electrical Life	30,000 cycles typical
Contact Resistance	< 20 mΩ max initial @ 2-4VDC, 100mA
Dielectric Strength	1000Vrms min
Insulation Resistance	> 1,000MΩ min
Operating Temperature	-40°C to 85°C
Storage Temperature	-40°C to 85°C



Process Sealed
c **UL** US - E222871







MATERIALS ←RoHS COMPLIANT



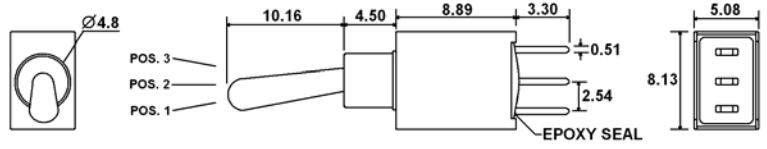

Actuator	Brass, Chrome Plated
Housing	4/6 Nylon, Glass Filled, Flame Retardant Heat Stabilized, UL94V-0
Support Bracket	Brass, Tin Plated
Contacts	Copper Alloy + Silver or Gold
Terminals	Copper Alloy + Silver or Gold

ORDERING INFORMATION

Series:	BST	1	3	T2	N	H	Q
Number of Poles:							
1 = SPDT							
2 = DPDT							
Switch Function:							
1 = ON-NONE-ON							
2 = ON-NONE-(ON)							
3 = ON-OFF-ON							
4 = (ON)-OFF-(ON) ** Only available in SPDT							
5 = ON-OFF-(ON) ** Only available in SPDT							
Actuator:							
T1 = 10.46mm, Std							
T2 = 6.10mm, Std							
T3 = 8.13mm, Std							
T4 = 13.97mm, Std							
P1 = 10.16mm, Plastic, Anti-Static							
P2 = 6.10mm, Plastic, Anti-Static							
Bushing:							
A = 4.65mm, Non-Threaded ** Only available in SPDT							
B = 5.00mm, Non-Threaded ** Only available in SPDT							
N = 4.50mm, Non-Threaded ** Only available in DPDT							
Terminals:							
C = PC Pin							
H = Horizontal Mount, Right Angle PC Pin; <i>HS</i> = Snap-in							
V = Vertical Mount, Right Angle PC Pin; <i>VS</i> = Snap-in							
A5 = PC Pin with Support Bracket; <i>A5S</i> = Snap-in Support Bracket							
Contacts:							
Q = Silver Plated							
R = Gold Plated							
G = Gold over Silver Plated							

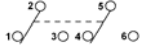
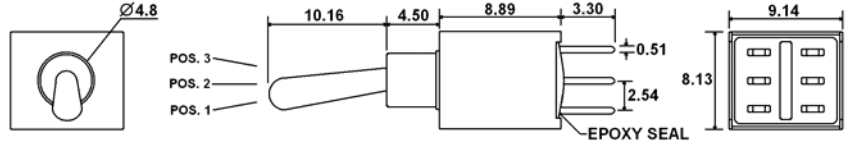
SWITCH FUNCTION

 SPDT 	Function 1 2 3 4 5 Terminals	Toggle Position			
					
		ON	NONE	ON	
		ON	NONE (ON)	(ON)	
		(ON)	OFF	(ON)	
---	---	2-1			

 DPDT 	Function 1 2 3 Terminals	Toggle Position			
					
		ON	NONE	ON	
		ON	NONE (ON)	(ON)	
		ON	OFF	ON	
---	---	2-1			

ACTUATOR OPTIONS

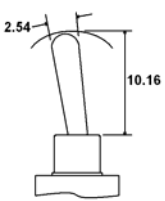
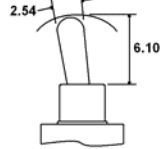
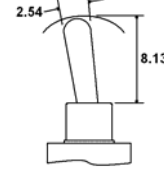
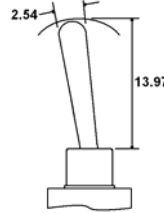
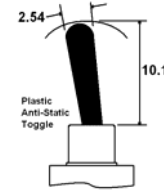
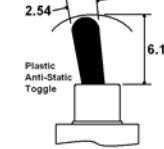
 T1	 T2	 T3	 T4	 P1	 P2
---	---	---	---	---	---

BUSHING OPTIONS

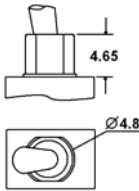
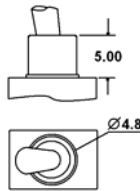
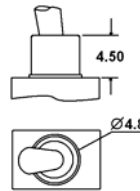
 A	 B	 N
---	---	---

TERMINAL OPTIONS

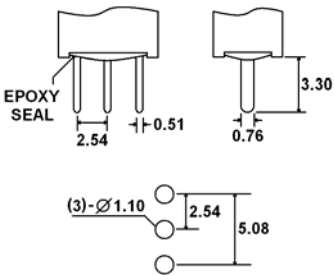
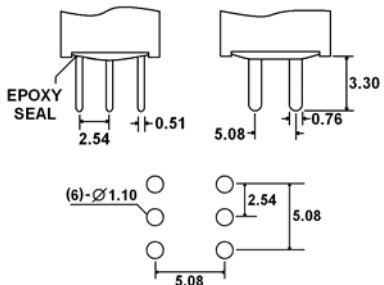
 C - SPDT	 C - DPDT
--	---

TERMINAL OPTIONS

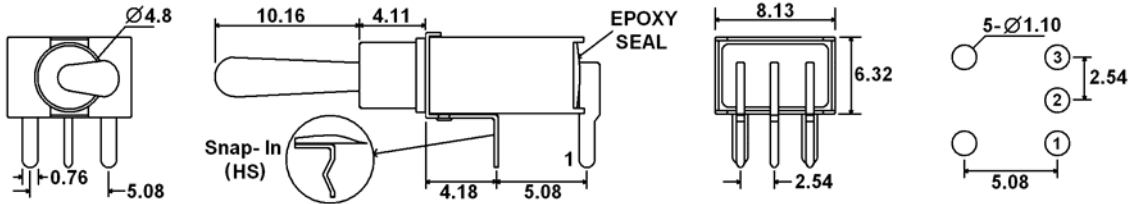

H (HS – Snap-in) = Horizontal Mount, Right Angle PC Pins (SPDT)

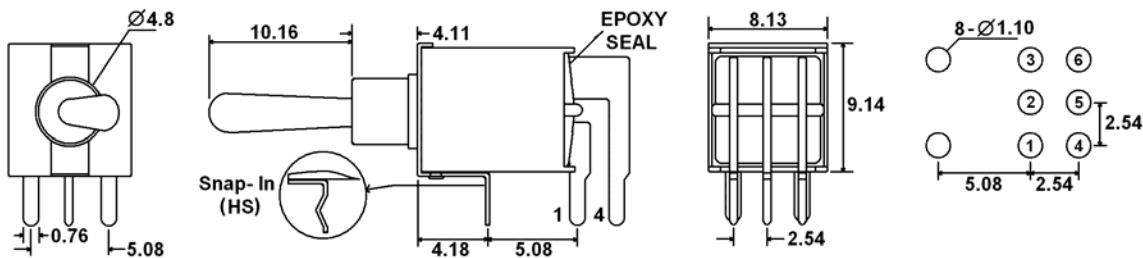

H (HS – Snap-in) = Horizontal Mount, Right Angle PC Pins (DPDT)

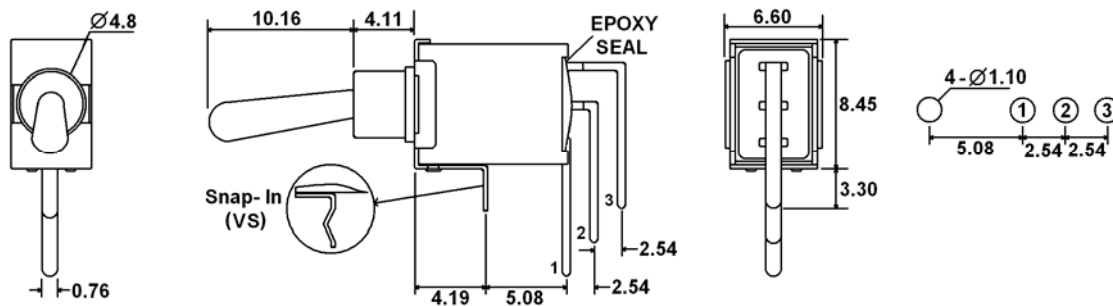

V (VS – Snap-in) = Vertical Mount, Right Angle PC Pins (SPDT)

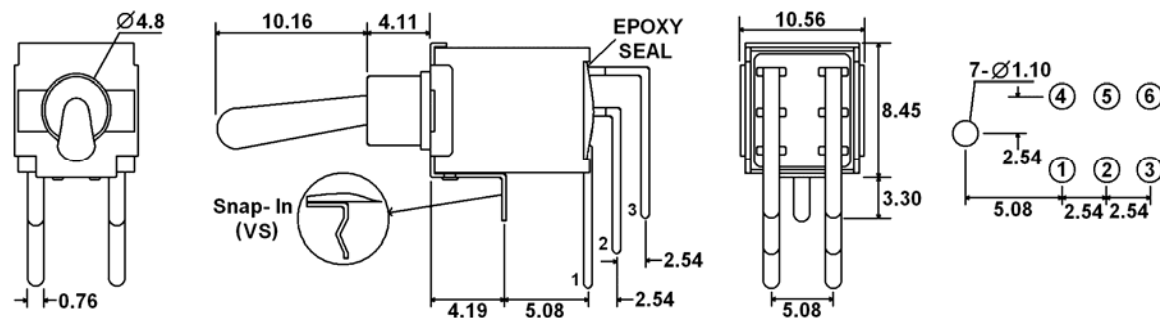

V (VS – Snap-in) = Vertical Mount, Right Angle PC Pins (DPDT)

TERMINAL OPTIONS

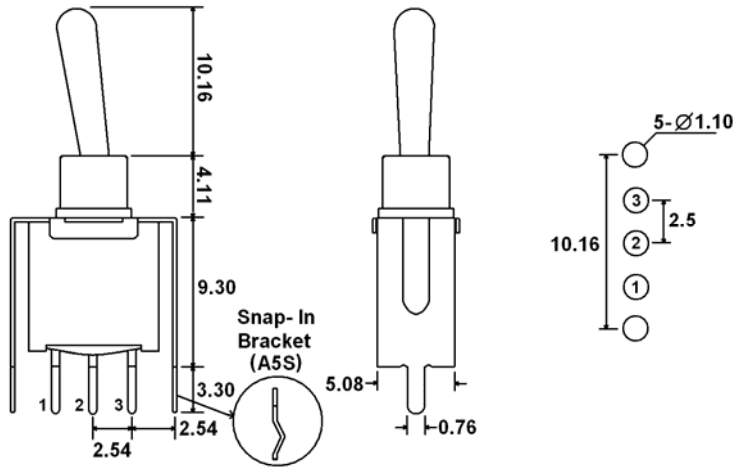

A5 (A5S – Snap-in Bracket) = PC Pins with Support Bracket (SPDT)

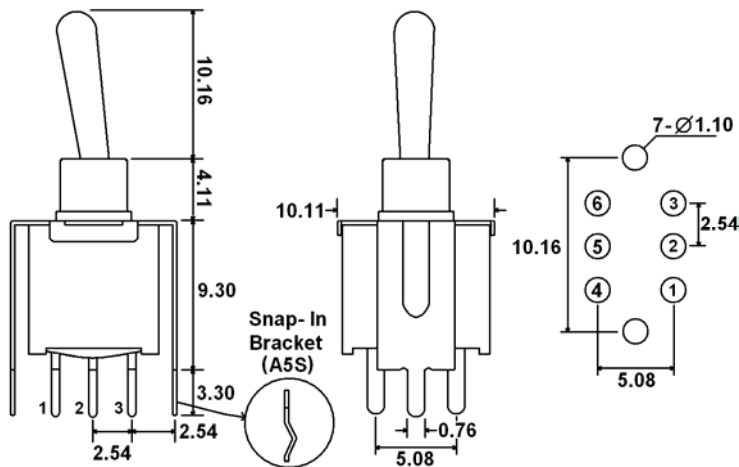

A5 (A5S – Snap-in Bracket) = PC Pins with Support Bracket (DPDT)

CONTACT OPTIONS

Designator	Contact Material	Terminal Material	Electrical Ratings
Q	Silver Plating	Silver Plating	3A @ 120VAC, 28VDC; 1.5A @ 250VAC
R	Gold over Nickel Plating	Gold over Nickel Plating	.4 VA max @ 20VAC or VDC max
G	Gold over Silver Plating	Gold over Silver Plating	.4 VA max @ 20VAC or VDC max or 3A @ 120VAC, 28VDC; 1.5A @ 250VAC