

Numeric LED

General Description

Sharp can supply wide color line-up for numeric LEDs-GaAlAs on GaAlAs (double hetero) super-luminosity U series (red), S series (sunset orange), K series (green). In addition to them, dichromatic type has realized an expressive display, changing the emission color according to display contents.

Sharp can also supply various character height (7.62mm to 38.1mm), and various digits type (1digit to 5digits) for your applications.

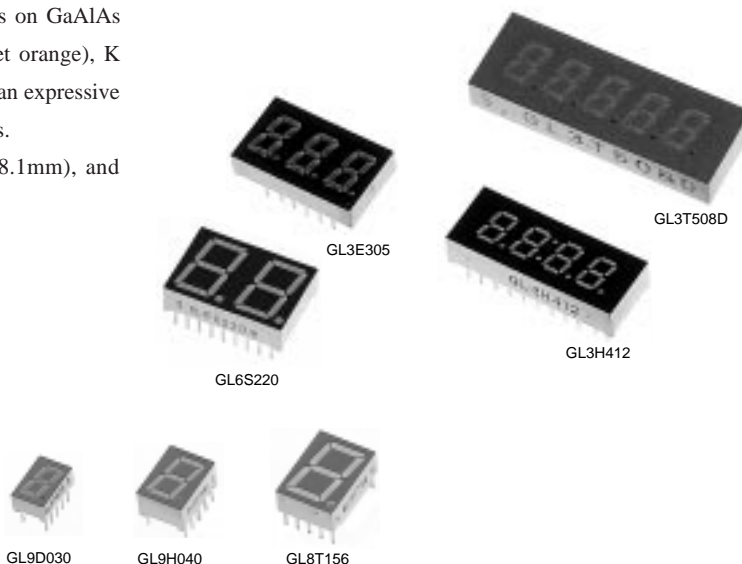

Numbering system

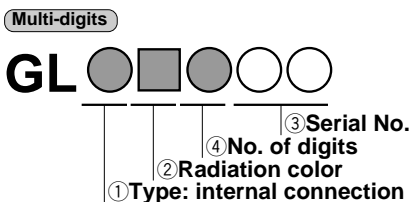
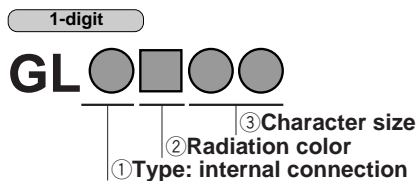

① Type: internal connection

3	Multi-digits Dynamic drive circuit
6	Multi-digits Cathode common
7	Multi-digits Anode common
8	1-digit Cathode common
9	1-digit Anode common

② Radiation color

Series	Radiation color
P	Red
U	Red(Super-luminosity)
T	Red(High-luminosity)
D	Red
S	Sunset orange
H	Yellow
E	Yellow-green
K	Green
ED	Yellow-green+Red
ET	Yellow-green+Red(High-luminosity)

③ Character size

03,030	8.0mm
04,040	10.16mm
156	14.12mm
56	14.22mm
08	20.32mm
100	25.4mm
15	38.1mm

④ No. of digits

2	2-digits
3	3-digits
4	4-digits
5	5-digits

Structure

Numeric LEDs are classified into 2 types ; substrate type and mold type as shown below. Substrate type employs thin package and can save the mount space. Mold type has realized high reliability because it is molded by resin.

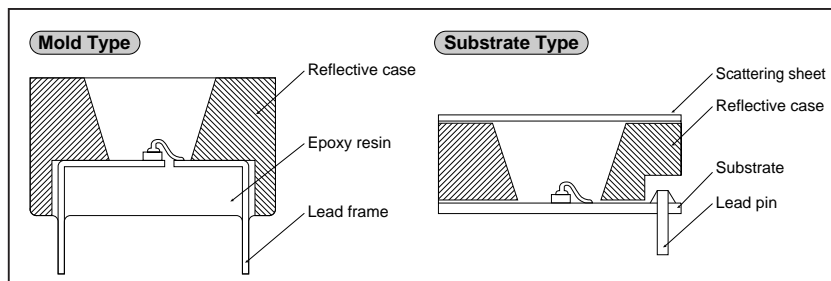

Notice In the absence of confirmation by device specification sheets, SHARP takes no responsibility for any defects that may occur in equipment using any SHARP devices shown in catalogs, data books, etc. Contact SHARP in order to obtain the latest device specification sheets before using any SHARP device.
Internet Internet address for Electronic Components Group <http://www.sharp.co.jp/ecg/>

Surface Mount Type Numeric LED

General Description

Sharp's GL8D03M series, GL8D04M series, GL8D56M series are 1-digit, thin package surface mount type numeric LEDs. (character height: 8.0/10.16/14.22 mm). It is unnecessary to adjust the mounting height because the thickness of each series is the same. They are suited for measuring equipment and various thin type display systems.



GL9D04M

Model Line-up

Type	Character height (mm)	Radiation color Common	[D]	[E]	Outline Dimensions	
			Red	Yellow-green	Page	Figure
Mold type	8.0	Anode	GL9D03M	GL9E03M	180	1
		Cathode	GL8D03M	GL8E03M		
	10.16	Anode	GL9D04M	GL9E04M	180	2
		Cathode	GL8D04M	GL8E04M		
	14.22	Anode	GL9D56M	GL9E56M	180	3
		Cathode	GL8D56M	GL8E56M		

Absolute Maximum Ratings (Figures shown below are values per segment.)

(Ta=25°C)

Model No.	Forward current I _F (mA)	Peak forward current*1 I _{FM} (mA)	Derating factor		Reverse voltage V _R (V)	Operating temperature T _{opr} (°C)	Storage temperature T _{stg} (°C)
			DC (mA/°C)	Pulse (mA/°C)			
GL9E03M/GL8E03M	Yellow-green	15	50	1.91	6.36	-30 to +70	-40 to +80
GL9D03M/GL8D03M	Red	20	50	2.54	6.36		
GL9E04M/GL8E04M	Yellow-green	15	50	1.91	6.36	-30 to +70	-40 to +80
GL9D04M/GL8D04M	Red	20	50	2.54	6.36		
GL9E56M/GL8E56M	Yellow-green	15	50	1.91	6.36	-30 to +70	-40 to +80
GL9D56M/GL8D56M	Red	20	50	2.54	6.36		

*1 Duty ratio=1/10, pulse width=0.1ms

Electro-optical Characteristics (Figures shown below are values per segment.)

(Ta=25°C)

Model No.	Forward current V _F (V)	Luminous intensity		Peak emission wavelength	Spectrum radiation bandwidth		Reverse current		
		I _v (mcd)		λ _p (nm)	Δλ (nm)		I _R (μA)	V _R (V)	
		TYP.	MAX.	TYP.	TYP.	I _F (mA)			
GL9E03M/GL8E03M	Yellow-green	2.0	2.5	2.5	565	30	10	10	4
GL9D03M/GL8D03M	Red	1.85	2.3	2.3	635	35	10	10	4
GL9E04M/GL8E04M	Yellow-green	2.0	2.5	3.0	565	30	10	10	4
GL9D04M/GL8D04M	Red	1.85	2.3	3.0	635	35	10	10	4
GL9E56M/GL8E56M	Yellow-green	2.0	2.5	4.0	565	30	10	10	4
GL9D56M/GL8D56M	Red	1.85	2.3	4.0	635	35	10	10	4

Dichromatic Numeric LED

■ General Description

Sharp's dichromatic numeric LEDs GL9ED08 series, GL8ED100 series are 1-digit large size numeric LEDs(character height: 20.32/25.4mm). They have realized expressive display, changing the radiation color according to display type.

They are suited for measuring equipment, amusement equipment, and various displays.

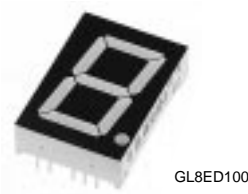

■ Model Line-up

Type	Character height (mm)	Radiation color common	E D		E T		Outline dimensions	
			Yellow-green+Red	Yellow-green+Red(High-luminosity)	Page	Figure		
Mold type	20.32	Anode	GL9ED08		181	8		
	25.40	Anode	GL9ED100	GL9ET100	180	6		
		Cathode	GL8ED100	GL8ET100				

■ Absolute Maximum Ratings (Figures shown below are values per segment.)

(Ta=25°C)

Model No.	Radiation color	Forward current	Peak forward current ^{*1}	Derating factor		Reverse voltage	Operating temperature	Storage temperature
		I _F (mA)	I _{FM} (mA)	DC (mA/°C)	Pulse (mA/°C)			
GL9ED08	Yellow-green	20	50	0.36	0.91	5	-30 to +70	-40 to +80
GL8ED100	Yellow-green	20	50	0.36	0.91	6	-30 to +70	-40 to +80
GL9ED100	Red	20	50	0.36	0.91	6		
GL8ET100	Yellow-green	20	50	0.36	0.91	6	-30 to +70	-40 to +80
GL9ET100	Red(High-luminosity)	20	100	0.36	1.82	6		

*1 Duty ratio=1/10, Pulse width=0.1ms

■ Electro-optical Characteristics (Figures shown below are values per segment.)

(Ta=25°C)

Model No.	Radiation color	Forward current		Luminous intensity	Peak emission wavelength	Spectrum radiation bandwidth	I _F (mA)	Reverse current	
		V _F (V) TYP.	V _F (V) MAX.	I _v (mcd) TYP.	λ _p (nm) TYP.	Δλ(nm) TYP.		I _R (μA) MAX.	V _R (V)
GL9ED08	Yellow-green	2.0	2.5	3.0	565	30	10	10	4
GL8ED100	Yellow-green	4.0	5.0	3.5	565	30	10	10	5
GL9ED100	Red	3.7	5.0	3.5	635	35	10	10	5
GL8ET100	Yellow-green	4.0	5.0	3.5	565	30	10	10	5
GL9ET100	Red(High-luminosity)	3.4	4.4	4.8	660	20	10	10	5

Super-luminosity/High-luminosity Numeric LED

■ Super-luminosity/High-luminosity Numeric LED Figures shown below are values per segment.

(Ta=25°C)

Digit	Type	Character height (mm)	Type of display	Common pins	U (Red)		T (Red)		Outline dimensions		
					Model No.	Luminous intensity (mcd)	Model No.	Luminous intensity (mcd)	Page	Figure	
						TYP.		TYP.			
1-digit	Mold Type	8.0		A			GL9T030	4.0	181	11	
				K			GL8T030	4.0			
		10.16		A			GL9T040	4.25			10
				K			GL8T040	4.25			
		14.12		A			GL9T156	5.25			9
				K			GL8T156	5.25			
		20.32		A			GL9T08	2.2	7		
				K			GL8T08	2.2			
		25.4		A		GL9U100	35.0	GL9T100	9.5	180	5
				K			GL8T100	9.5			
		38.1		A		GL9U15	27.0			4	
		Multi-digits	Mold Type	10.16		A			GL7T201	4.25	182
K							GL6T201	4.25			
8.0				A			GL3T422	1.5	18		
				K			GL3T421	1.5			
7.6				A			GL3T508D	1.5	183	20	
				K			GL3T507D	1.5			

*1 A: Anode common K: Cathode common * Production after order confirmation

* As for current conditions, refer to I_F in electro-optical characteristics.

■ Absolute Maximum Ratings Figures shown below are values per segment.

(Ta=25°C)

Character height (mm)	Radiation color	Forward current I _F (mA)	Peak forward current I _{FM} ^{*1} (mA)	Derating factor (mA/°C)		Reverse voltage V _R (V)	Operating temperature T _{opr.} (°C)	Storage temperature T _{stg.} (°C)
				DC	Pulse			
8.0/10.16/14.12/20.32	T	20	100	0.36	1.82	5	-30 to +70	-40 to +80
25.4, 38.1	U	20	150 ^{*2}	0.36	2.73	6	-30 to +70	-40 to +80
25.4, 38.1	T	20	100	0.36	1.82	5	-30 to +70	-40 to +80

*1 Duty ratio=1/10, Pulse width=0.1ms

*2 U type duty ratio=1/16, pulse width=0.1ms

■ Electro-optical Characteristics Figures shown below are values per segment.

(Ta=25°C)

Character height (mm)	Radiation color	Forward current V _F		Peak emission wavelength λ _p (nm) TYP.	Spectrum radiation bandwidth Δλ(nm) TYP.	I _F (mA)	Reverse current	
		TYP.	MAX				I _R (μA) MAX.	V _R (V)
8.0/10.16/14.12/20.32	T	1.7	2.2	660	20	10	10	4
25.4, 38.1	U	3.5	4.8	660	20	10	100	5
25.4, 38.1	T	3.4	4.4	660	20	10	10	4

Numeric LED

■ 1-digit

Type	Character height (mm)	Type of display	Common pins	Radiation color						Outline dimensions			
				P Red	D Red	S Sunset orange	H Yellow	E Yellow-green	K Green	Page	Figure		
Mold Type	8.0		A	GL9P030	GL9D030	GL9S030	GL9H030	GL9E030	GL9K030	181	11		
			K	GL8P030	GL8D030	GL8S030	GL8H030	GL8E030	GL8K030				
	A		GL9P040	GL9D040	GL9S040	GL9H040	GL9E040	GL9K040	10				
	K		GL8P040	GL8D040	GL8S040	GL8H040	GL8E040	GL8K040					
	14.12		A	GL9P156	GL9D156	GL9S156	GL9H156	GL9E156	GL9K156	180	9		
			K	GL8P156	GL8D156	GL8S156	GL8H156	GL8E156	GL8K156				
	25.4			A		GL9D100	GL9S100	GL9H100	GL9E100			180	5
				K		GL8D100	GL8S100	GL8H100	GL8E100				
Page for ratings/characteristics diagrams				176	177	178	178	179	179				

*1 A: Anode common K: Cathode common

■ Absolute Maximum Ratings(Mold Type) Figures shown below are values per segment.

(Ta=25°C)

Character height (mm)	Radiation color	Forward current I _F (mA)	Peak forward current I _{FM} (mA)	Derating factor (mA/°C)		Reverse voltage V _R (V)	Operating temperature T _{opr.} (°C)	Storage temperature T _{stg.} (°C)
				DC	Pulse			
6.0	P	10	50	0.18	0.91	5	-30 to +70	-40 to +80
6.2		(15) ^{*2}		(0.27)				
7.6	D	20	50	0.36	0.91	5	-30 to +70	-40 to +80
8.0								
8.4	S	20	50	0.36	0.91	5	-30 to +70	-40 to +80
10.16	H	20	50	0.36	0.91	5	-30 to +70	-40 to +80
14.12	E	15	50	0.27	0.91	5	-30 to +70	-40 to +80
20.32 (common)	K	15	50	0.27	0.91	5	-30 to +70	-40 to +80
25.4	D	20	50	0.36	0.91	6	-30 to +70	-40 to +80
	S	20	50	0.36	0.91	6	-30 to +70	-40 to +80
	H	20	50	0.36	0.91	6	-30 to +70	-40 to +80
	E	20	50	0.36	0.91	6	-30 to +70	-40 to +80

*1 Duty ratio=1/10, Pulse width=0.1ms

*2 (): figures for GL8/9P040, GL8/9P056, GL8/9P156, GL6/7P220

■ Absolute Maximum Ratings(Substrate Type) Figures shown below are values per segment.

(Ta=25°C)

Character height (mm)	Radiation color	Forward current I _F (mA)	Peak forward current I _{FM} (mA)	Derating factor (mA/°C)		Reverse voltage V _R (V)	Operating temperature T _{opr.} (°C)	Storage temperature T _{stg.} (°C)
				DC	Pulse			
7.6	P	15	50	0.15	1.11	5	-10 to +60	-20 to +70

*1 Duty ratio=1/10, Pulse width=0.1ms

Numeric LED

Multi-digits

Type	Character height (mm)	Type of display	Common pins	Radiation color					Outline dimensions	
				P Red	D Red	S Sunset orange	H Yellow	E Yellow-green	Page	Figure
Mold Type	6.0		A	GL7P202			GL7H202	GL7E202	183	15
			K	GL6P202				GL6E202		
	10.16		A	GL7P201	GL7D201		GL7H201	GL7E201	183	13
			K	GL6P201	GL6D201			GL6E201		
	14.12		A	GL7P220	GL7D220	GL7S220	GL7H220	GL7E220	181	12
			K		GL6D220	GL6S220	GL6H220			
	8.0		A	GL3P306				GL3E306	182	16
			K	GL3P305	GL3D305			GL3E305		
	6.2		A	GL3P412			GL3H412	GL3E412	182	17
			K	GL3P411				GL3E411		
	8.0		A	GL3P422				GL3E422	182	18
			K	GL3P421						
	8.4		A	GL3P404	GL3D404			GL3E404	183	19
			K	GL3P403	GL3D403			GL3E403		
7.6		A	GL3P508D					183	20	
		K	GL3P507D							
Substrate Type	7.6		A	GL7P208U▲					182	14
Page for ratings/characteristics diagrams				176	177	178	178	179		

*1 A: Anode common K: Cathode common

The model marked with ▲ may not be available in the near future. Contact Sharp sales personnel for details before use.

Electro-optical Characteristics(Mold Type) Figures shown below are values per segment.

(Ta=25°C)

Character height (mm)	Radiation color	Forward voltage V _F (V)		Peak emission wavelength λ _p (nm) TYP.	Spectrum radiation bandwidth Δλ(nm) TYP.	I _F (mA)	Reverse current I _R (μA) MAX.	V _R (V)
		TYP.	MAX.					
6.0	P	1.9	2.5	695	100	5	10	4
6.2	D	1.85	2.3	635	35	10	10	4
7.6	S	1.9	2.5	610	35	10	10	4
8.0	H	1.9	2.5	585	30	10	10	4
8.4	E	2.0	2.5	565	30	10	10	4
10.16	K	2.0	2.5	555	30	10	10	4
25.4	D	3.6	4.6	635	35	10	10	5
	S	3.8	5.0	610	35	10	10	4
	H	3.8	5.0	585	30	10	10	5
	E	4.0	5.0	565	30	10	10	5

Electro-optical Characteristics(Substrate Type) Figures shown below are values per segment.

(Ta=25°C)

Character height (mm)	Radiation color	Forward voltage V _F (V)		Peak emission wavelength λ _p (nm) TYP.	Spectrum radiation bandwidth Δλ(nm) TYP.	I _F (mA)	Reverse current I _R (μA) MAX.	V _R (V)
		TYP.	MAX.					
7.6	P	1.9	2.5	695	100	5	10	4

Numeric LED

■ **Luminous Intensity(Unit:mcd)** Figures shown below are values per segment.

(Ta=25°C)

Type	Digit	Character height (mm)	Radiation color		P	D	S	H	E	K
			Series		Red	Red	Sunset orange	Yellow	Yellow-green	Green
			Anode common	Cathode common	TYP	TYP	TYP	TYP	TYP	TYP
Mold Type	1-digit	8.0	GL9□030	GL8□030	1.0	4.14	1.5	2.6	2.5	1.56
		10.16	GL9□040	GL8□040	0.8	3.0	4.3	2.5	3.0	1.75
		14.12	GL9□156	GL8□156	1.0	4.0	3.9	4.5	3.0	2.1
		25.4	GL9□100	GL8□100		6.38	4.8	4.6	3.5	
	2-digits	6.0	GL7□202	GL6□202	0.3			0.35	1.8	
		10.16	GL7□201	GL6□201	0.8	3.8		4.1	3.5	
		14.12	GL7□220	GL6□220	1.0	4.0	4.5	4.5	3.0	
	3-digits	8.0	GL3□306	GL3□305	1.0	2.80			2.85	
		6.2	GL3□412	GL3□411	0.25			0.6	0.7	
	4-digits	8.0	GL3□422	GL3□421	0.66		1.25		2.2	
		8.4	GL3□404	GL3□403	0.3	0.8			2.0	
		7.6	GL3□508D	GL3□507D	0.3					
	Substrate Type	2-digit	7.6	GL7□208U▲		0.2				

* As for current conditions, refer to I_F in electro-optical characteristics

The model marked with ▲ may not be available in the near future. Contact Sharp sales personnel for details before use.

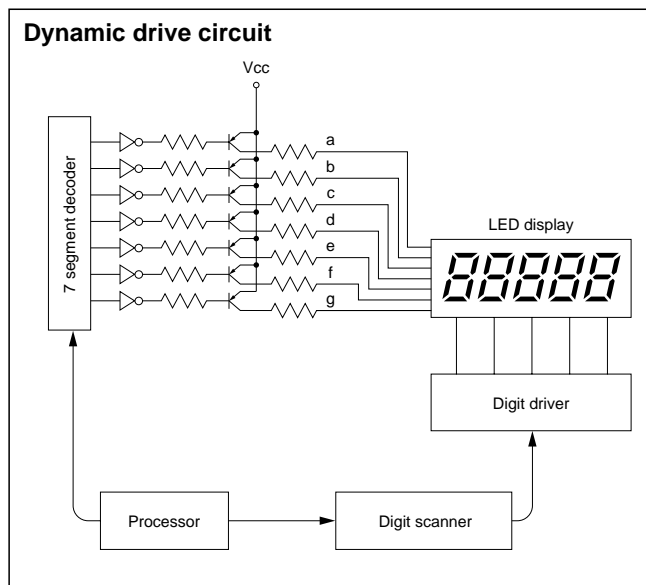
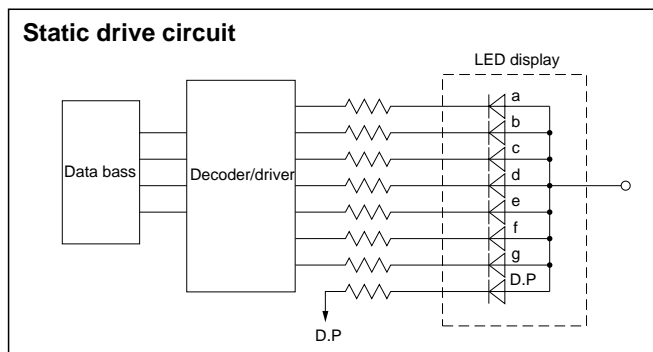

Numeric LED

Numeric LED Characteristics Diagrams

P series

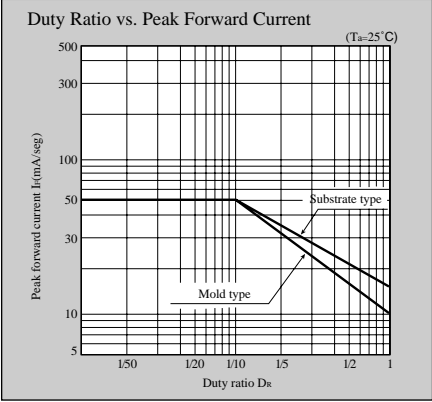
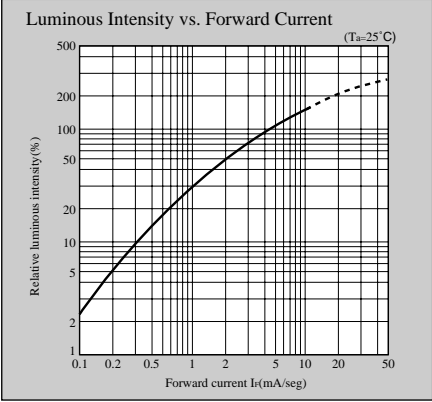
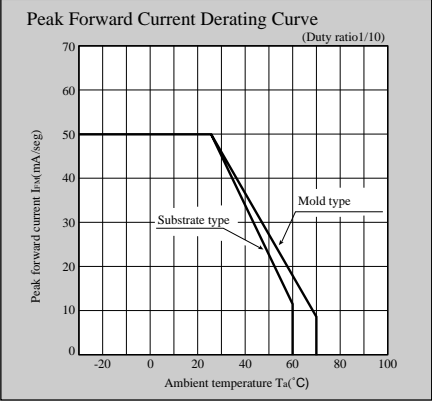
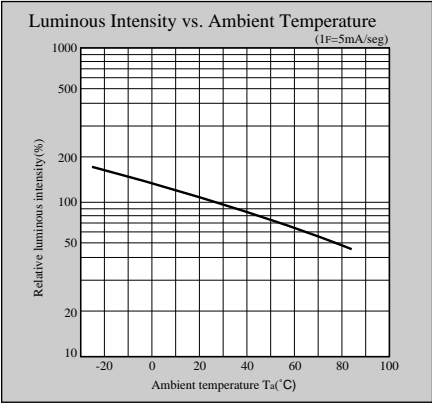
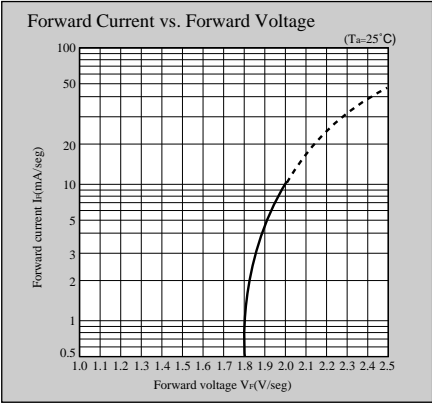
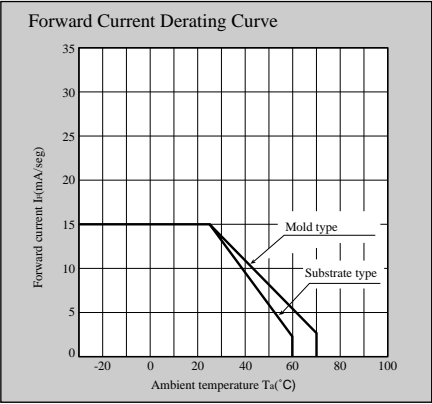

U series

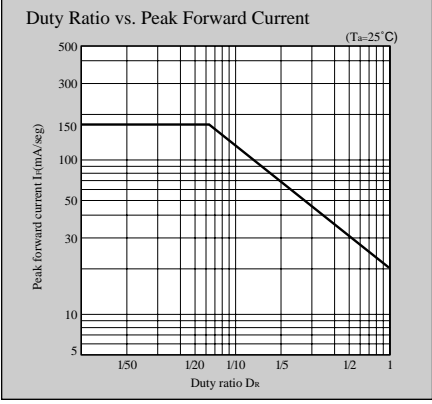
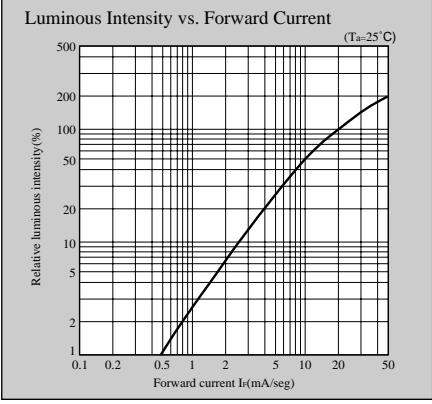
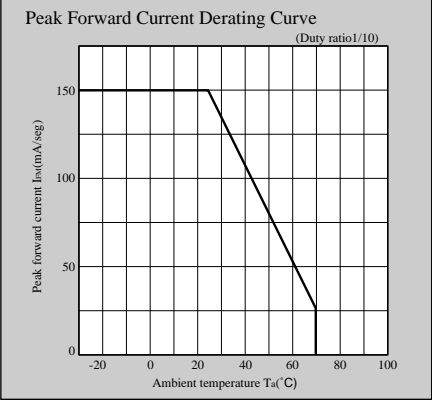
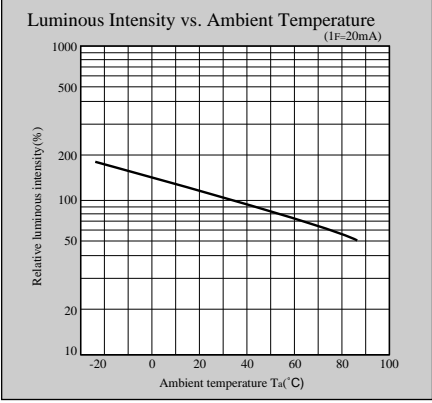
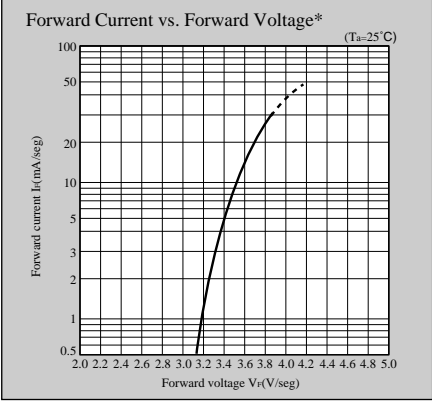
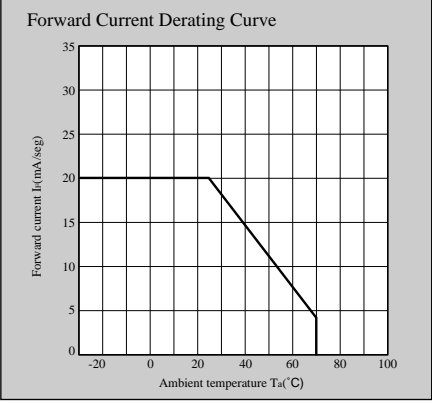

* In case of 25.4/38.1mm: value per 1segment 1chip

Numeric LED Characteristics Diagrams

T series

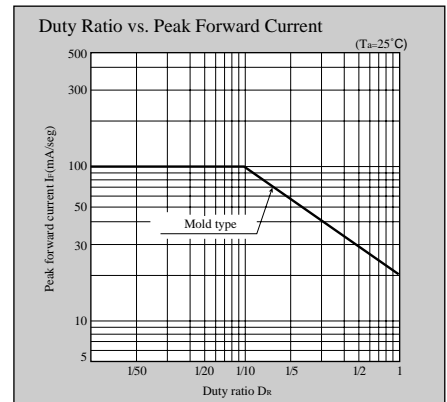
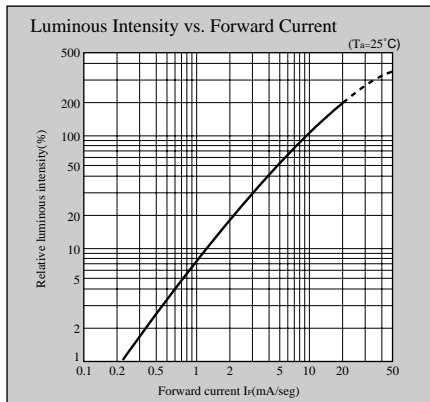
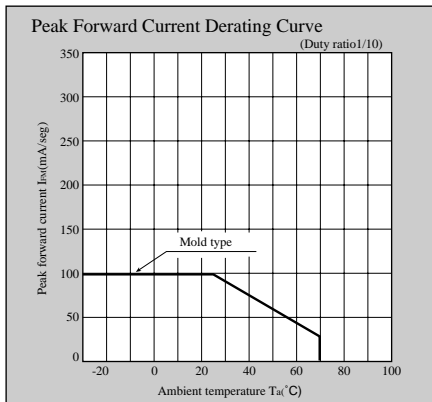
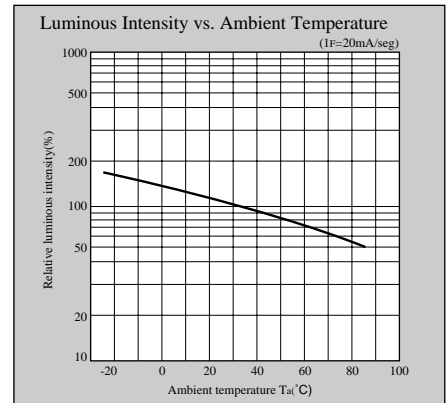
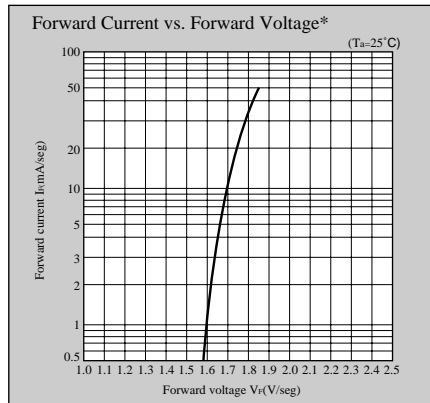
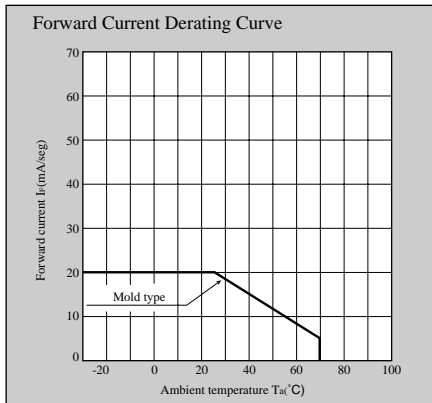

* In case of 25.4mm: value per 1segment 1chip

D series

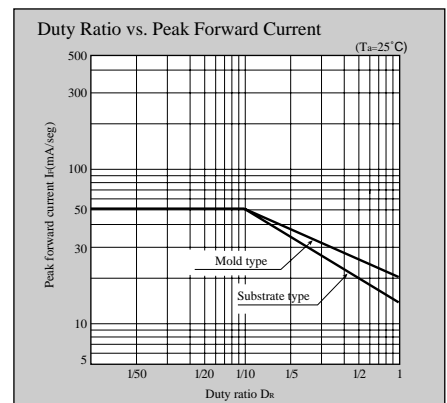
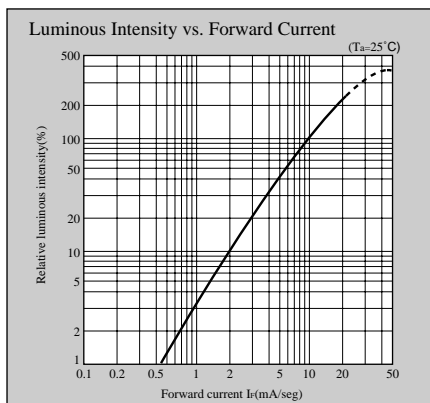
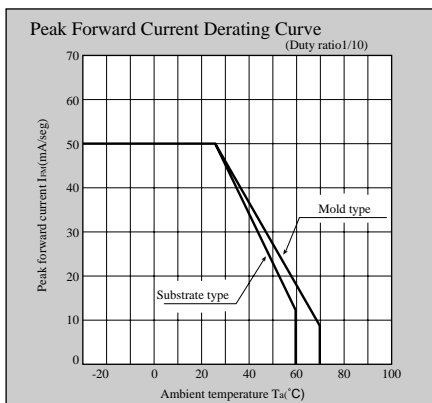
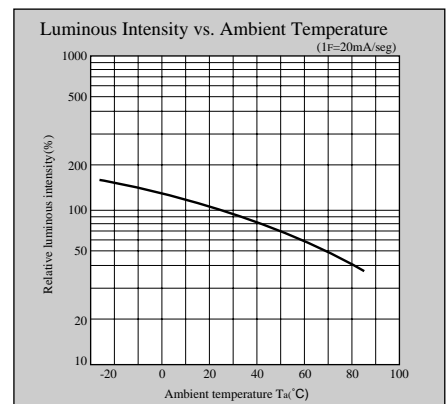
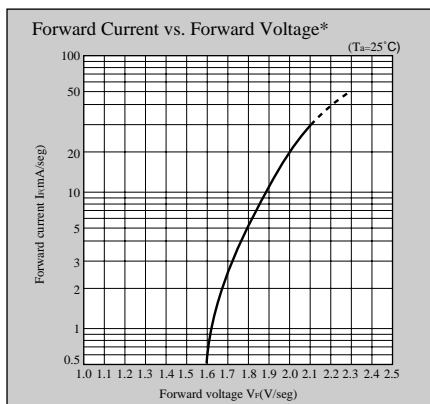
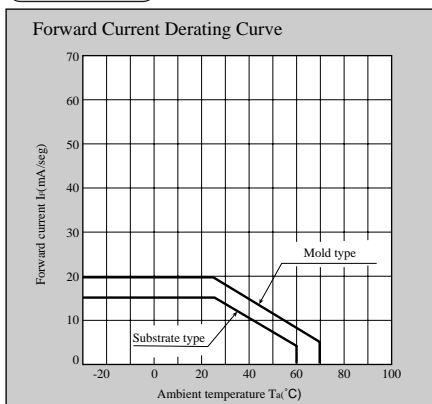

* In case of 25.4mm: value per 1segment 1chip

Numeric LED Characteristics Diagrams

S series

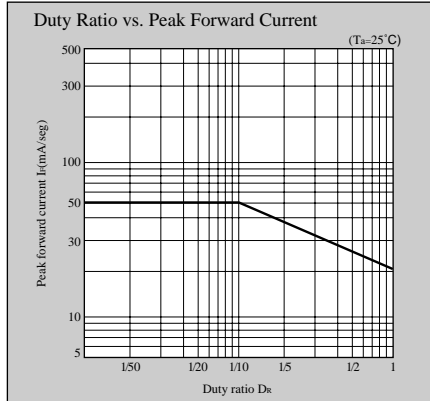
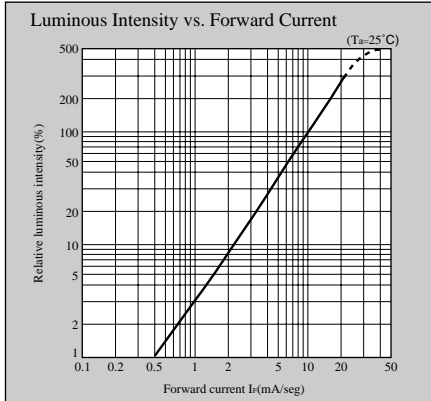
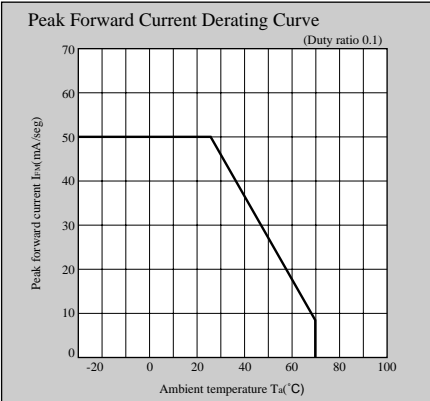
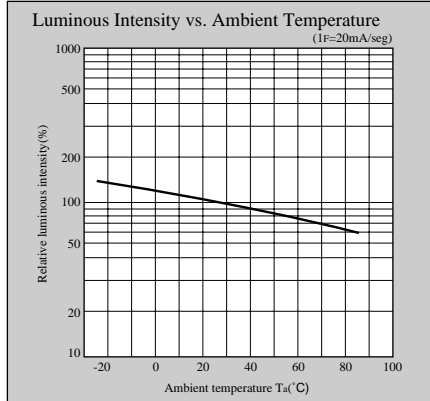
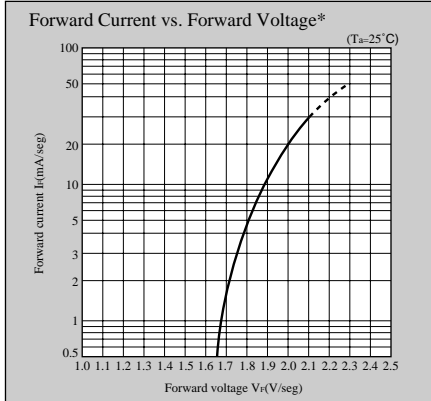
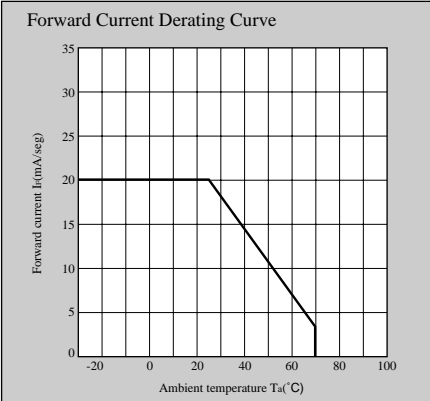

* In case of 25.4mm: value per 1segment 1chip

H series

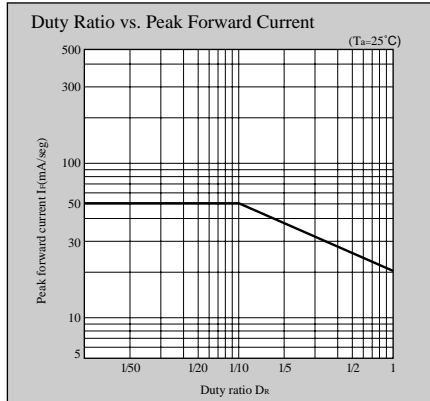
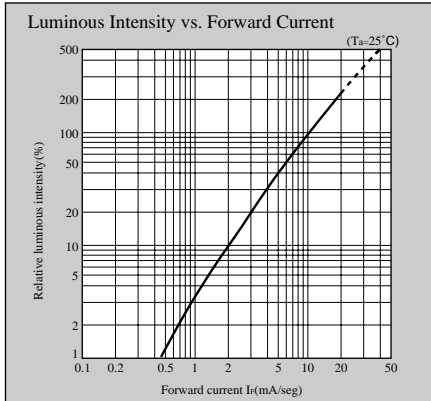
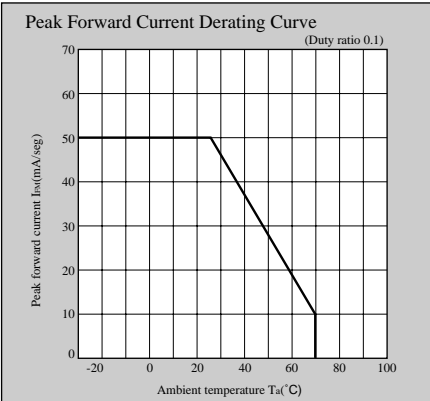
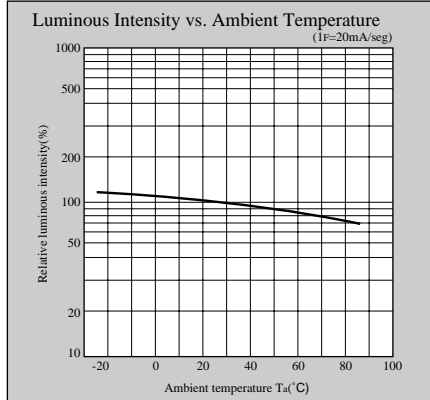
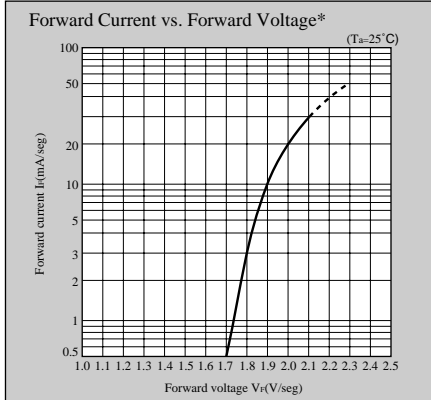
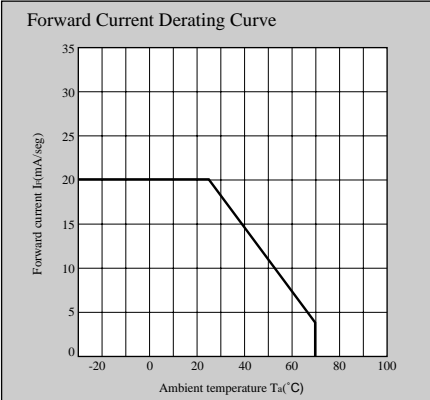

* In case of 25.4mm: value per 1segment 1chip

Numeric LED Characteristics Diagrams

E series

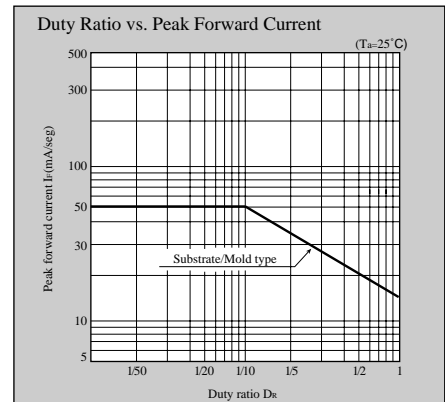
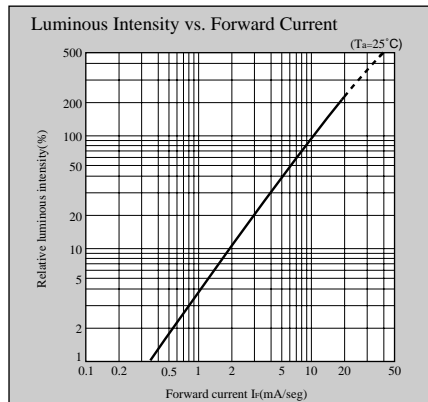
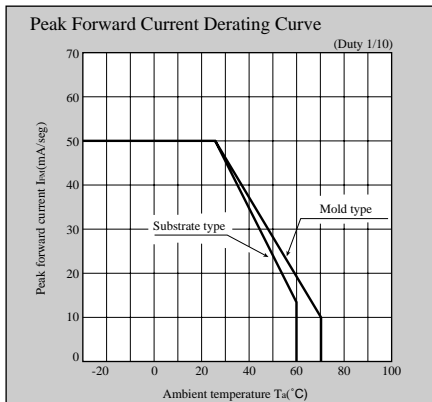
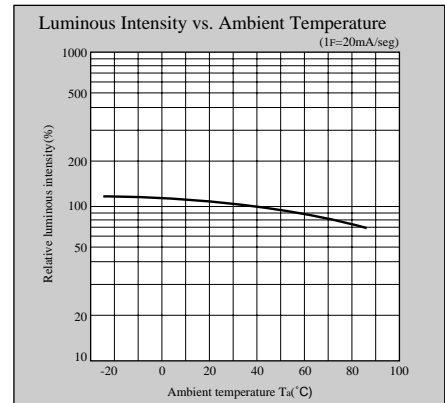
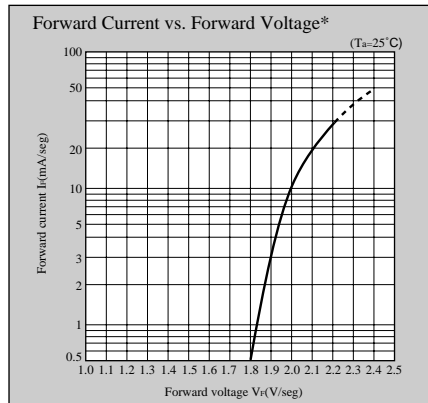
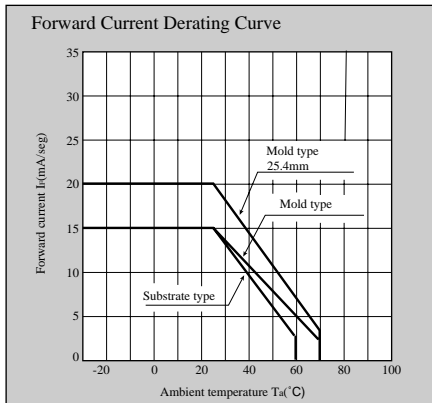

* In case of 25.4mm: value per 1segment 1chip

K series

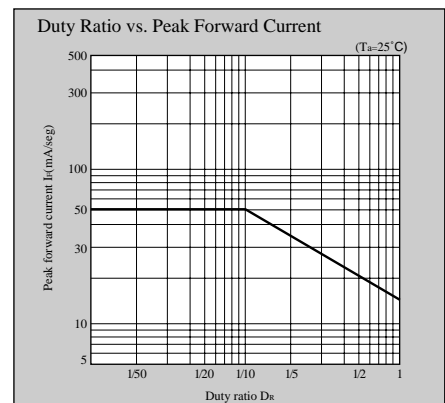
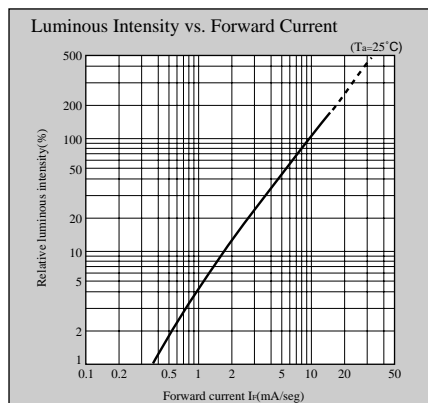
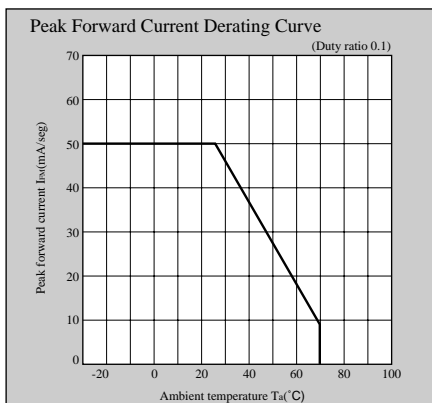
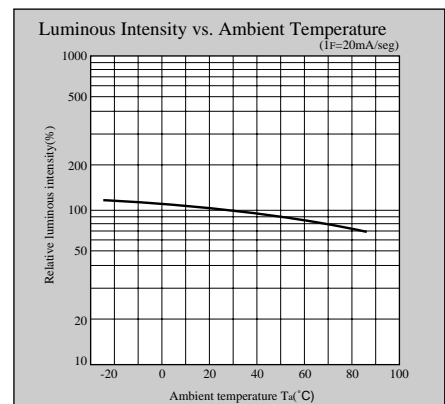
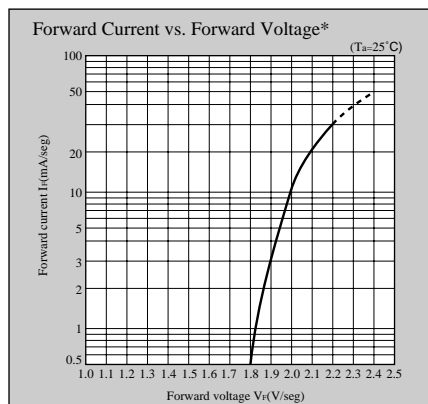
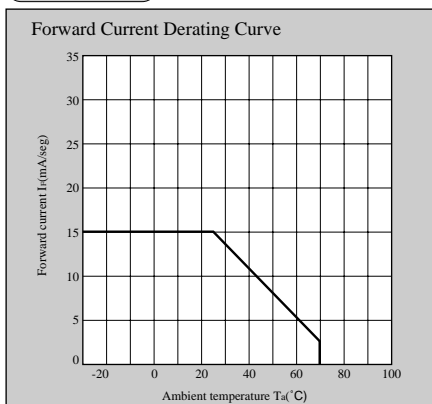

Numeric LED Outline Dimensions(Unit:mm)

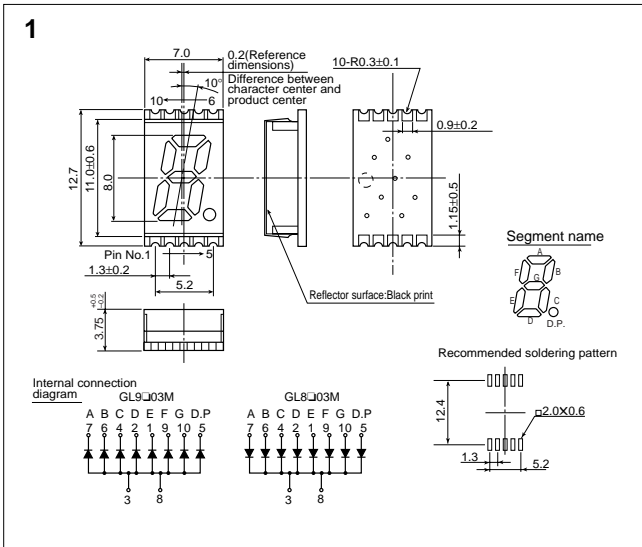

GL9□03M Series GL8□03M Series

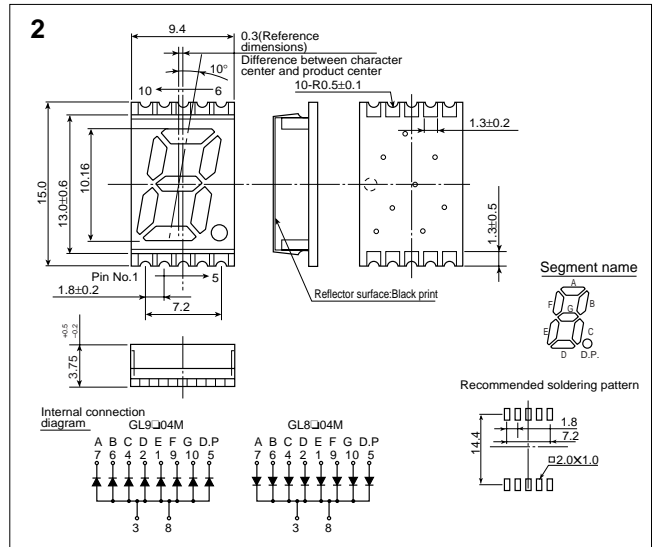

GL9□04M Series GL8□04M Series

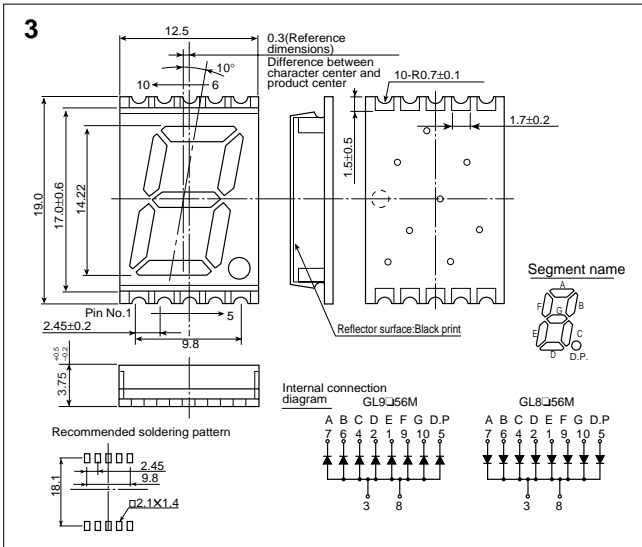

GL9□56M Series GL8□56M Series

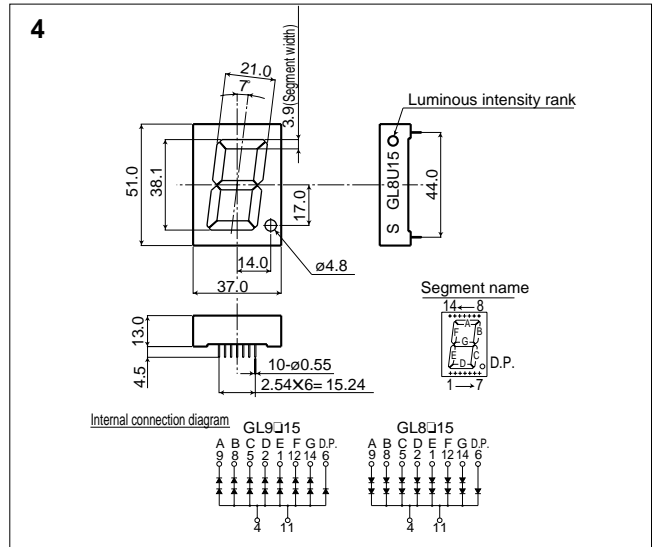

GL9□15 Series GL8□15 Series

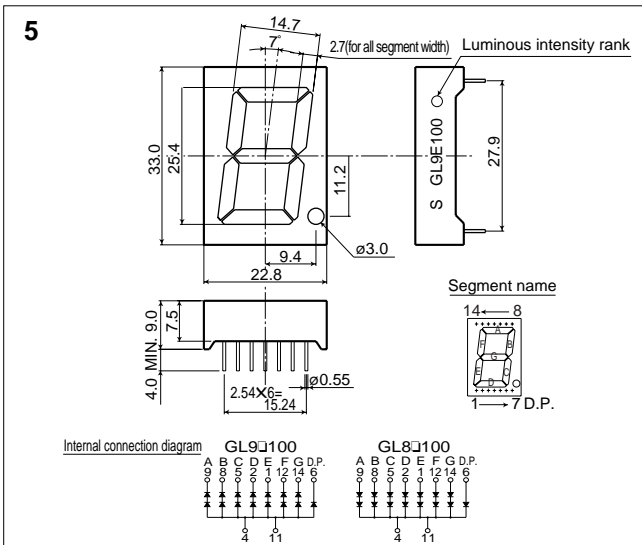

GL9□100 Series GL8□100 Series

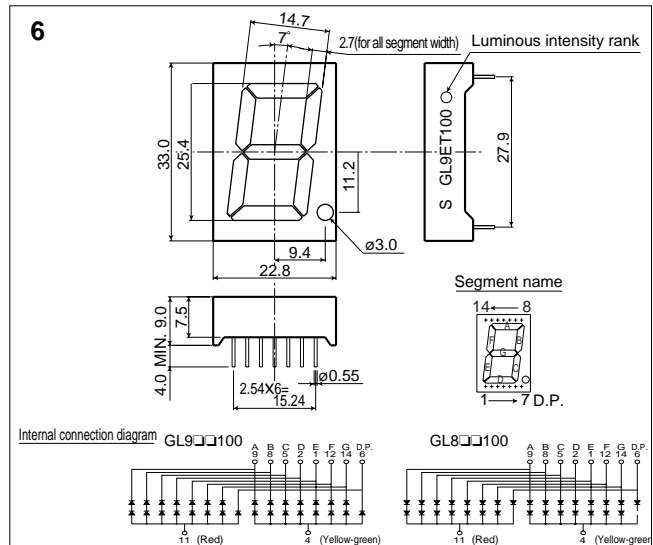

GL9□100 Series GL8□100 Series

Numeric LED Outline Dimensions (Unit:mm)

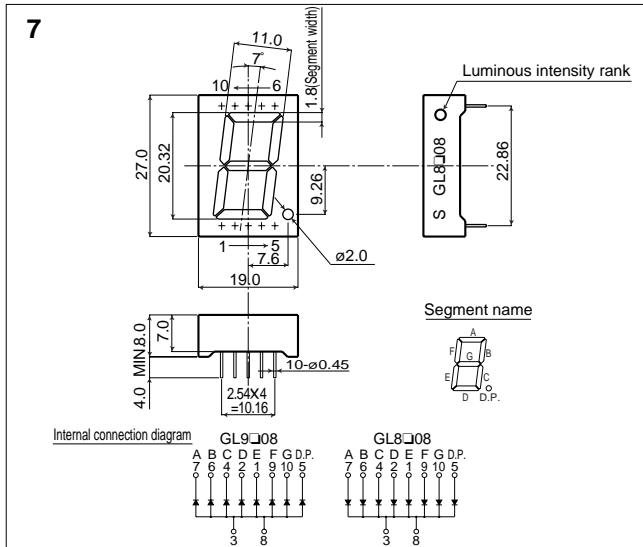

GL9□08 Series GL8□08 Series

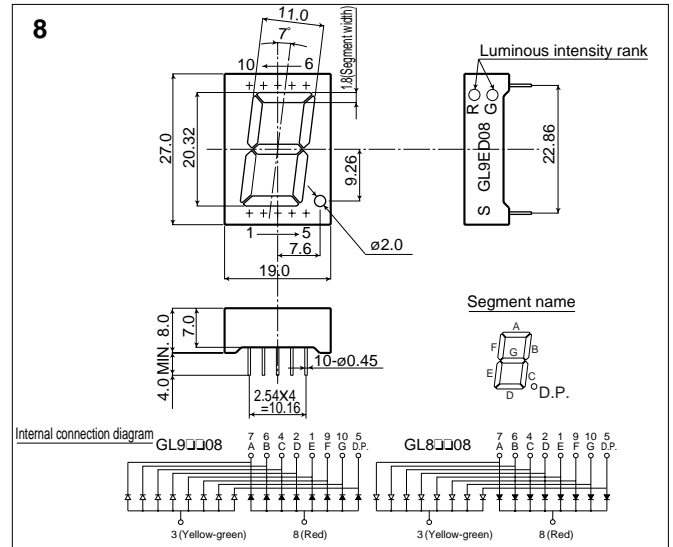

GL9□□08 Series GL8□□08 Series

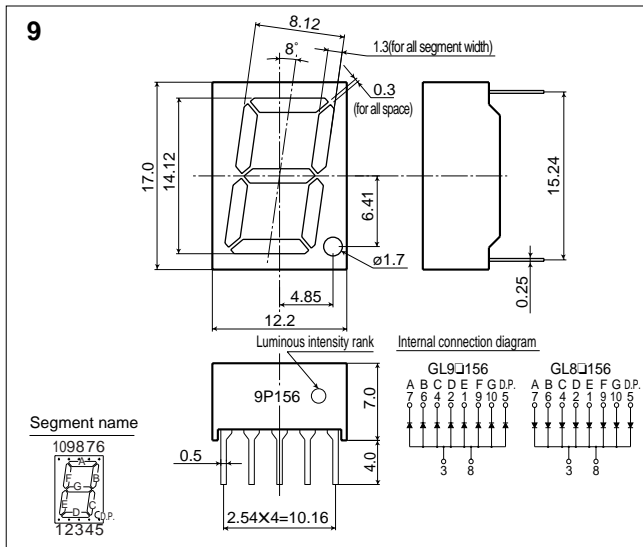

GL9□156 Series GL8□156 Series

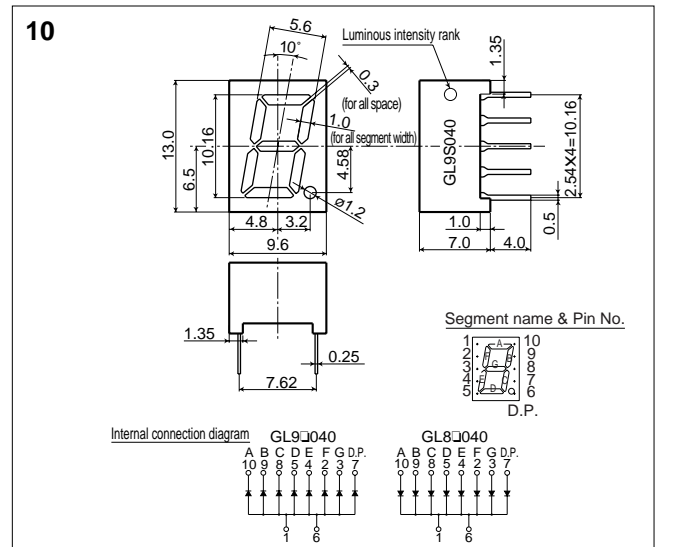

GL9□040 Series GL8□040 Series

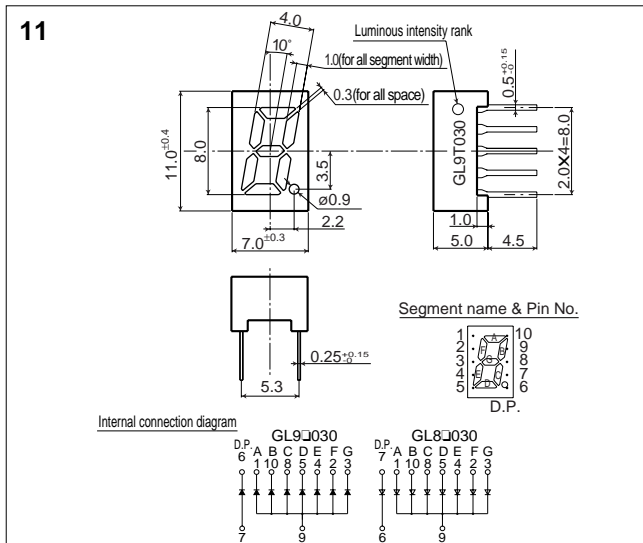

GL9□030 Series GL8□030 Series

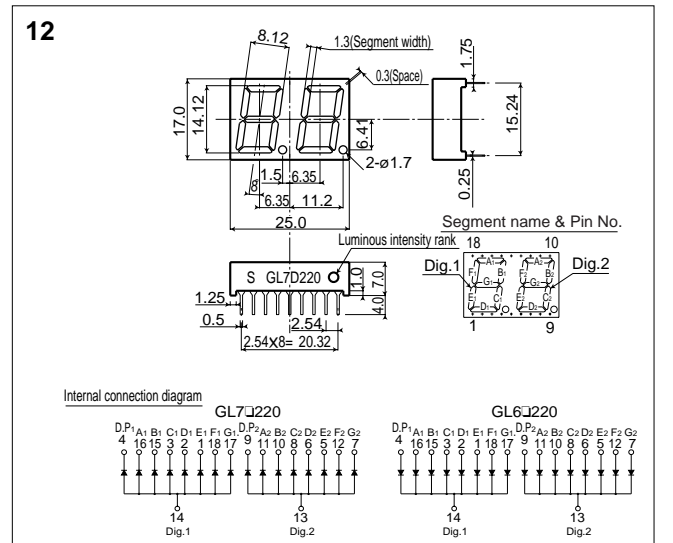

GL7□220 Series GL6□220 Series

Numeric LED Outline Dimensions(Unit:mm)

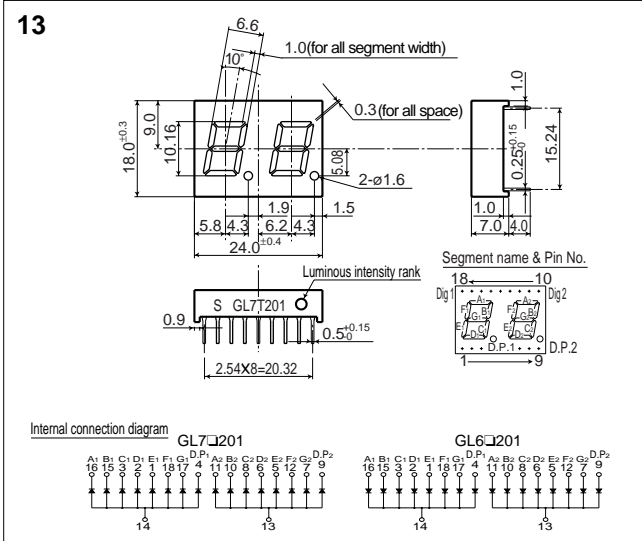

GL7□201 Series GL6□201 Series

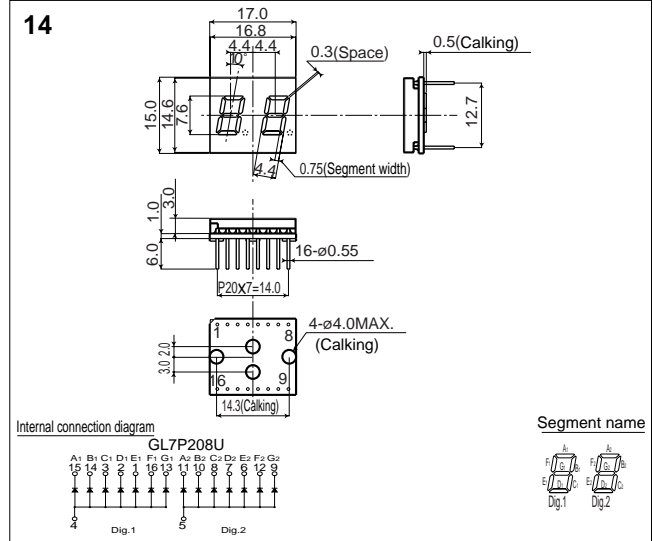

GL7P208U Series▲

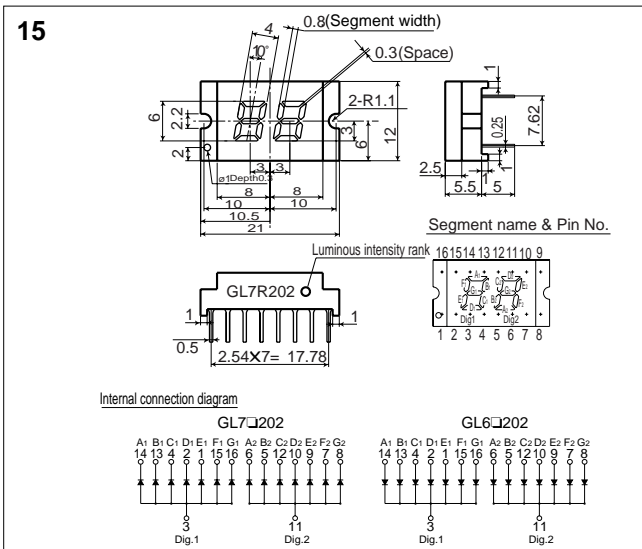

GL7□202 Series GL6□202 Series

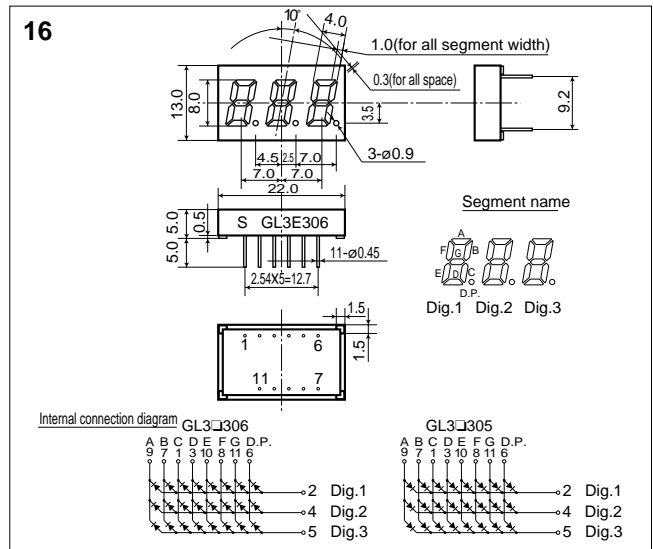

GL3□306 Series GL3□305 Series

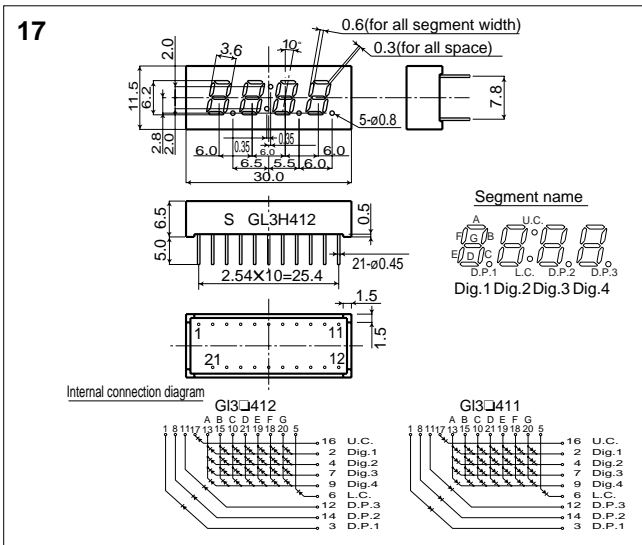

GL3□412 Series GL3□411 Series

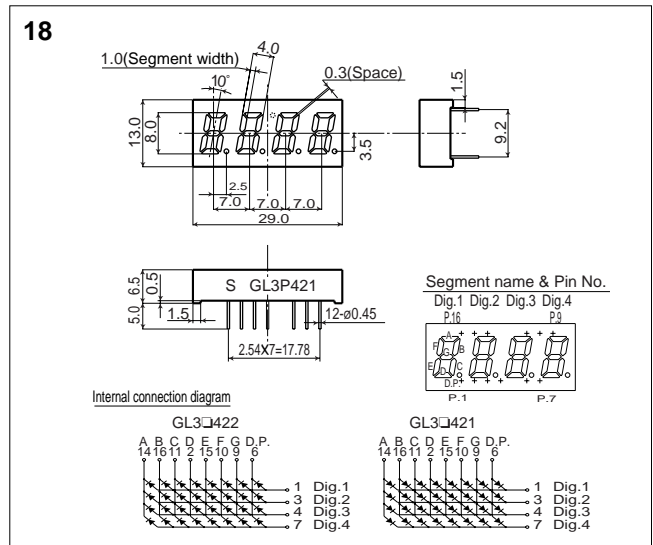

GL3□422 Series GL3□421 Series

The models marked with ▲ may not be available in the near future. Contact Sharp sales personnel for details before use.

Numeric LED Outline Dimensions(Unit:mm)

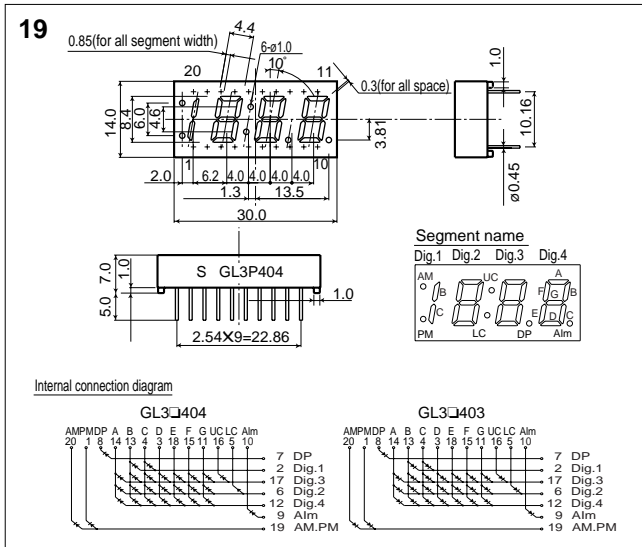

GL3□404 Series GL3□403 Series

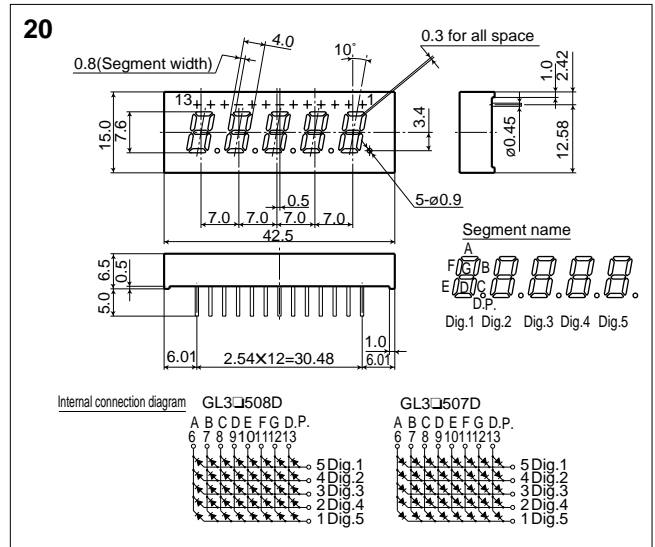

GL3□508D Series GL3□507D Series

NOTICE

- The circuit application examples in this publication are provided to explain representative applications of SHARP devices and are not intended to guarantee any circuit design or license any intellectual property rights. SHARP takes no responsibility for any problems related to any intellectual property right of a third party resulting from the use of SHARP's devices.
- Contact SHARP in order to obtain the latest device specification sheets before using any SHARP device. SHARP reserves the right to make changes in the specifications, characteristics, data, materials, structure, and other contents described herein at any time without notice in order to improve design or reliability. Manufacturing locations are also subject to change without notice.
- Observe the following points when using any devices in this publication. SHARP takes no responsibility for damage caused by improper use of the devices which does not meet the conditions and absolute maximum ratings to be used specified in the relevant specification sheet nor meet the following conditions:
 - (i) The devices in this publication are designed for use in general electronic equipment designs such as:
 - Personal computers
 - Office automation equipment
 - Telecommunication equipment [terminal]
 - Test and measurement equipment
 - Industrial control
 - Audio visual equipment
 - Consumer electronics
 - (ii) Measures such as fail-safe function and redundant design should be taken to ensure reliability and safety when SHARP devices are used for or in connection with equipment that requires higher reliability such as:
 - Transportation control and safety equipment (i.e., aircraft, trains, automobiles, etc.)
 - Traffic signals
 - Gas leakage sensor breakers
 - Alarm equipment
 - Various safety devices, etc.
 - (iii) SHARP devices shall not be used for or in connection with equipment that requires an extremely high level of reliability and safety such as:
 - Space applications
 - Telecommunication equipment [trunk lines]
 - Nuclear power control equipment
 - Medical and other life support equipment (e.g., scuba).
- Contact a SHARP representative in advance when intending to use SHARP devices for any "specific" applications other than those recommended by SHARP or when it is unclear which category mentioned above controls the intended use.
- If the SHARP devices listed in this publication fall within the scope of strategic products described in the Foreign Exchange and Foreign Trade Control Law of Japan, it is necessary to obtain approval to export such SHARP devices.
- This publication is the proprietary product of SHARP and is copyrighted, with all rights reserved. Under the copyright laws, no part of this publication may be reproduced or transmitted in any form or by any means, electronic or mechanical, for any purpose, in whole or in part, without the express written permission of SHARP. Express written permission is also required before any use of this publication may be made by a third party.
- Contact and consult with a SHARP representative if there are any questions about the contents of this publication.