



Micro Commercial Components

Micro Commercial Components
 20736 Marilla Street Chatsworth
 CA 91311
 Phone: (818) 701-4933
 Fax: (818) 701-4939

SMBSAC5.0 THRU SMBSAC50

Low Capacitance Transient Voltage Suppressors 5 to 50 Volts 500Watt

Features

- For surface mount applications in order to optimize board space
- Excellent clamping capability
- Fast response time: typical less than 1.0ps from 0 volts to V_{BR} minimum
- Ideal for data line applications
- UL Recognized File # E222849

Mechanical Data

- Case Material: Molded Plastic. UL Flammability Classification Rating 94V-0
- Terminals: solderable per MIL-STD-750, Method 2026
- The band denotes TVS cathode
- Maximum soldering temperature: 260°C for 10 seconds

Maximum Ratings @ 25°C Unless Otherwise Specified

Peak Pulse Current on 10/1000us waveform	I_{PP}	See Table 1	Note: 1
Peak Pulse Power Dissipation	P_{PP}	500W	Note: 1, 2
Steady State Power Dissipation T_L= 75°C With at lead lengths 0.375"(9.5mm)	P_D	3	Watt
Operation and Storage Temperature Range	T_J, T_{STG}	-55°C to +175°C	

NOTES:

1. Non-repetitive current pulse, per Fig.3 and derated above T_A=25°C per Fig.2.
2. Mounted on 5.0mm² copper pads to each terminal.

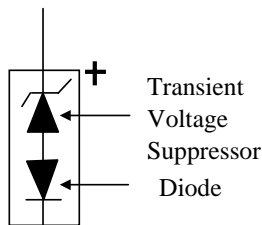

Schematic Diagram

DO-214AA (SMB) (LEAD FRAME)

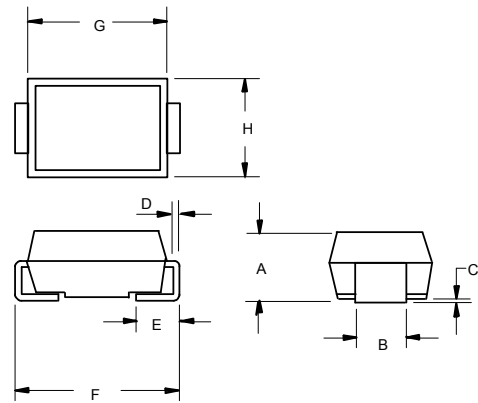

DIM	DIMENSIONS				NOTE
	INCHES		MM		
	MIN	MAX	MIN	MAX	
A	.083	.096	2.13	2.44	
B	.075	.086	1.91	2.20	
C	.002	.008	0.051	0.203	
D	.006	.012	0.152	0.305	
E	.030	.060	0.76	1.52	
F	.200	.220	5.08	5.59	
G	.160	.185	4.06	4.70	
H	.130	.155	3.30	3.94	

**SUGGESTED SOLDER
PAD LAYOUT**

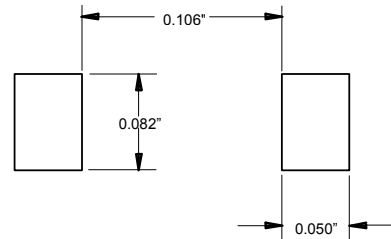

SMBSAC 5.0THRU SMBSAC50

MCC PART NUMBERS	Marking Code	STAND-OFF VOLTAGE V_{WM} (VOLTS)	MINIMUM BREAKDOWN VOLTAGE AT $I_T=1.0mA$ $V(BR)$ (VOLTS)	MAXIMUM REVERSE LEAKAGE AT V_{WM} $I_R(\mu A)$	MAXIMUM CLAMPING VOLTAGE AT $I_{pp}=5.0A$ V_C (V)	MAXIMUM PEAK PULSE CURRENT PER FIG.3 I_{pp} (AMPS)	MAXIMUM JUNCTION CAPACITANCE AT 0 VOLTS (pF)	WORKING INVERSE BLOCKING VOLTAGE V_{WIB} (VOLTS)	INVERSE BLOCKING LEAKAGE CURRENT V_{WIB} IIB(mA)	PEAK INVERSE BLOCKING VOLTAGE V_{PIB} (VOLTS)
SMBSAC5.0	SKE	5.0	7.6	300	10.0	44.0	45	75	1.0	100
SMBSAC6.0	SKG	6.0	7.9	300	11.2	41.0	45	75	1.0	100
SMBSAC7.0	SKM	7.0	8.3	300	12.6	38.0	45	75	1.0	100
SMBSAC8.0	SKR	8.0	8.9	100	13.4	36.0	45	75	1.0	100
SMBSAC8.5	SKT	8.5	9.44	50	14.0	34.0	45	75	1.0	100
SMBSAC10	SKX	10.0	11.10	5	16.3	29.0	45	75	1.0	100
SMBSAC12	SLE	12.0	13.30	5	19.0	25.0	45	75	1.0	100
SMBSAC15	SLM	15.0	16.70	5	23.6	20.0	45	75	1.0	100
SMBSAC18	SLT	18.0	20.00	5	28.8	15.0	45	75	1.0	100
SMBSAC22	SLX	22.0	24.40	5	35.4	14.0	45	75	1.0	100
SMBSAC26	SME	26.0	28.90	5	42.3	11.1	45	75	1.0	100
SMBSAC30	SMK	30.0	33.30	5	48.6	10.0	45	75	1.0	100
SMBSAC36	SMP	36.0	40.00	5	60.0	8.6	45	75	1.0	100
SMBSAC45	SMV	45.0	50.00	5	77.0	6.8	45	150	1.0	200
SMBSAC50	SMZ	50.0	55.50	5	88.0	5.8	45	150	1.0	200

Electrical Ratings and Characteristic Curves ($T_A=25^\circ\text{C}$ unless otherwise specified)

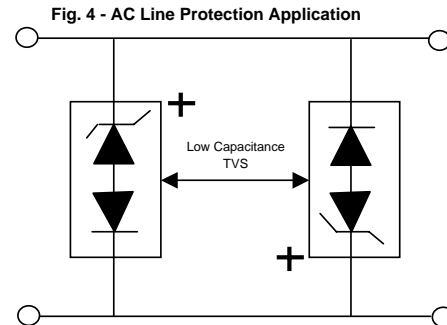
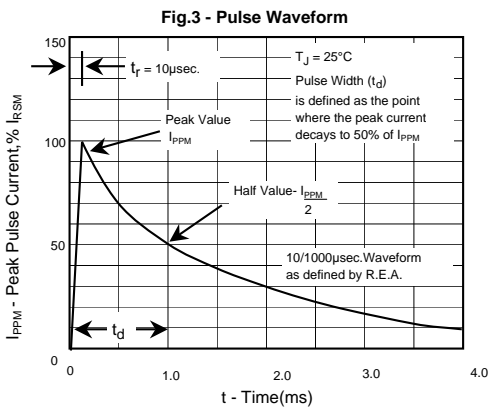
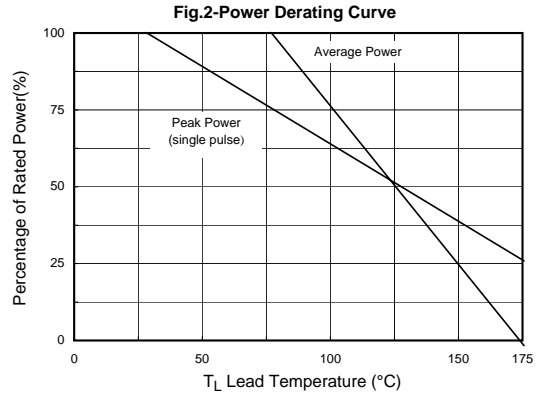
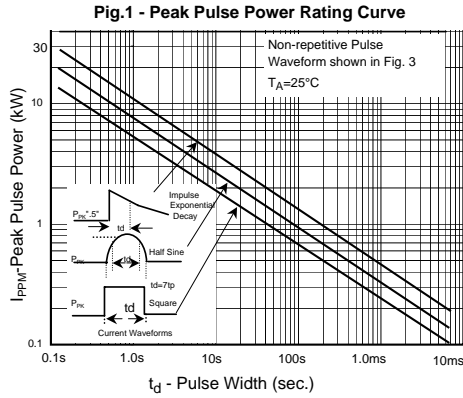

Application Note: Device must be used with two units in parallel, opposite in polarity as shown in circuit for AC signal line protection.



Micro Commercial Components™

*****IMPORTANT NOTICE*****

Micro Commercial Components Corp. reserves the right to make changes without further notice to any product herein to make corrections, modifications, enhancements, improvements, or other changes. *Micro Commercial Components Corp.* does not assume any liability arising out of the application or use of any product described herein; neither does it convey any license under its patent rights, nor the rights of others. The user of products in such applications shall assume all risks of such use and will agree to hold *Micro Commercial Components Corp.* and all the companies whose products are represented on our website, harmless against all damages.

*****APPLICATIONS DISCLAIMER*****

Products offer by *Micro Commercial Components Corp.* are not intended for use in Medical, Aerospace or Military Applications.

www.mccsemi.com