

**Silicon Switching Diode**

- For high-speed switching applications

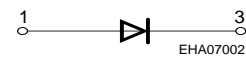
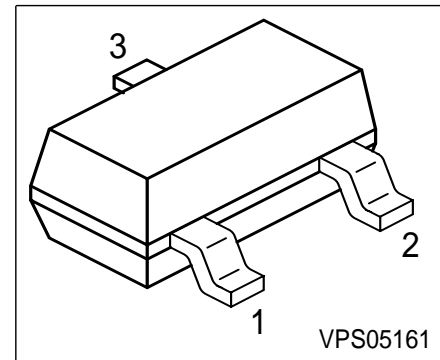

Type	Marking	Pin Configuration			Package
BAR74	JBs	1 = A	2 = n.c.	3 = C	SOT23

**Maximum Ratings**

Parameter	Symbol	Value	Unit
Diode reverse voltage	$V_R$	50	V
Peak reverse voltage	$V_{RM}$	50	
Forward current	$I_F$	250	mA
Surge forward current, $t = 1 \mu s$	$I_{FS}$	4.5	A
Total power dissipation, $T_S = 54 \text{ }^\circ\text{C}$	$P_{tot}$	370	mW
Junction temperature	$T_j$	150	$^\circ\text{C}$
Storage temperature	$T_{stg}$	-65 ... 150	

**Thermal Resistance**

Junction - soldering point <sup>1)</sup>	$R_{thJS}$	$\leq 260$	K/W
--	------------	------------	-----

<sup>1)</sup>For calculation of  $R_{thJA}$  please refer to Application Note Thermal Resistance

**Electrical Characteristics** at  $T_A = 25^\circ\text{C}$ , unless otherwise specified.

Parameter	Symbol	Values			Unit
		min.	typ.	max.	
<b>DC characteristics</b>					
Breakdown voltage $I_{(BR)} = 100 \mu\text{A}$	$V_{(BR)}$	50	-	-	V
Forward voltage $I_F = 100 \text{ mA}$	$V_F$	-	-	1	
Reverse current $V_R = 50 \text{ V}$	$I_R$	-	-	0.1	$\mu\text{A}$
Reverse current $V_R = 50 \text{ V}, T_A = 150^\circ\text{C}$	$I_R$	-	-	100	
<b>AC characteristics</b>					
Diode capacitance $V_R = 0 \text{ V}, f = 20 \text{ MHz}$	$C_D$	-	-	2	pF
Reverse recovery time $I_F = 10 \text{ mA}, I_R = 10 \text{ mA}, R_L = 100 \Omega$ , measured at $I_R = 1 \text{ mA}$	$t_{rr}$	-	-	4	ns

**Test circuit for reverse recovery time**

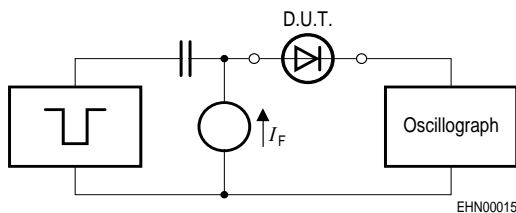

Pulse generator:  $t_p = 100\text{ns}$ ,  $D = 0.05$ ,  
 $t_f = 0.6\text{ns}$ ,  $R_f = 50\Omega$

Oscilloscope:  $R = 50\Omega$ ,  $t_r = 0.35\text{ns}$ ,  
 $C \leq 1\text{pF}$

Forward current  $I_F = f(T_S)$

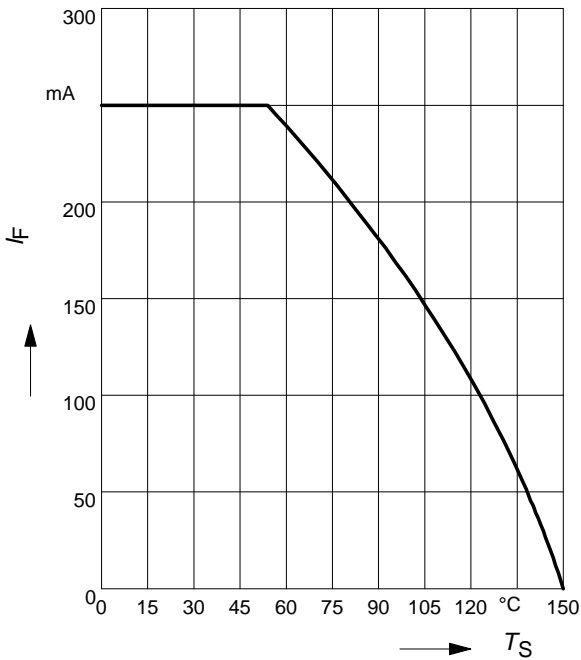

Reverse current  $I_R = f(T_A)$

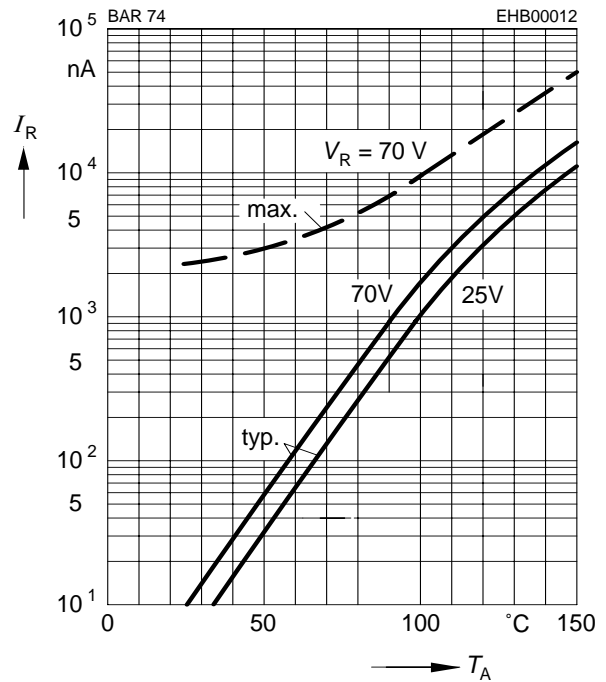

Forward current  $I_F = f(V_F)$

$T_A = 25^\circ\text{C}$

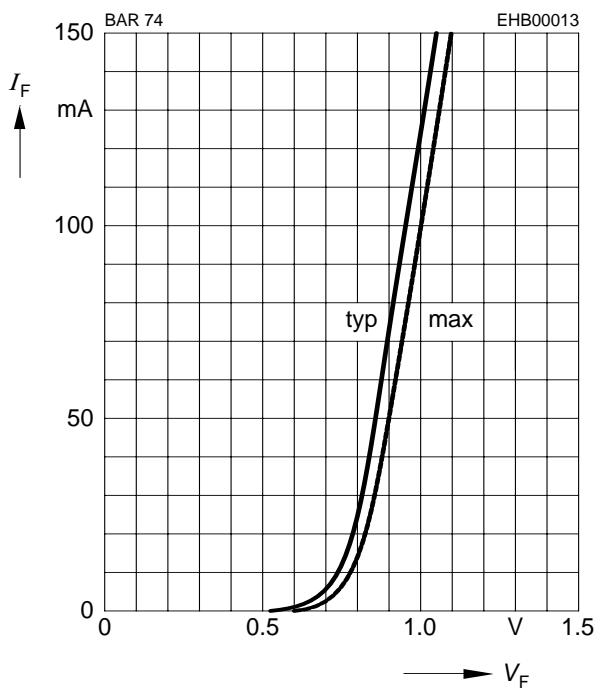

Peak forward current  $I_{FM} = f(t_p)$

$T_A = 25^\circ\text{C}$

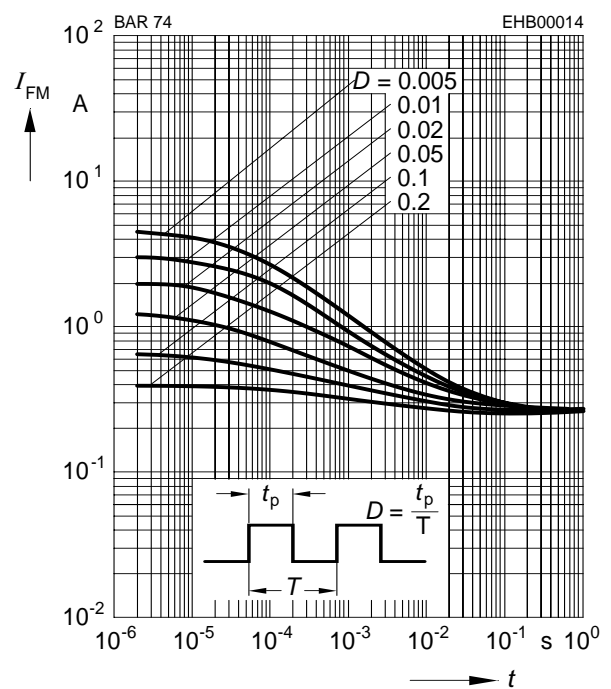

**Forward voltage  $V_F = f(T_A)$**

