

SHINDENGEN

Schottky Rectifiers (SBD)

Single

D5S6M

60V 5A

FEATURES

Tj150
 P_{RRSM} avalanche guaranteed
 Fully Isolated Molding

APPLICATION

Switching power supply
 DC/DC converter
 Home Appliances, Office Equipment
 Telecommunication

OUTLINE DIMENSIONS

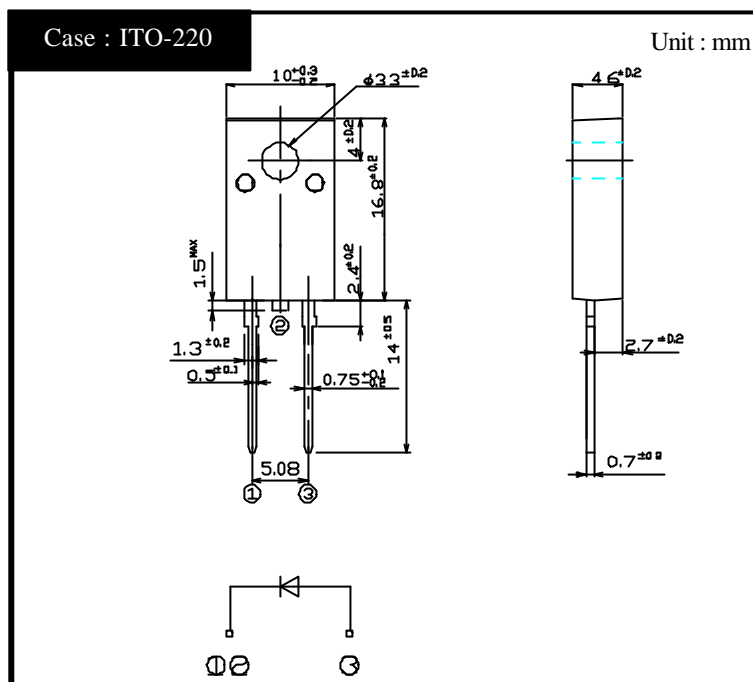

RATINGS

Absolute Maximum Ratings (If not specified T_c=25)

Item	Symbol	Conditions	Ratings	Unit
Storage Temperature	T _{stg}		-55 ~ 150	
Operating Junction Temperature	T _j		150	
Maximum Reverse Voltage	V _{RM}		60	V
Repetitive Peak Surge Reverse Voltage	V _{RRSM}	Pulse width 0.5ms, duty 1/40	65	V
Average Rectified Forward Current	I _O	50Hz sine wave, R-load, T _c =130	5	A
Peak Surge Forward Current	I _{FSM}	50Hz sine wave, Non-repetitive 1 cycle peak value, T _j =125	100	A
Repetitive Peak Surge Reverse Power	P _{RRSM}	Pulse width 10 μs, T _j = 25	330	W
Dielectric Strength	V _{dis}	Terminals to case, AC 1 minute	1.5	kV
Mounting Torque	TOR	(Recommended torque 0.3N·m)	0.5	N·m

Electrical Characteristics (If not specified T_c=25)

Item	Symbol	Conditions	Ratings	Unit
Forward Voltage	V _F	I _F =5A, Pulse measurement	Max.0.58	V
Reverse Current	I _R	V _R =V _{RM} , Pulse measurement	Max. 4.5	mA
Junction Capacitance	C _j	f=1MHz, V _R =10V	Typ.260	pF
Thermal Resistance	j _c	junction to case	Max.4.5	/W
	c _f	case to heatsink	Max.1.5	

D5S6M

Forward Voltage

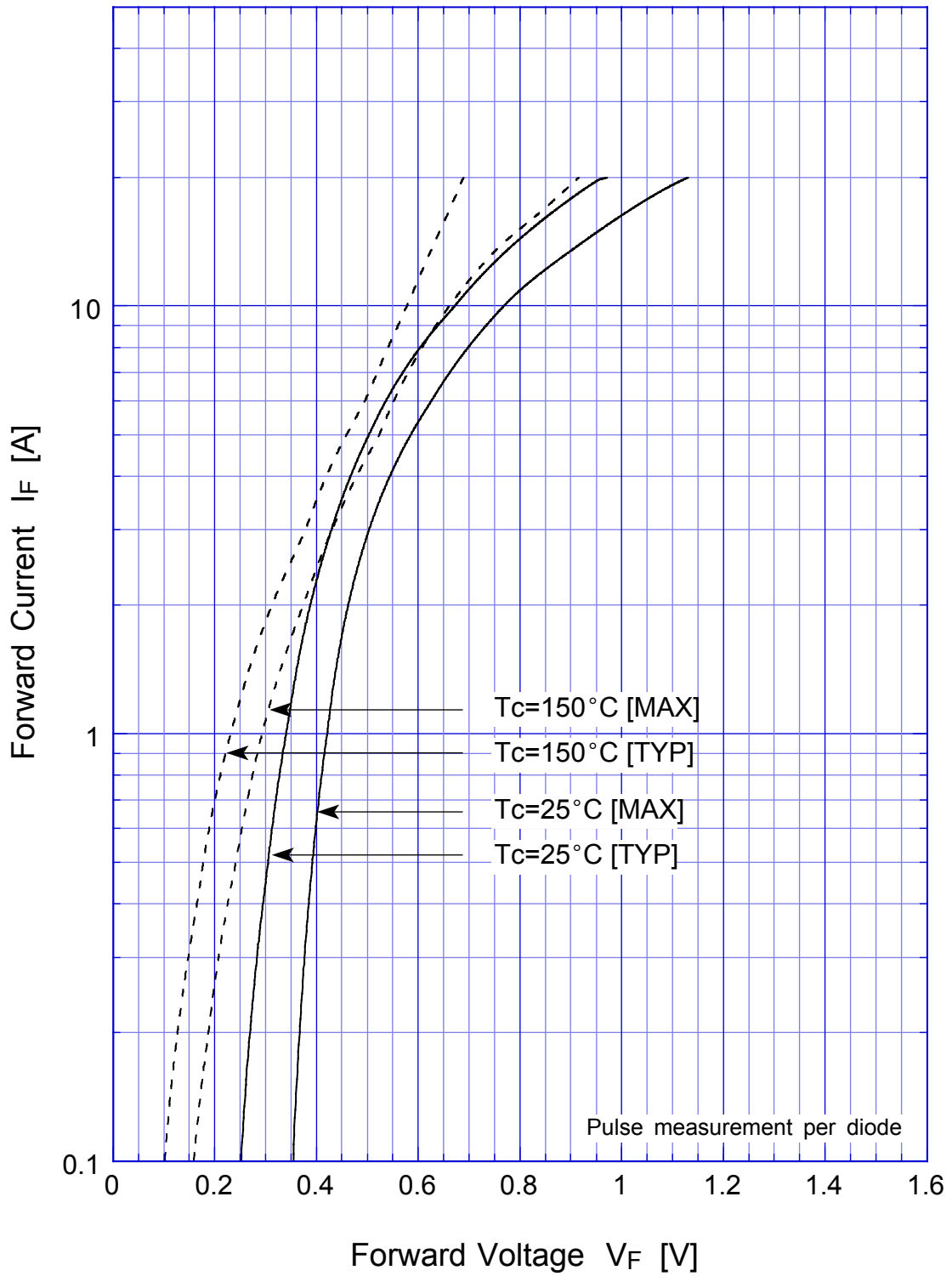

D5S6M

Junction Capacitance

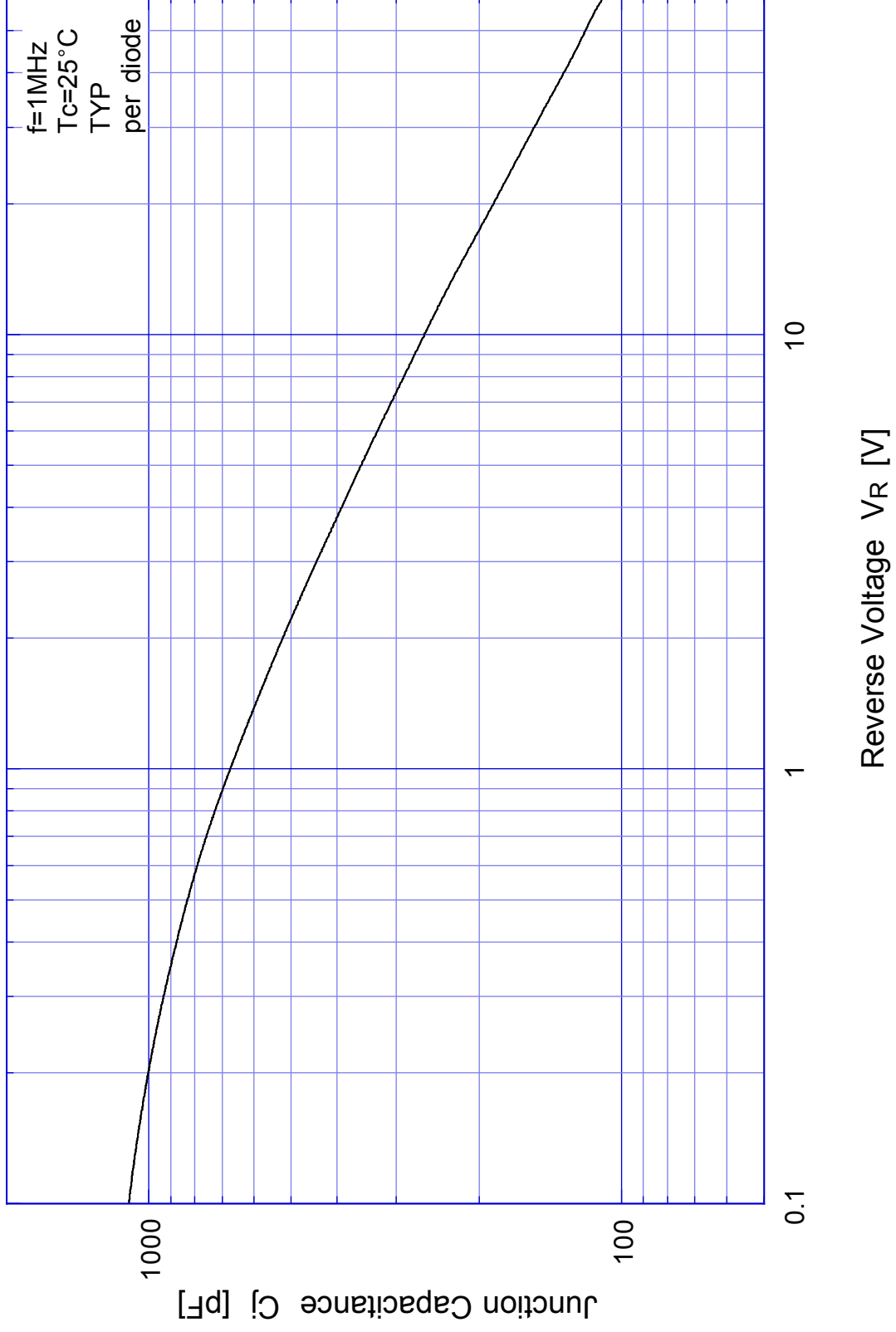

D5S6M

Reverse Current

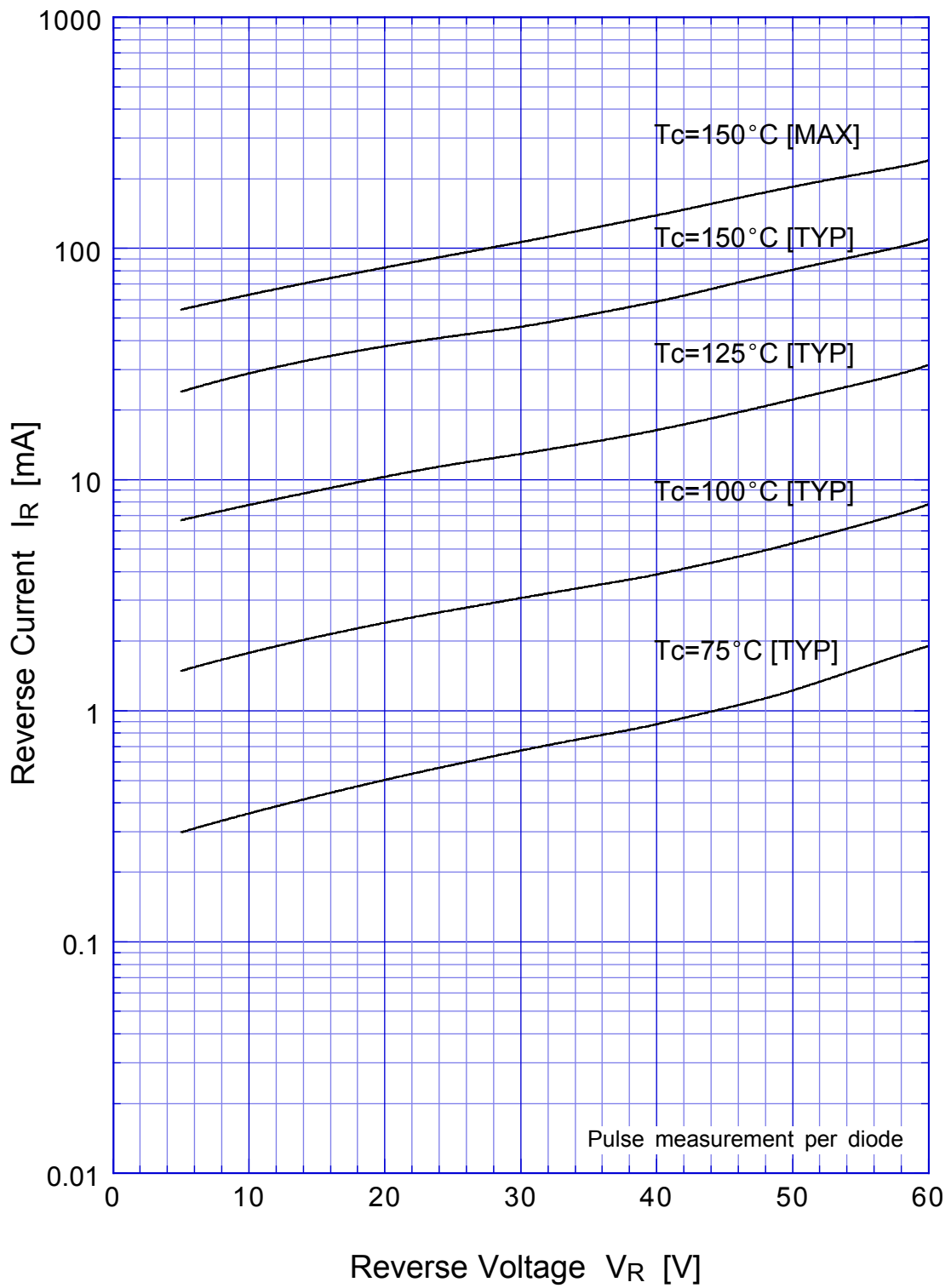

D5S6M

Reverse Power Dissipation

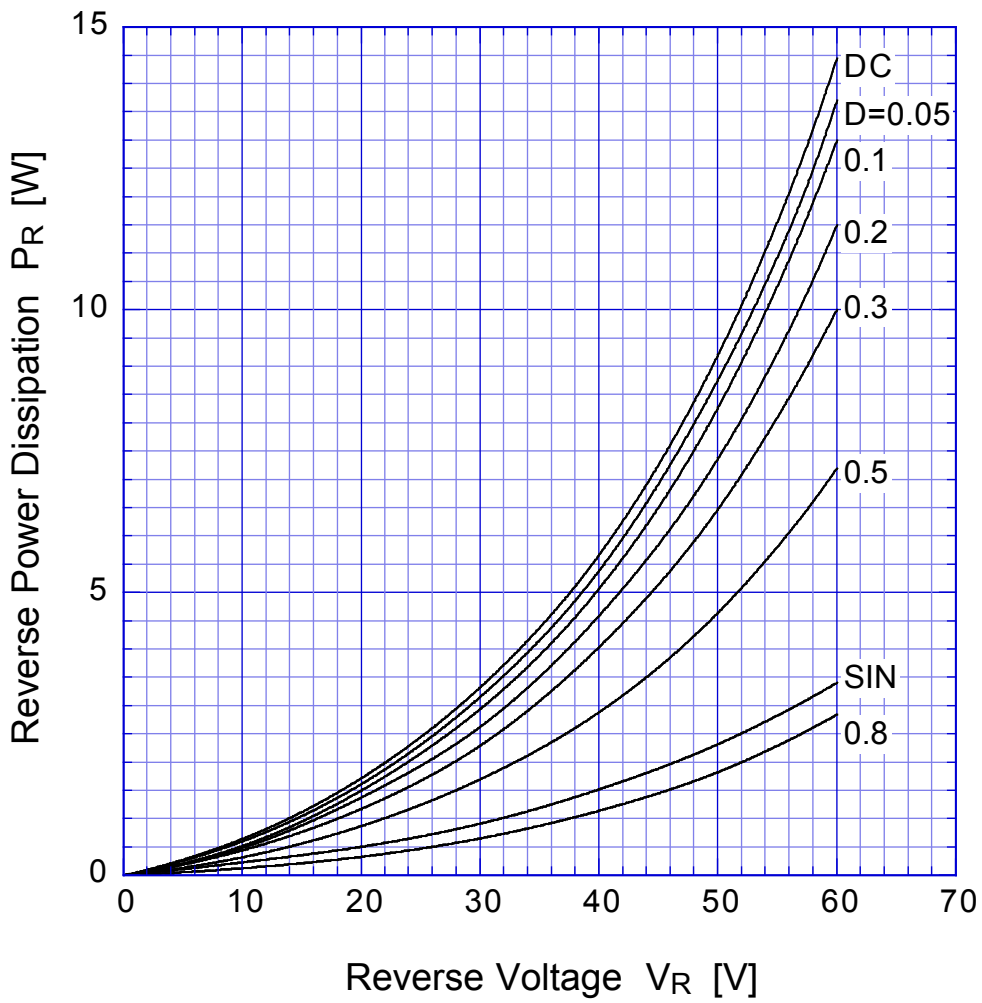

$T_j = 150^\circ\text{C}$

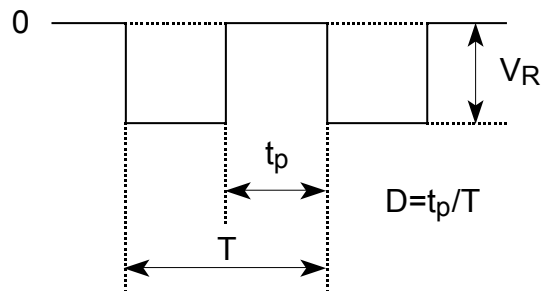

D5S6M

Forward Power Dissipation

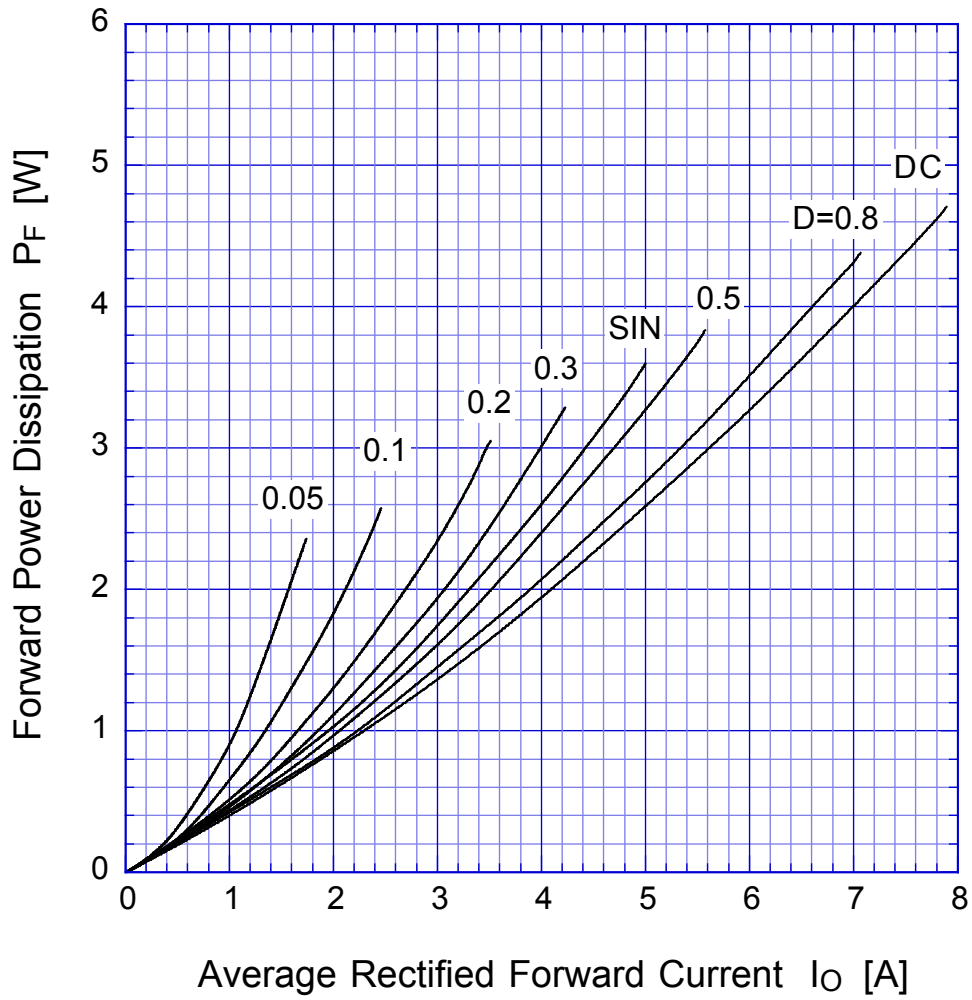

$T_j = 150^\circ\text{C}$

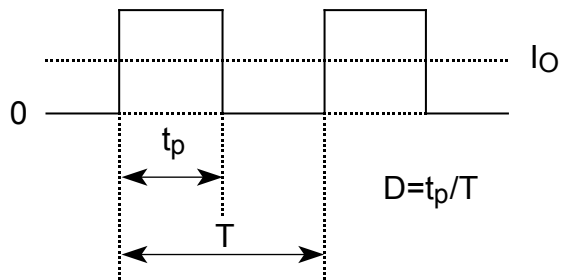

D5S6M

Derating Curve

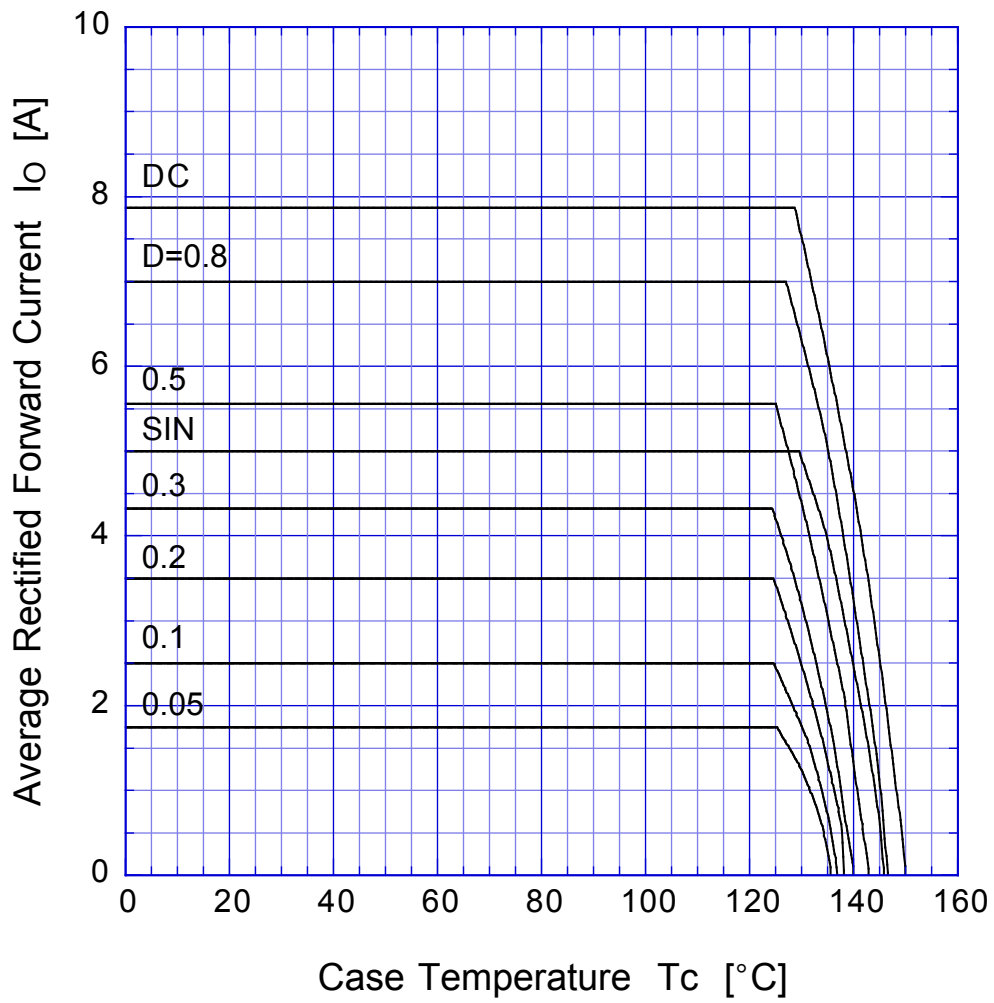

$V_R = 30V$



D5S6M

Derating Curve

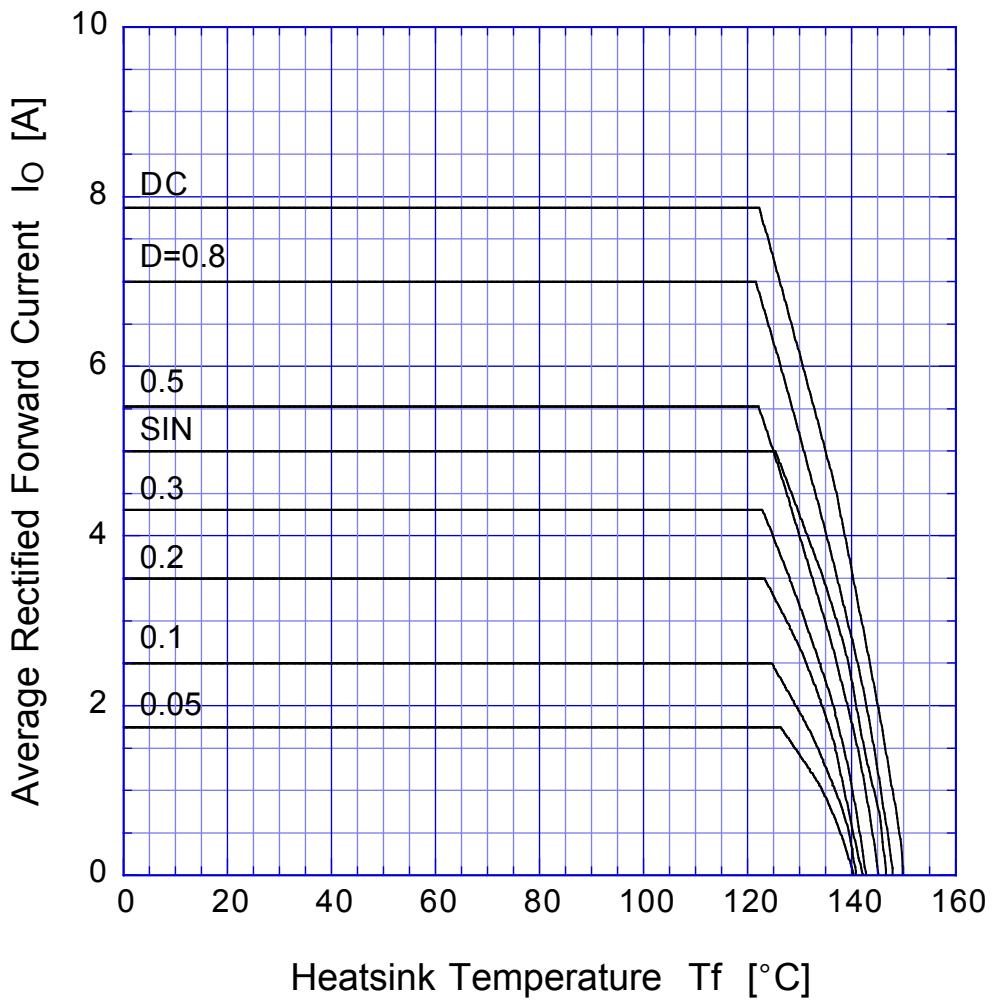

$V_R = 30V$



D5S6M

Peak Surge Forward Capability

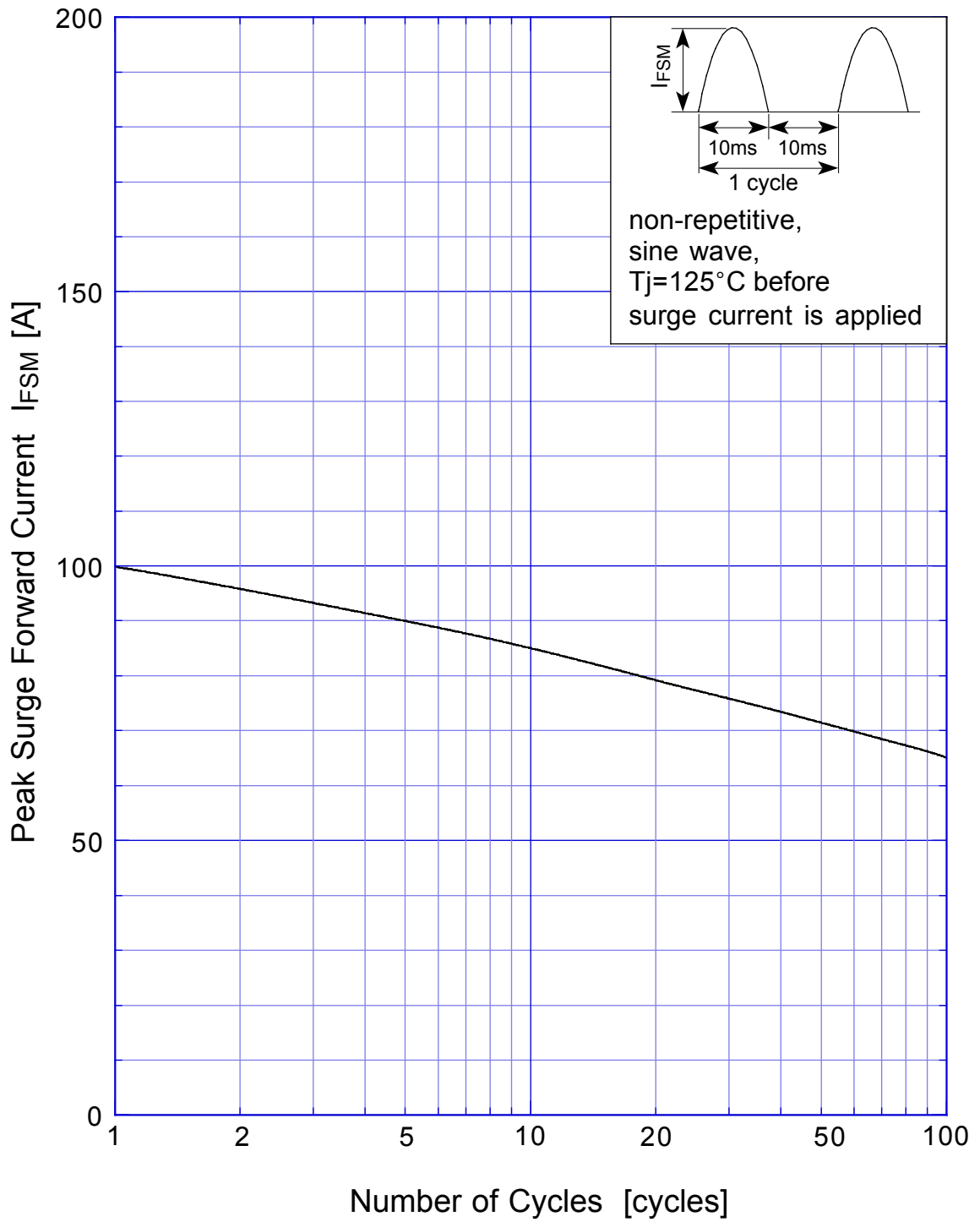

SBD Repetitive Surge Reverse Power Derating Curve



SBD

Repetitive Surge Reverse Power Capability

