

Silicon Carbide Schottky Diode

- Revolutionary semiconductor material - Silicon Carbide
- Switching behavior benchmark
- No reverse recovery
- No temperature influence on the switching behavior
- No forward recovery

Product Summary

V_{RRM}	300	V
Q_C	23	nC
I_F	2x10	A

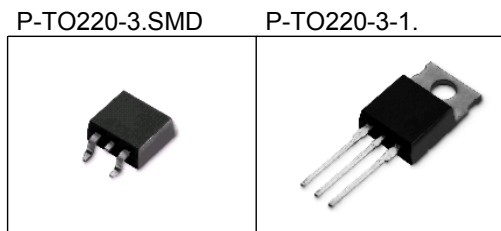

Type	Package	Ordering Code	Marking
SDP20S30	P-TO220-3-1.	Q67040-S4419	D20S30
SDB20S30	P-TO220-3.SMD	Q67040-S4374	S20S30

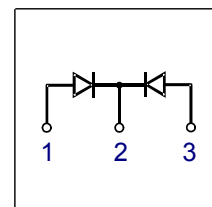

Maximum Ratings, at $T_j = 25\text{ }^\circ\text{C}$, unless otherwise specified (per leg)

Parameter	Symbol	Value	Unit
Continuous forward current, $T_C=100^\circ\text{C}$	I_F	10	A
RMS forward current, $f=50\text{Hz}$	I_{FRMS}	14	
Surge non repetitive forward current, sine halfwave $T_C=25^\circ\text{C}$, $t_p=10\text{ms}$	I_{FSM}	36	
Repetitive peak forward current $T_j=150^\circ\text{C}$, $T_C=100^\circ\text{C}$, $D=0.1$	I_{FRM}	45	
Non repetitive peak forward current $t_p=10\mu\text{s}$, $T_C=25^\circ\text{C}$	I_{FMAX}	100	
i^2t value, $T_C=25^\circ\text{C}$, $t_p=10\text{ms}$	$\int i^2 dt$	6.5	A^2s
Repetitive peak reverse voltage	V_{RRM}	300	V
Surge peak reverse voltage	V_{RSM}	300	
Power dissipation, single diode mode, $T_C=25^\circ\text{C}$	P_{tot}	65	W
Operating and storage temperature	T_j, T_{stg}	-55... +175	$^\circ\text{C}$

Thermal Characteristics

Parameter	Symbol	Values			Unit
		min.	typ.	max.	
Characteristics					
Thermal resistance, junction - case (per leg)	R_{thJC}	-	-	2.3	K/W
SMD version, device on PCB:	R_{thJA}				
P-TO263-3-2: @ min. footprint		-	-	62	
P-TO263-3-2: @ 6 cm ² cooling area ¹⁾		-	35	-	

Electrical Characteristics, at $T_j = 25\text{ }^\circ\text{C}$, unless otherwise specified (per leg)

Parameter	Symbol	Values			Unit
		min.	typ.	max.	
Static Characteristics					
Diode forward voltage	V_F				V
$I_F=10\text{A}$, $T_j=25\text{ }^\circ\text{C}$		-	1.5	1.7	
$I_F=10\text{A}$, $T_j=150\text{ }^\circ\text{C}$		-	1.5	1.9	
Reverse current	I_R				μA
$V_R=300\text{V}$, $T_j=25\text{ }^\circ\text{C}$		-	15	200	
$V_R=300\text{V}$, $T_j=150\text{ }^\circ\text{C}$		-	20	1000	

¹⁾Device on 40mm*40mm*1.5mm epoxy PCB FR4 with 6cm² (one layer, 70 μm thick) copper area for drain connection. PCB is vertical without blown air.

Electrical Characteristics, at $T_j = 25\text{ }^\circ\text{C}$, unless otherwise specified (per leg)

Parameter	Symbol	Values			Unit
		min.	typ.	max.	
AC Characteristics					
Total capacitive charge ¹⁾ $V_R=200\text{V}$, $I_F=10\text{A}$, $di_F/dt=-200\text{A}/\mu\text{s}$, $T_j=150\text{ }^\circ\text{C}$	Q_C	-	23	-	nC
Switching time ²⁾ $V_R=200\text{V}$, $I_F=10\text{A}$, $di_F/dt=-200\text{A}/\mu\text{s}$, $T_j=150\text{ }^\circ\text{C}$	t_{rr}	-	n.a.	-	ns
Total capacitance $V_R=0\text{V}$, $T_C=25\text{ }^\circ\text{C}$, $f=1\text{MHz}$ $V_R=150\text{V}$, $T_C=25\text{ }^\circ\text{C}$, $f=1\text{MHz}$ $V_R=300\text{V}$, $T_C=25\text{ }^\circ\text{C}$, $f=1\text{MHz}$	C	-	600 55 40	-	pF

1 Power dissipation (per leg)

$P_{tot} = f(T_C)$

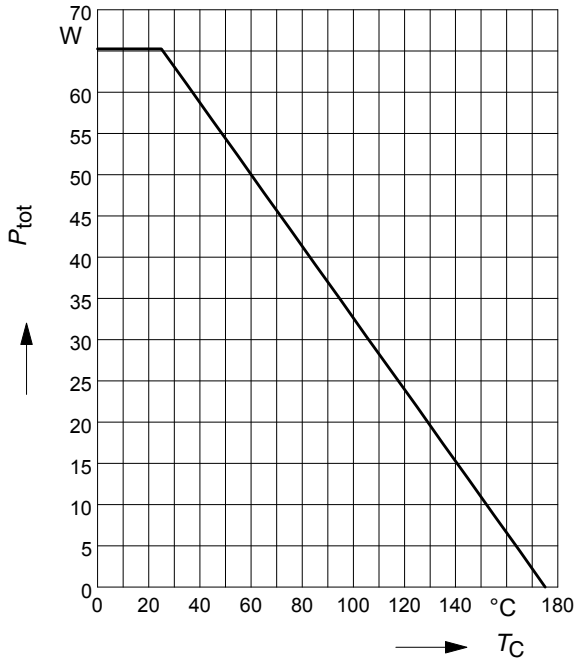

2 Diode forward current (per leg)

$I_F = f(T_C)$

parameter: $T_j \leq 175^\circ\text{C}$

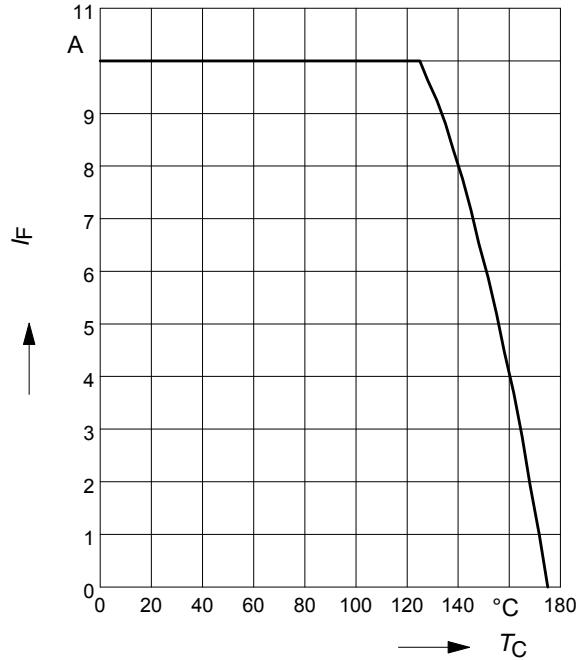

3 Typ. forward characteristic (per leg)

$I_F = f(V_F)$

parameter: $T_j, t_p = 350 \mu\text{s}$

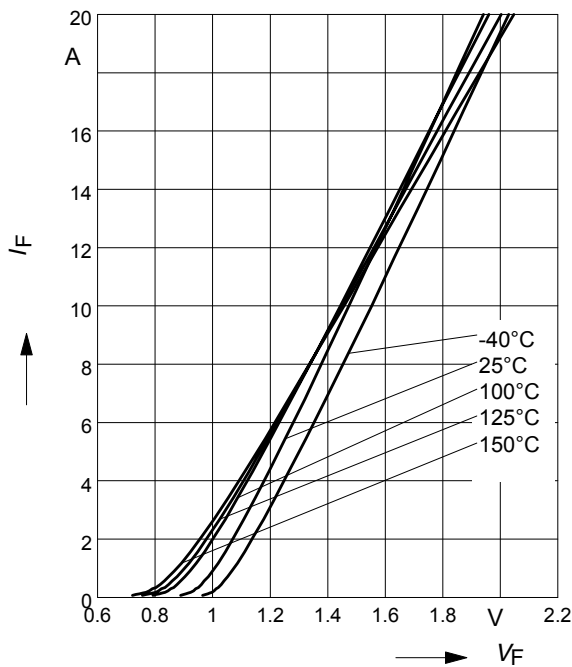

4 Typ. forward power dissipation vs. average forward current (per leg)

$P_{F(AV)} = f(I_F) \quad T_C = 100^\circ\text{C}, d = t_p/T$

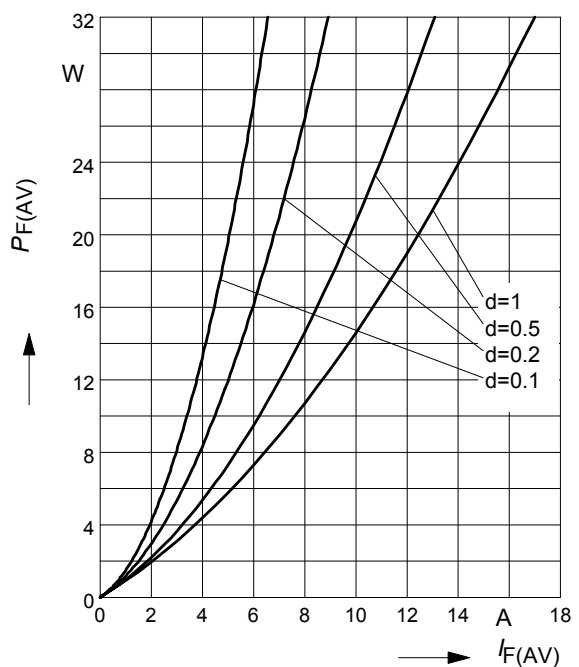

5 Typ. reverse current vs. reverse voltage
(per leg) $I_R = f(V_R)$

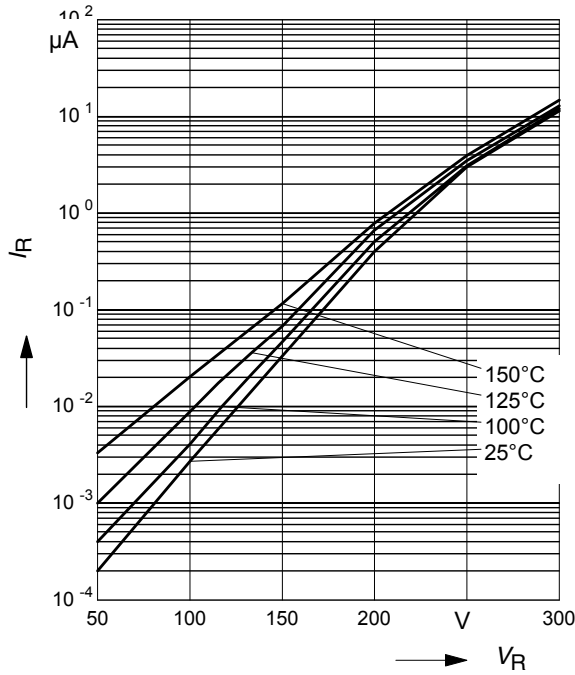

6 Transient thermal impedance (per leg)

$Z_{thJC} = f(t_p)$
parameter : $D = t_p/T$

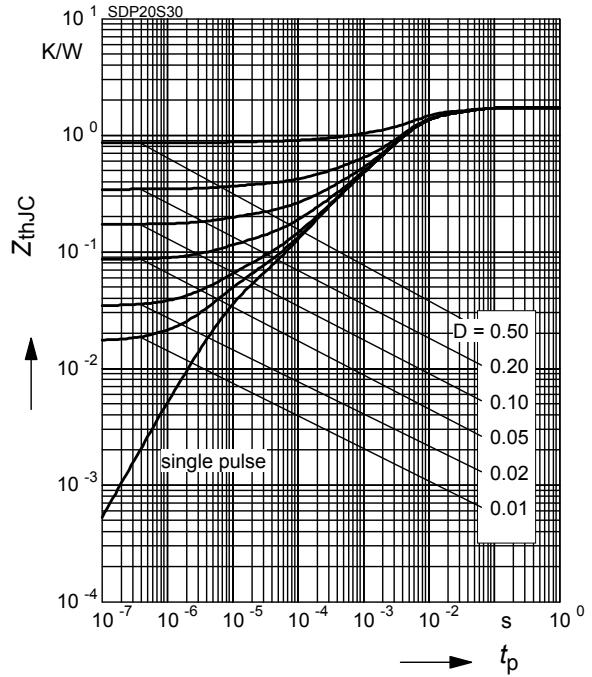

7 Typ. capacitance vs. reverse voltage
(per leg) $C = f(V_R)$

parameter: $T_C = 25^\circ C, f = 1 MHz$

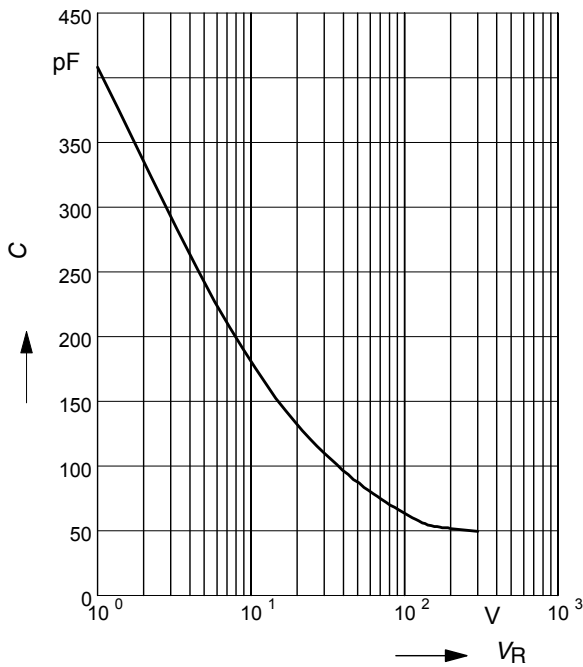

8 Typ. C stored energy (per leg)

$E_C = f(V_R)$

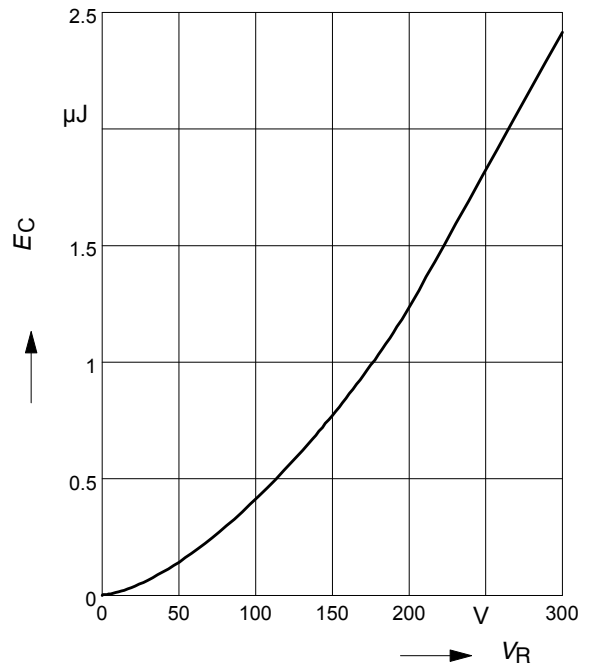

9 Typ. capacitive charge vs. current slope

(per leg) $Q_c = f(di_F/dt)$

parameter: $T_j = 150\text{ }^\circ\text{C}$

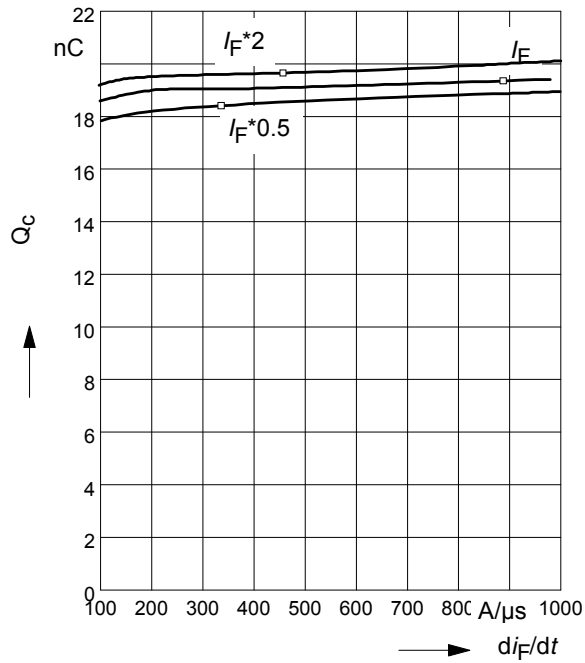

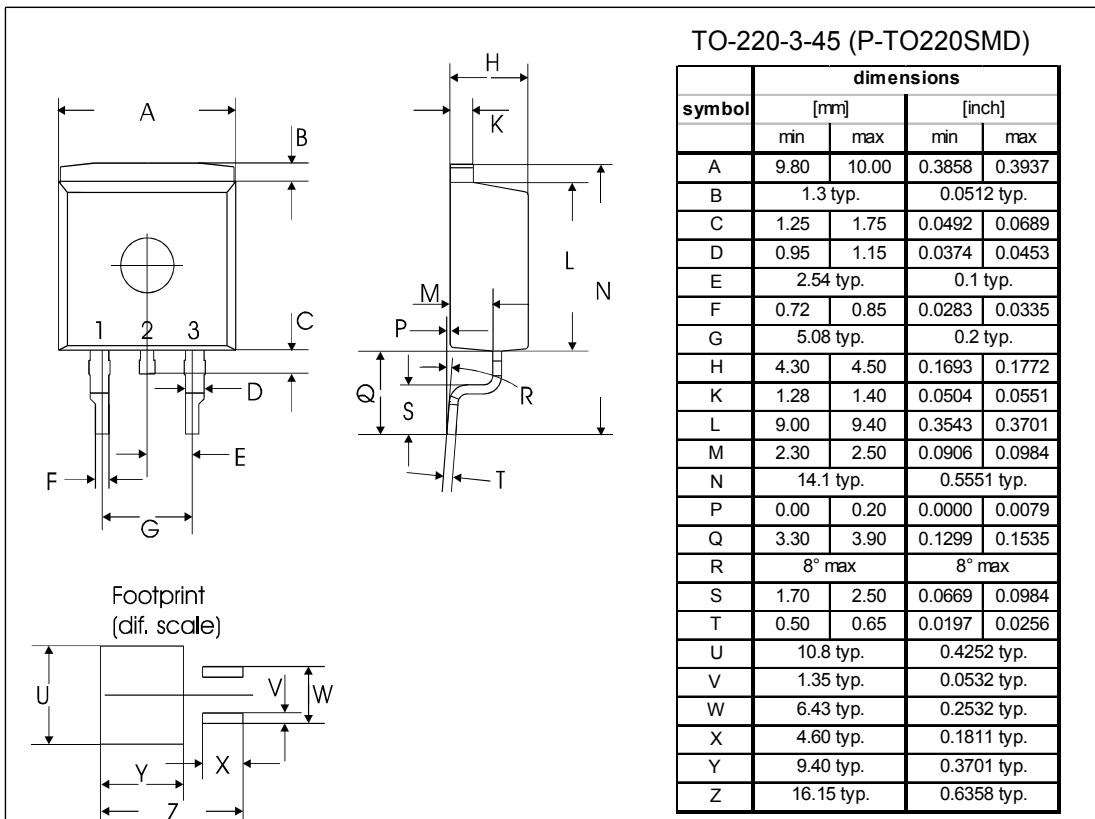
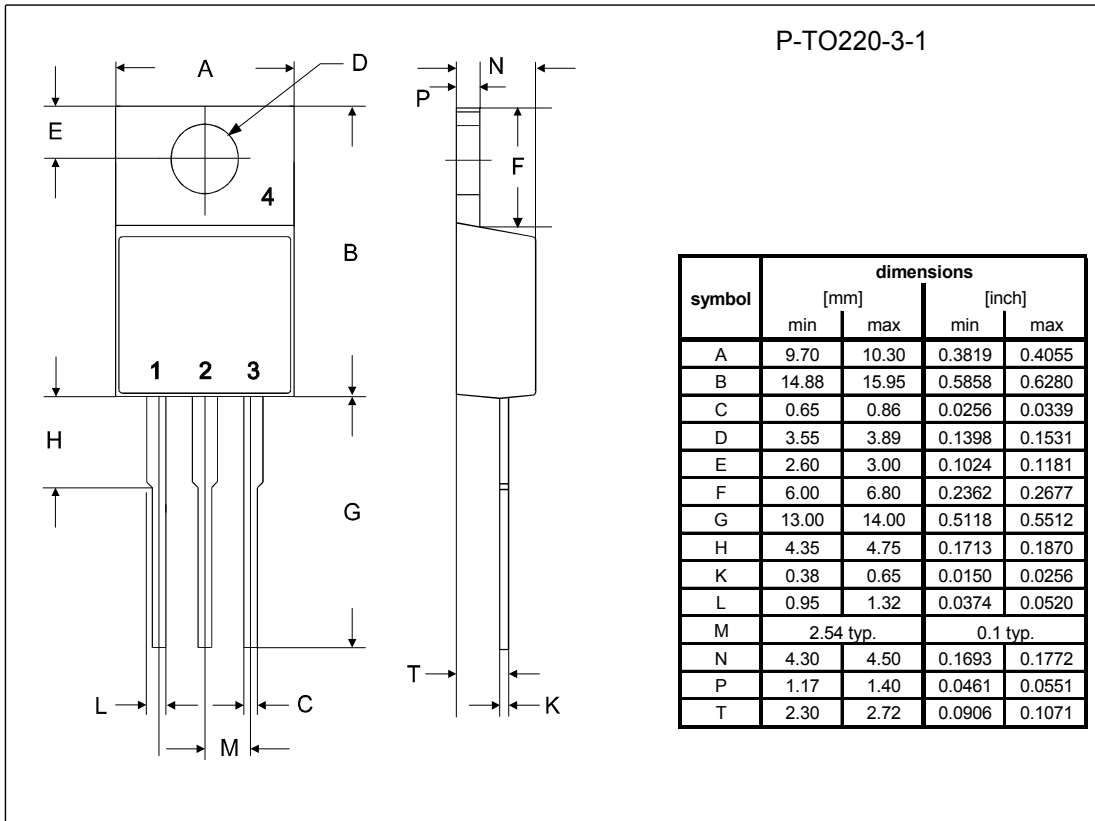

Published by
Infineon Technologies AG,
Bereichs Kommunikation
St.-Martin-Strasse 53,
D-81541 München
© Infineon Technologies AG 1999
All Rights Reserved.

Attention please!

The information herein is given to describe certain components and shall not be considered as warranted characteristics.

Terms of delivery and rights to technical change reserved.

We hereby disclaim any and all warranties, including but not limited to warranties of non-infringement, regarding circuits, descriptions and charts stated herein.

Infineon Technologies is an approved CECC manufacturer.

Information

For further information on technology, delivery terms and conditions and prices please contact your nearest Infineon Technologies Office in Germany or our Infineon Technologies Representatives worldwide (see address list).

Warnings

Due to technical requirements components may contain dangerous substances.

For information on the types in question please contact your nearest Infineon Technologies Office.

Infineon Technologies Components may only be used in life-support devices or systems with the express written approval of Infineon Technologies, if a failure of such components can reasonably be expected to cause the failure of that life-support device or system, or to affect the safety or effectiveness of that device or system. Life support devices or systems are intended to be implanted in the human body, or to support and/or maintain and sustain and/or protect human life. If they fail, it is reasonable to assume that the health of the user or other persons may be endangered.