

1. PART NO. EXPRESSION :

S D B 0 8 0 5 1 0 1 M Z F
 (a) (b) (c) (d)(e)(f)

- (a) Series code
- (b) Dimension code
- (c) Inductance code : 101 = 100uH
- (d) Tolerance code : M = ±20%
- (e) X, Y, Z : Standard part
- (f) F : Lead Free

2. CONFIGURATION & DIMENSIONS :

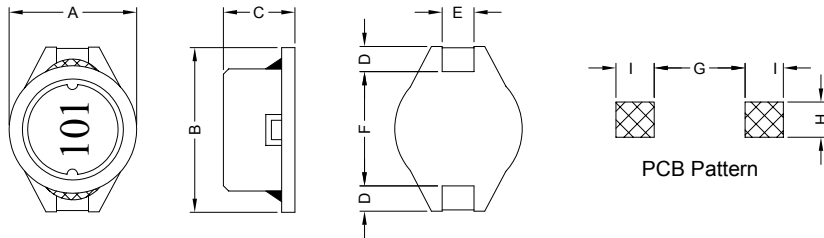

Unit:m/m

A	B	C	D	E	F	G	H	I
8.0±0.2	10.5±0.2	4.5±0.3	2.1±0.2	2.0±0.2	6.0±0.3	5.7 Ref.	2.2 Ref.	2.4 Ref.

3. SCHEMATIC :

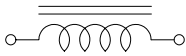

4. MATERIALS :

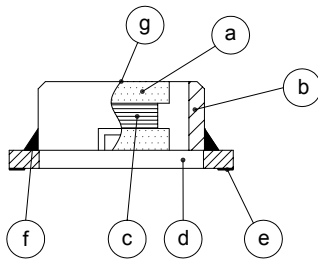

- (a) Core : DR Ferrite Core
- (b) Core : RI Ferrite Core
- (c) Wire : Enamelled Copper Wire
- (d) Base : LCP
- (e) Terminal : Tinned Copper Plate
- (f) Adhesive : Epoxy
- (g) Ink : Bon Margue

5. GENERAL SPECIFICATION :

- a) Temp. rise : 40°C Max.
- b) Rated current : Base on temp. rise & ΔL/L0A = 10% Max.
- c) Storage temp. : -40°C to +125°C
- d) Operating temp. : -40°C to +85°C
- e) Resistance to solder heat : 260°C.10 secs



RoHS Compliant

NOTE : Specifications subject to change without notice. Please check our website for latest information.

05.05.2008



SUPERWORLD ELECTRONICS (S) PTE LTD

6. ELECTRICAL CHARACTERISTICS :

Part No.	Inductance (μ H)	Q Ref.	Test Frequency (Hz)	SRF (MHz) Typ.	RDC (m Ω) Max.	IDC (A)
SDB08052R2MZF	2.2 \pm 20%	60	1V/100K	75.0	40	2.50
SDB08053R9MZF	3.9 \pm 20%	60	1V/100K	50.0	55	2.10
SDB08055R6MZF	5.6 \pm 20%	60	1V/100K	40.0	65	1.95
SDB08058R2MZF	8.2 \pm 20%	60	1V/100K	32.0	80	1.75
SDB0805100MZF	10.0 \pm 20%	50	1V/100K	28.0	100	1.50
SDB0805120MZF	12.0 \pm 20%	50	1V/100K	24.0	120	1.40
SDB0805150MZF	15.0 \pm 20%	50	1V/100K	22.0	140	1.30
SDB0805180LZF	18.0 \pm 15%	50	1V/100K	19.0	160	1.20
SDB0805220LZF	22.0 \pm 15%	50	1V/100K	17.0	180	1.10
SDB0805270LZF	27.0 \pm 15%	50	1V/100K	15.5	200	1.00
SDB0805330LZF	33.0 \pm 15%	60	1V/100K	13.5	240	0.92
SDB0805390LZF	39.0 \pm 15%	60	1V/100K	12.0	260	0.84
SDB0805470LZF	47.0 \pm 15%	60	1V/100K	10.5	280	0.75
SDB0805560MZF	56.0 \pm 10%	60	1V/100K	9.5	380	0.68
SDB0805680MZF	68.0 \pm 10%	70	1V/100K	9.0	440	0.60
SDB0805820MZF	82.0 \pm 10%	70	1V/100K	8.5	550	0.54
SDB0805101MZF	100.0 \pm 10%	70	1V/100K	7.5	600	0.50
SDB0805121MZF	120.0 \pm 10%	70	1V/100K	7.0	750	0.45
SDB0805151MZF	150.0 \pm 10%	70	1V/100K	6.5	900	0.40
SDB0805181MZF	180.0 \pm 10%	70	1V/100K	4.8	1050	0.35
SDB0805221MZF	220.0 \pm 10%	80	1V/100K	4.5	1180	0.30
SDB0805271MZF	270.0 \pm 10%	90	1V/100K	4.2	1400	0.27
SDB0805331MZF	330.0 \pm 10%	90	1V/100K	3.8	1800	0.24
SDB0805391MZF	390.0 \pm 10%	80	1V/100K	3.6	2100	0.22
SDB0805471MZF	470.0 \pm 10%	80	1V/100K	3.5	2250	0.20
SDB0805561MZF	560.0 \pm 10%	100	1V/100K	3.0	3000	0.18
SDB0805681MZF	680.0 \pm 10%	90	1V/100K	2.8	3400	0.17
SDB0805821MZF	820.0 \pm 10%	90	1V/100K	2.5	4000	0.16
SDB0805102MZF	1000.0 \pm 10%	90	1V/100K	2.2	5000	0.15



RoHS Compliant

NOTE : Specifications subject to change without notice. Please check our website for latest information.

05.05.2008



SUPERWORLD ELECTRONICS (S) PTE LTD

6. ELECTRICAL CHARACTERISTICS :

@ TEMP. RISE VS. DC SUPERPOSITION RESPONSE CURVE

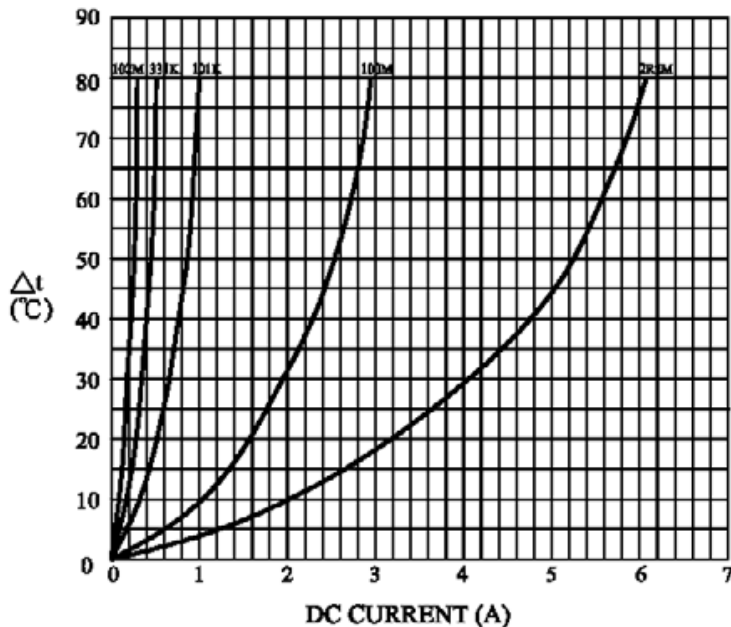

@ INDUCTANCE VS. FREQUENCY RESPONSE CURVE

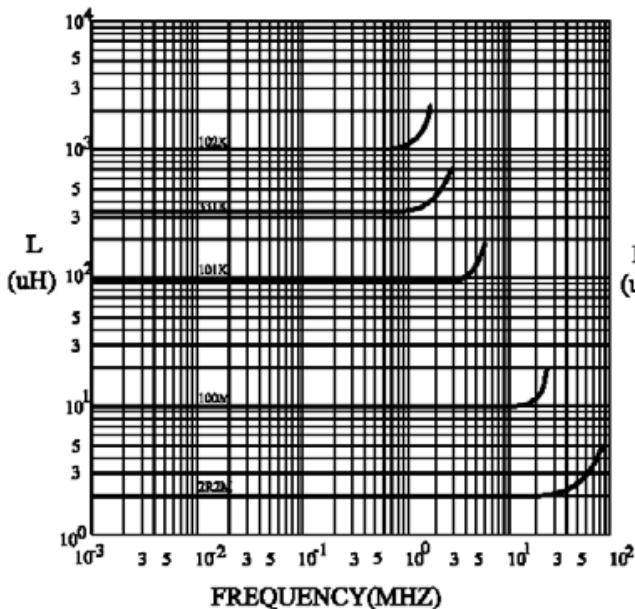

@ INDUCTANCE VS. DC SUPERPOSITION RESPONSE CURVE

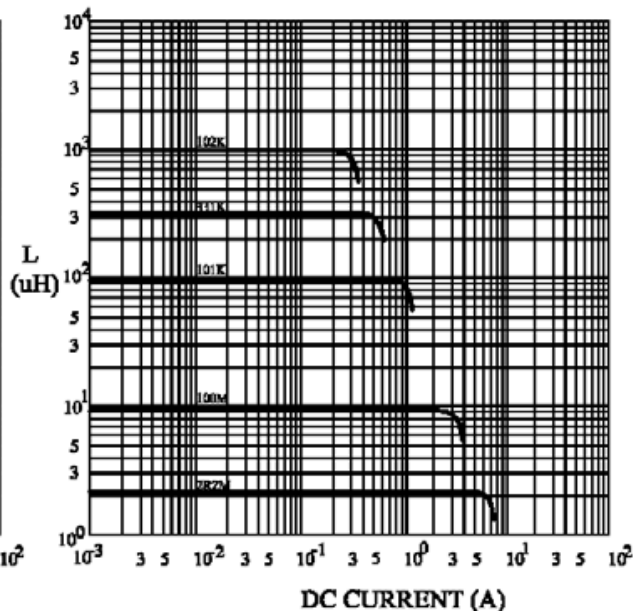

NOTE : Specifications subject to change without notice. Please check our website for latest information.



RoHS Compliant

05.05.2008



RECOMMENDED SOLDERING CONDITIONS REFLOW SOLDERINGS

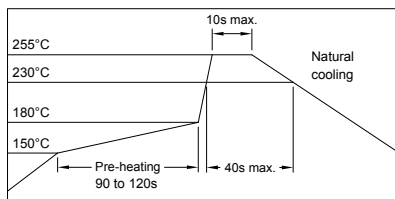

7. PACKAGING INFORMATION :

(1) CONFIGURATION

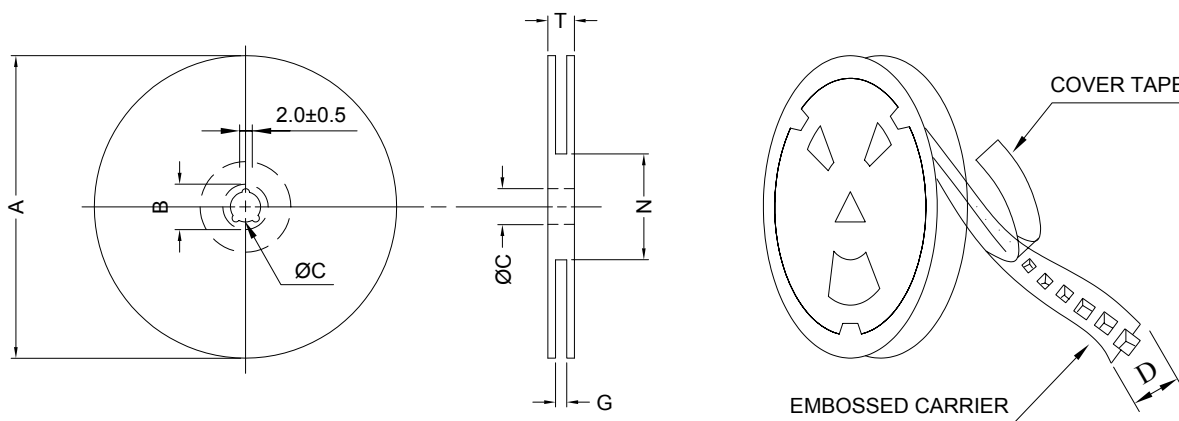

* CARRIER TAPE WIDTH : D

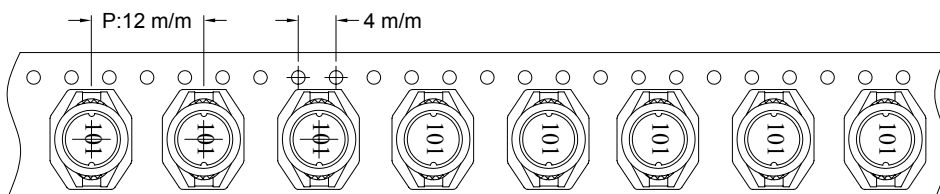

(2) DIMENSIONS

Unit:m/m

STYLE	A	B	C	D	G	N	T
13-24	330	21±0.8	13	24	26 ⁺⁰	50 ⁻⁰	30.4

(3) Q'TY & G.W. PER PACKAGE

SERIES	INNER : REEL			OUTER : CARTON		
	Q'TY (PCS)	G.W. (gw)	STYLE	Q'TY (PCS)	G.W. (Kg)	SIZE (cm)
SDB0805	1000	1100	13-24	4000	7.9	40 x 40 x 24



RoHS Compliant

NOTE : Specifications subject to change without notice. Please check our website for latest information.

05.05.2008

8. RELIABILITY AND TEST CONDITION :

TEST ITEM	SPECIFICATION	TEST CONDITION
SOLDERABILITY	MORE THAN 90% OF THE TERMINAL ELECTRODE SHALL BE COVERED WITH FRESH SOLDER.	PREHEAT : 125±25°C FOR 60 SECONDS SOLDER : 99%Sn/0.3%Ag/0.7%Cu OR EQUIVALENT SOLDER TEMP. : 245±5°C FLUX : ROSIN DIP TIME : 4±1 SECONDS
THERMAL SHOCK TEST (TEMP. CYCLE)	INDUCTANCE SHALL NOT CHANGE MORE THAN ±20%	ROOM TEMP. → -25±2°C 15 MINUTES 30 MINUTES ROOM TEMP. → 85±2°C 15 MINUTES 30 MINUTES TOTAL : 50 CYCLES
HUMIDITY RESISTANCE TEST		TEMPERATURE : 40±2°C HUMIDITY : 90 ~ 95% APPLIED CURRENT : PER SPEC. TIME : 500 HOURS
HIGH TEMP. RESISTANCE TEST		TEMPERATURE : 85±2°C APPLIED CURRENT : PER SPEC. TIME : 500 HOURS



RoHS Compliant

NOTE : Specifications subject to change without notice. Please check our website for latest information.

05.05.2008



SUPERWORLD ELECTRONICS (S) PTE LTD

9. UL CARD :

OBMW2 **November 30, 2000**
Magnet Wire - Component

PACIFIC ELECTRIC WIRE & CABLE (SHENZHEN) CO LTD **E201757**
 607 BAOLONG INDUSTRIAL ESTATE LONGGANG, SHENZHEN
 GUANGDONG CHINA

Mtl Dsg	BC	Coating Type	TC	ANSI Type	TI
UEW/U		Polyurethane	—	—	130
PEW/U		Polyester	—	MW5-C	155°C
PEWH/U		Modified Polyester	—	MW30-C	180
PEW-NY/U		Polyester	Polyamide	MW24-C	155
HAI/U		Polyester(Amide)(Imide)	Polyamideimide	MW35,73	200
UEW-NY/U		Polyurethane	Polyamide	MW80-C	155
				MW28-C	130

Marking: Company name and material designation or marked designation on package or reel, and Recognized Component Mark.

See General Information Preceding These Recognitions

1/3/2001 Underwriters Laboratories Inc. Card 1 of 2

SUMITOMO CHEMICAL CO LTD **E54705 (M)**
 5-33 KITAHAMA 4-CHOME CHUO-KO, OSAKA JAPAN

Mtl Dsg	Col	Min Thk mm	UL94 Flame Class	Elec	RTI		H W I	H A I	H V R	D 4 5	C T I
					with Imp	Mech w/o Imp					
Liquid crystal polyester (LCP), designated "EKONOL" or "SUMIKASUPER", furnished in the form of pellets, (Contd)											
E4008, E400X	NC, BK	0.30	94V-0	130	130	130	—	—	—	—	—
		0.75	94V-0	130	130	130	3	4	—	—	—
		1.5	94V-0	130	130	130	2	4	—	—	—
		3.0	94V-0	130	130	130	1	4	0	5	4
E4008	NC, WT, BK	0.30	94V-0	130	130	130	—	—	—	—	—
		0.75	94V-0	220	180	220	3	4	—	—	—
		1.5	94V-0	220	200	240	2	4	—	—	—
		3.0	94V-0	220	200	240	1	4	0	5	4
E4010	NC, BK	0.30	94V-0	130	130	130	—	—	—	—	—
		0.75	94V-0	220	180	220	3	4	—	—	—
		1.5	94V-0	220	200	240	2	4	—	—	—
		3.0	94V-0	220	200	240	1	4	0	5	4
E400(Y)L, E4008L	NC, BK	0.30	94V-0	130	130	130	—	—	—	—	—
		0.75	94V-0	130	130	130	3	4	—	—	—
		1.5	94V-0	130	130	130	2	4	—	—	—
		3.0	94V-0	130	130	130	1	4	0	5	4
E4810	NC, BK	0.30	94V-0	130	130	130	—	—	—	—	—
		0.75	94V-0	130	130	130	0	4	—	—	—
		1.5	94V-0	130	130	130	0	4	—	—	—
		3.0	94V-0	130	130	130	1	4	0	5	4

(X) Denotes any number 1 thru 9.
 (Y) Denotes any number 1 thru 7.



RoHS Compliant

NOTE : Specifications subject to change without notice. Please check our website for latest information.

05.05.2008



SUPERWORLD ELECTRONICS (S) PTE LTD