

Three Phase Half Controlled Rectifier Bridge, B6HK

 $I_{dAVM} = 110/167 \text{ A}$
 $V_{RRM} = 1200-1600 \text{ V}$

| V_{RSM} V_{DSM} V | V_{RRM} V_{DRM} V | Type | |
|-----------------------------|-----------------------------|---------------|---------------|
| 1300 | 1200 | VVZ 110-12io7 | VVZ 175-12io7 |
| 1500 | 1400 | VVZ 110-14io7 | VVZ 175-14io7 |
| 1700 | 1600 | | VVZ 175-16io7 |

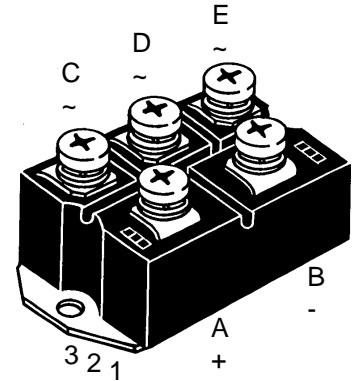
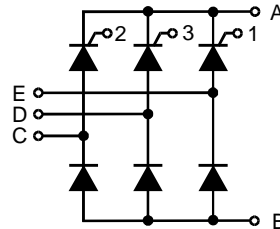

| Symbol | Test Conditions | Maximum Ratings | | |
|-----------------------------------|--|-----------------------------------|----------------|--|
| | | VVZ 110 | VVZ 175 | |
| I_{dAV} I_{FRMS}, I_{TRMS} | $T_C = 85^\circ\text{C}$; module per leg | 110 58 | 167 89 | A A |
| I_{FSM}, I_{TSM} | $T_{VJ} = 45^\circ\text{C}$; $V_R = 0$ $T_{VJ} = T_{VJM}$; $V_R = 0$ $t = 10 \text{ ms (50 Hz), sine}$ $t = 8.3 \text{ ms (60 Hz), sine}$ | 1150 1230 | 1500 1600 | A A |
| I^2t | $T_{VJ} = 45^\circ\text{C}$; $V_R = 0$ $T_{VJ} = T_{VJM}$; $V_R = 0$ $t = 10 \text{ ms (50 Hz), sine}$ $t = 8.3 \text{ ms (60 Hz), sine}$ | 6600 6280 | 11200 10750 | A^2s A^2s |
| $(di/dt)_{cr}$ | $T_{VJ} = T_{VJM}$ repetitive, $I_T = 50 \text{ A}$ $f = 400 \text{ Hz}$, $t_p = 200 \mu\text{s}$ $V_D = 2/3 V_{DRM}$ $I_G = 0.3 \text{ A}$, non repetitive, $di_G/dt = 0.3 \text{ A}/\mu\text{s}$, $I_T = 1/3 \cdot I_{dAV}$ | 150 | 500 | $\text{A}/\mu\text{s}$ $\text{A}/\mu\text{s}$ |
| $(dv/dt)_{cr}$ | $T_{VJ} = T_{VJM}$; $V_{DR} = 2/3 V_{DRM}$ $R_{GK} = \infty$; method 1 (linear voltage rise) | 1000 | | $\text{V}/\mu\text{s}$ |
| V_{RGM} | | 10 | | V |
| P_{GM} | $T_{VJ} = T_{VJM}$ $I_T = I_{TAVM}$ $t_p = 30 \mu\text{s}$ $t_p = 500 \mu\text{s}$ $t_p = 10 \text{ ms}$ | ≤ 10 ≤ 5 ≤ 1 | | W W W |
| P_{GAVM} | | 0.5 | | W |
| T_{VJ} | | -40...+125 | | $^\circ\text{C}$ |
| T_{VJM} | | 125 | | $^\circ\text{C}$ |
| T_{stg} | | -40...+125 | | $^\circ\text{C}$ |
| V_{ISOL} | 50/60 Hz, RMS $t = 1 \text{ min}$ $I_{ISOL} \leq 1 \text{ mA}$ $t = 1 \text{ s}$ | 2500 3000 | | V~ V~ |
| M_d | Mounting torque (M6) Terminal connection torque (M6) | 5±15 % 5±15 % | | Nm Nm |
| Weight | typ. | 300 | | g |

Features

- Package with screw terminals
- Isolation voltage 3000 V~
- Planar passivated chips
- UL registered E72873

Applications

- Input rectifier for PWM converter
- Input rectifier for switch mode power supplies (SMPS)
- Softstart capacitor charging

Advantages

- Easy to mount with two screws
- Space and weight savings
- Improved temperature and power cycling

Data according to IEC 60747 and refer to a single thyristor/diode unless otherwise stated.
 IXYS reserves the right to change limits, test conditions and dimensions.

| Symbol | Test Conditions | Characteristic Values | | |
|------------|---|------------------------------|------------|------------------|
| | | VVZ 110 | VVZ 175 | |
| I_R, I_D | $V_R = V_{RRM}; V_D = V_{DRM}$ | $T_{VJ} = T_{VJM}$ | ≤ 5 | mA |
| | | $T_{VJ} = 25^\circ\text{C}$ | ≤ 0.3 | mA |
| V_F, V_T | $I_F, I_T = 200 \text{ A}, T_{VJ} = 25^\circ\text{C}$ | ≤ 1.75 | 1.57 | V |
| V_{T0} | For power-loss calculations only | 0.85 | 0.85 | V |
| r_T | ($T_{VJ} = 125^\circ\text{C}$) | 6 | 3.5 | m Ω |
| V_{GT} | $V_D = 6 \text{ V};$ | $T_{VJ} = 25^\circ\text{C}$ | ≤ 1.5 | V |
| | | $T_{VJ} = -40^\circ\text{C}$ | ≤ 1.6 | V |
| I_{GT} | $V_D = 6 \text{ V};$ | $T_{VJ} = 25^\circ\text{C}$ | ≤ 100 | mA |
| | | $T_{VJ} = -40^\circ\text{C}$ | ≤ 200 | mA |
| V_{GD} | $T_{VJ} = T_{VJM}; V_D = 2/3 V_{DRM}$ | ≤ 0.2 | 0.2 | V |
| I_{GD} | $T_{VJ} = T_{VJM}; V_D = 2/3 V_{DRM}$ | ≤ 5 | 5 | mA |
| I_L | $I_G = 0.3 \text{ A}; t_G = 30 \mu\text{s}; di_G/dt = 0.3 \text{ A}/\mu\text{s}; T_{VJ} = 25^\circ\text{C}$ | ≤ 450 | 450 | mA |
| I_H | $T_{VJ} = 25^\circ\text{C}; V_D = 6 \text{ V}; R_{GK} = \infty$ | ≤ 200 | 200 | mA |
| t_{gd} | $T_{VJ} = 25^\circ\text{C}; V_D = 1/2 V_{DRM}; I_G = 0.3 \text{ A}; di_G/dt = 0.3 \text{ A}/\mu\text{s}$ | ≤ 2 | 2 | μs |
| R_{thJC} | per thyristor (diode); DC current per module | 0.65 | 0.46 | K/W |
| | | 0.108 | 0.077 | K/W |
| R_{thJH} | per thyristor (diode); DC current per module | 0.8 | 0.55 | K/W |
| | | 0.133 | 0.092 | K/W |
| d_s | Creeping distance on surface | 10 | 10 | mm |
| d_A | Creepage distance in air | 9.4 | 9.4 | mm |
| a | Max. allowable acceleration | 50 | 50 | m/s ² |

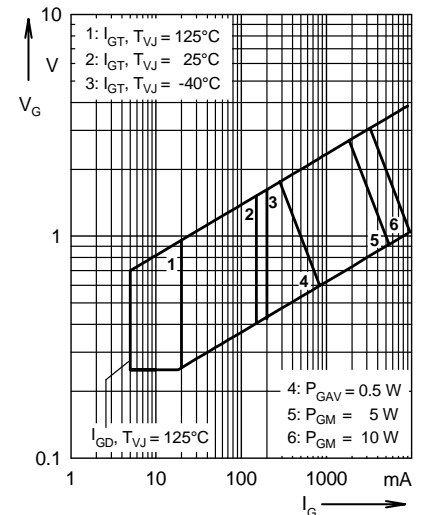

Fig. 1 Gate trigger characteristics

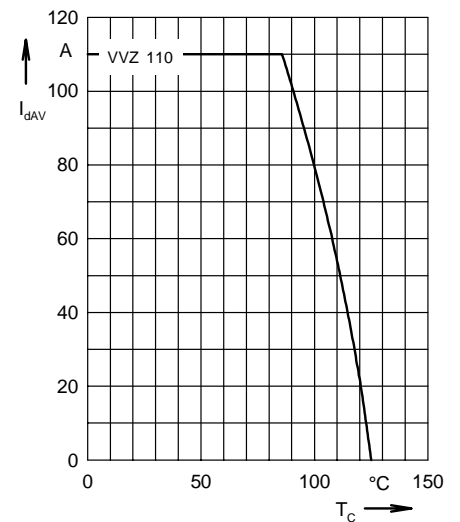

Fig. 2 DC output current at case temperature

Dimensions in mm (1 mm = 0.0394")

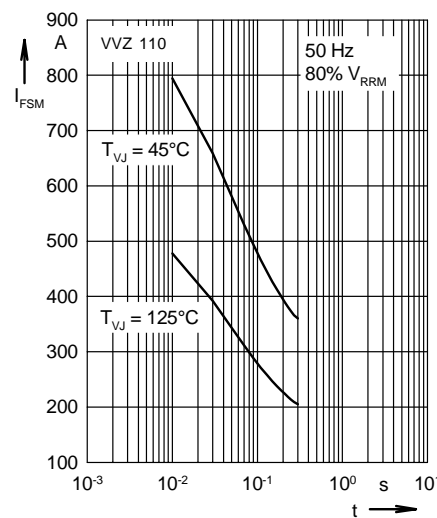
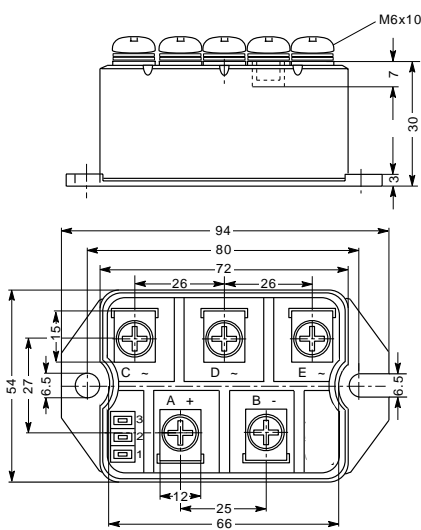

Fig. 3 Surge overload current
 I_{FSM} : Crest value, t: duration

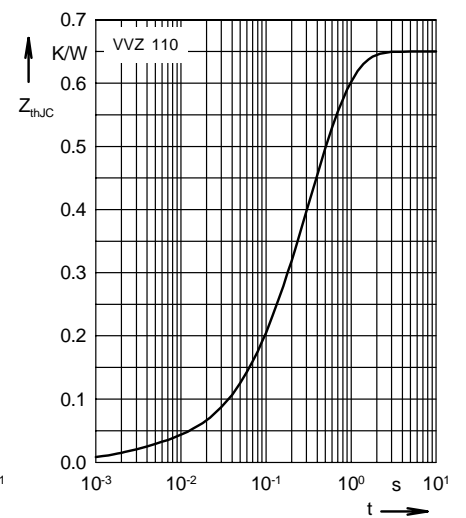

Fig. 4 Transient thermal impedance junction to case (per leg)