

APPLICATIONS

- ✓ T1/E1 Trunk & Line Card
- ✓ SLIC Line Card
- ✓ DBX Branch Exchange Switches
- ✓ FCC Part 68 Customer Premise Equipment
- ✓ Line Interface Modem
- ✓ xDSL Architecture Interface
- ✓ ISDN Architecture Interface

IEC COMPATIBILITY (EN61000-4)

- ✓ 61000-4-2 (ESD): Air - 15kV, Contact - 8kV
- ✓ 61000-4-4 (EFT): 40A - 5/50ns
- ✓ 61000-4-5 (Surge): 8/20 μ s - 95A, L4(Line-Gnd), 48A, L4(Line-Line) & 83A, L2(Power)

FEATURES

- ✓ Complies with: FCC Part 68, UL 1459, Bellcore 1089, ITU-K.20 & K.21
- ✓ UL File Recognition # E208219
- ✓ Peak Off-State Voltage from 25 to 300 Volts
- ✓ Surge Current Capability (See Table 1)
- ✓ ESD Protection > 40 kilovolts
- ✓ Low Capacitance for T1/E1 Trunk & Line Card Applications
- ✓ Bidirectional Configurations
- ✓ RoHS Compliant

MECHANICAL CHARACTERISTICS

- ✓ Molded Plastic DO-214AA Package
- ✓ Weight 2.5 grams (Approximate)
- ✓ Available in Lead-Free Pure-Tin Plating(Annealed)
- ✓ Solder Reflow Temperature:
Pure-Tin - Sn, 100: 260-270°C
- ✓ Leaded Device Availability
- ✓ Flammability Rating UL 94V-0
- ✓ 12mm Tape and Reel Per EIA Standard 481
- ✓ Marking: Logo & Marking Code

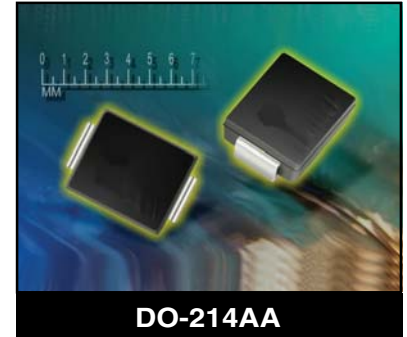
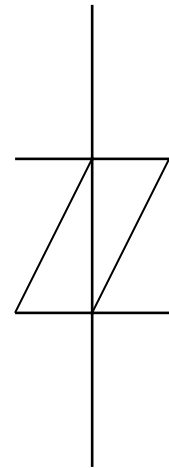
DO-214AA
**DEVICE SYMBOL
(BIDIRECTIONAL)**

TABLE 1 - SURGE RATINGS

SERIES	I_{PP} 2 X 10 μ s AMPS	I_{PP} 8 X 20 μ s AMPS	I_{PP} 10 X 160 μ s AMPS	I_{PP} 10 X 560 μ s AMPS	I_{PP} 10 X 1000 μ s AMPS	I_{TSM} 60 Hz AMPS	di/dt AMPS/ μ s (See Note 1)	dv/dt V/ μ s (See Note 1)
SA	150	150	100	50	50	20	500	2000
SB	300	300	150	100	80	32	500	2000
SC	500	400	200	200	100	60	500	2000

Note 1: Critical Rate of Rise for On-State Current (di/dt) and Off-State Voltage (dv/dt).

PP0640SA thru PP3500SC

DEVICE CHARACTERISTICS

MAXIMUM RATINGS @ 25°C Unless Otherwise Specified			
PARAMETER	SYMBOL	VALUE	UNITS
Surge Current - 50/60 Hz	I_{TSM}	60	Watts
Junction Temperature	T_A	-40 to 150	°C
Storage Temperature	T_{STG}	-55 to 150	°C
Thermal Resistance (Junction) - SA & SB Series	R_{QJC}	28	°C/Watt
Thermal Resistance (Junction) - SC Series	R_{QJC}	26	°C/Watt
Thermal Resistance (Ambient) - SA & SB Series	R_{QJA}	90	°C/Watt
Thermal Resistance (Ambient) - SC Series	R_{QJA}	85	°C/Watt

ELECTRICAL CHARACTERISTICS PER LINE @ 25°C Unless Otherwise Specified									
PART NUMBER	DEVICE MARKING CODE	REPETITIVE PEAK OFF-STATE VOLTAGE V_{DRM} VOLTS	SWITCHING VOLTAGE @100V/ μ s V_S VOLTS	MINIMUM HOLDING CURRENT (See Fig. 7) I_H mA	SWITCHING CURRENT I_S mA	MAXIMUM OFF-STATE CURRENT (See Fig. 4) @ V_{DRM} I_{DRM} μ A	MAXIMUM ON-STATE VOLTAGE (See Fig. 5) @ I_T V_T VOLTS	ON-STATE CURRENT I_T AMPS	TYPICAL CAPACITANCE (See Note 1) @2V, 1 MHz C pF
PP0640SA	GC	58	77	150	800	5	4	2.2	60
PP0720SA	GD	65	88	150	800	5	4	2.2	60
PP0800SA	GE	75	98	150	800	5	4	2.2	60
PP1100SA	GF	90	130	150	800	5	4	2.2	60
PP1300SA	GG	120	160	150	800	5	4	2.2	40
PP1500SA	GH	140	180	150	800	5	4	2.2	40
PP1800SA	GI	160	220	150	800	5	4	2.2	40
PP2300SA	GJ	190	260	150	800	5	4	2.2	30
PP2600SA	GK	220	300	150	800	5	4	2.2	30
PP3100SA	GL	275	350	150	800	5	4	2.2	30
PP3500SA	GM	300	400	150	800	5	4	2.2	30
PP0300SB	GN	25	40	50	800	5	4	2.2	110
PP0640SB	GP	58	77	150	800	5	4	2.2	60
PP0720SB	GQ	65	88	150	800	5	4	2.2	60
PP0800SB	GR	75	98	150	800	5	4	2.2	60
PP1100SB	GS	90	130	150	800	5	4	2.2	60
PP1300SB	GT	120	160	150	800	5	4	2.2	40
PP1500SB	GU	140	180	150	800	5	4	2.2	40
PP1800SB	GV	160	220	150	800	5	4	2.2	40
PP2300SB	GW	190	260	150	800	5	4	2.2	30
PP2600SB	GX	220	300	150	800	5	4	2.2	30
PP3100SB	GY	275	350	150	800	5	4	2.2	30
PP3500SB	GZ	300	400	150	800	5	4	2.2	30
PP0640SC	HC	58	77	150	800	5	4	2.2	120
PP0720SC	HD	65	88	150	800	5	4	2.2	120
PP0800SC	HE	75	98	150	800	5	4	2.2	120
PP1100SC	HF	90	130	150	800	5	4	2.2	120
PP1300SC	HG	120	160	150	800	5	4	2.2	80
PP1500SC	HH	140	180	150	800	5	4	2.2	80
PP1800SC	HI	160	220	150	800	5	4	2.2	80
PP2300SC	HJ	190	260	150	800	5	4	2.2	60
PP2600SC	HK	220	300	150	800	5	4	2.2	60
PP3100SC	HL	275	350	150	800	5	4	2.2	60
PP3500SC	HM	300	400	150	800	5	4	2.2	60

Note 1: Capacitance imbalance between positive and negative polarities is typically < 15pF.

GRAPHS

FIGURE 1
 PULSE WAVE FORM

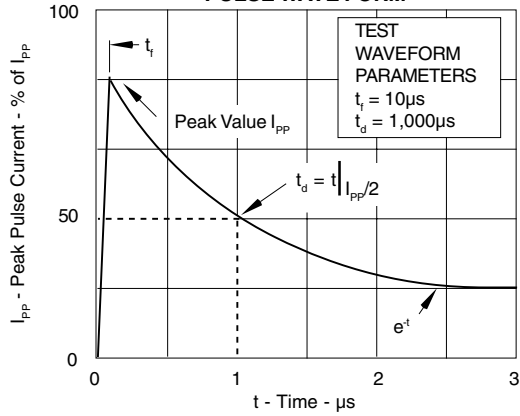

FIGURE 2
 V-I CHARACTERISTIC CURVE

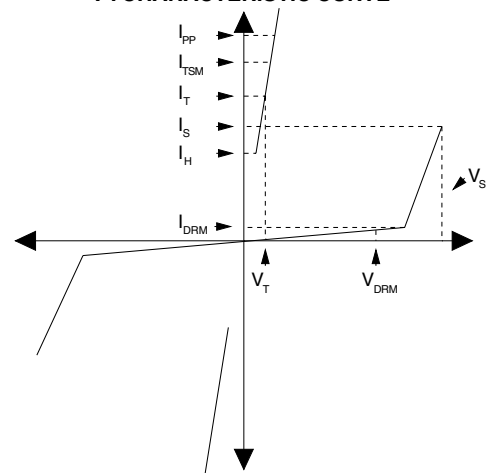
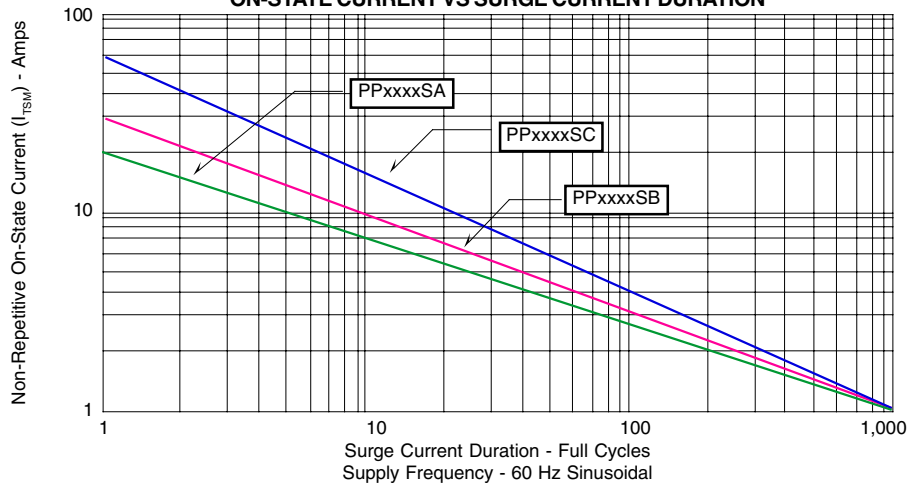

FIGURE 3
 ON-STATE CURRENT VS SURGE CURRENT DURATION



GRAPHS

FIGURE 4

TYPICAL PEAK OFF-STATE CURRENT VS JUNCTION TEMPERATURE

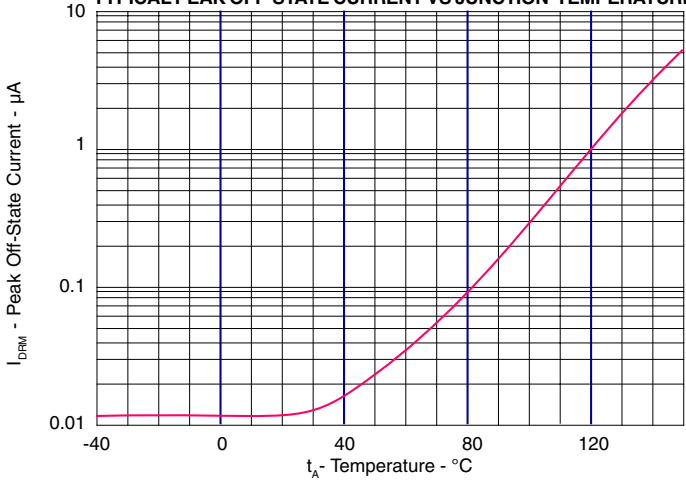

FIGURE 5

TYPICAL ON-STATE CURRENT VS ON-STATE VOLTAGE

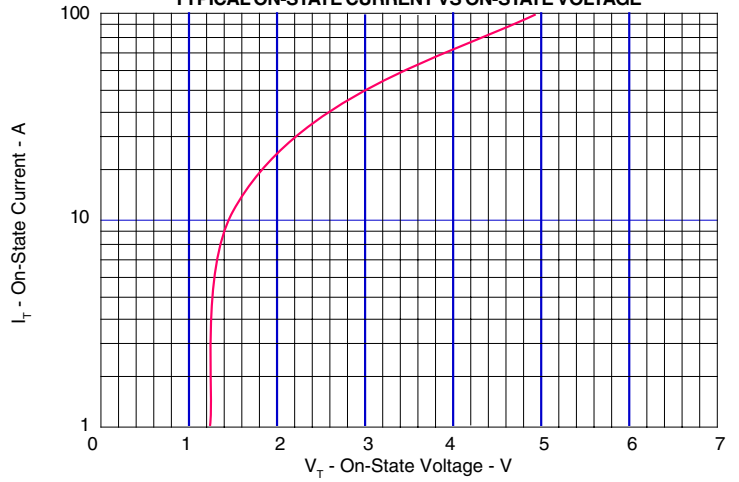

FIGURE 6

TYPICAL NORMALIZED SWITCHING VOLTAGE VS JUNCTION TEMPERATURE

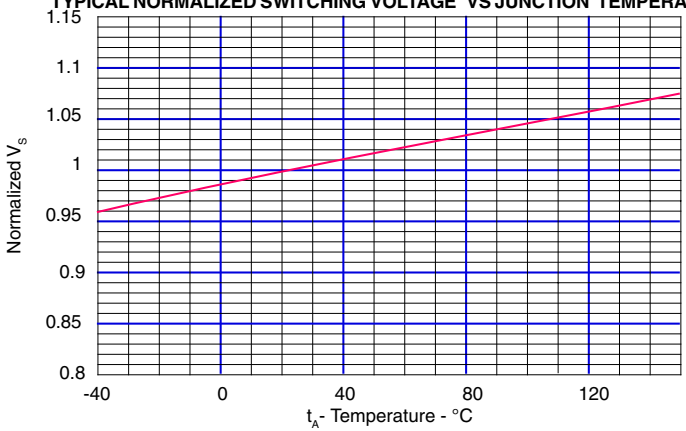
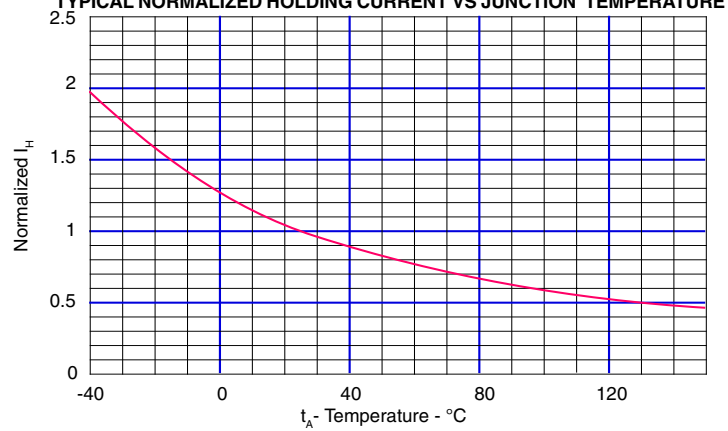

FIGURE 7

TYPICAL NORMALIZED HOLDING CURRENT VS JUNCTION TEMPERATURE



APPLICATION NOTE

FIGURE 1: UL 1459 & FCC Part 68 - Metallic Protection

The TSS (Thyristor Surge Suppressor) device is located across the tip-to-ring after a limiting resistor and fuse combination. R_{TIP} and R_{RING} resistors are optional depending upon the TSS device selection. Without the resistors, the PP3100SB/SC is recommended. However, with a resistance value of 7.5 Ohms for tip and ring, the PP3100SA is recommended. Digital signals may use a lower TSS device depending upon the total tip to ring voltage range. Selection of the TSS device, either PPxxxxSA or SB/SC is based upon the value of the tip and ring resistors. For the National Electric Code (NEC) article 800, it is recommended that at least one fuse be used in the tip or ring line for metallic surges. Fuses may be replaced with a suitable Positive Temperature Coefficient (PTC) automatic resettable current limiting device.

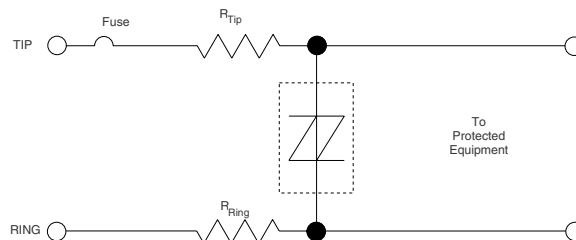

FIGURE 1 - Metallic Protection

FIGURE 2 - UL 1459 & FCC Part 68 - Longitudinal Protection

There are two TSS devices, one located from tip-to-ground and one ring-to-ground. For standard analog signals, the PP3100SA is recommended with a typical resistor value for tip and ring of 15 Ohms. The PP3100SB/SC is recommended for resistor values of 7.5 Ohms each. The National Electric Code (NEC) article 800 requires two fuse elements when connecting to ground. Fuses or a suitable Positive Temperature Coefficient (PTC) automatic resettable current limiting device may be used. The purpose of this circuit is to limit AC power current from getting on the ground line causing any safety hazard.

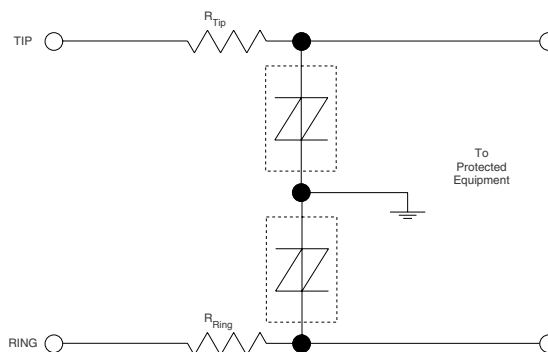

FIGURE 2 - Longitudinal Protection

FIGURE 3 - UL 1459 & FCC Part 68 - Metallic & Longitudinal Protection

Three equal TSS devices are used in this application for metallic (tip-to-ring) and longitudinal (tip-to-ground and ring-to-ground) protection. For analog signals, the PP3100SB/SC is recommended. With a resistance value of 15 Ohms for the tip and ring resistors, the PP3100SA may be used. The National Electric Code (NEC) article 800 requires two fuse elements when connecting to ground. Fuses or a suitable Positive Temperature Coefficient (PTC) automatic resettable current limiting device may be used. This circuit is recommended for protection against the Bellcore requirement: First Level Lightning Surge Tests (Telecommunications Port), document # GR-1089-CORE.

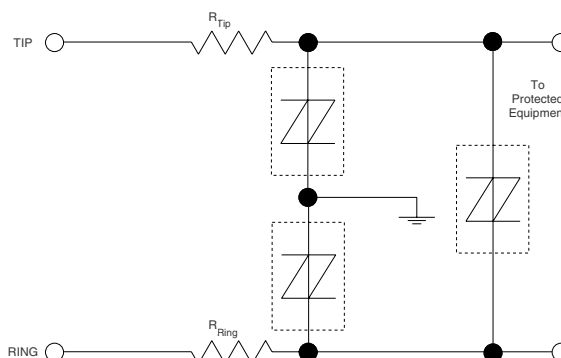

FIGURE 3 - Metallic & Longitudinal Protection

PP0640SA thru PP3500SC

DO-214AA PACKAGE OUTLINE & DIMENSIONS

PACKAGE OUTLINE

The technical drawing shows two views of the DO-214AA package. The top view shows a rectangular package with dimensions A (height), B (width), and C (length). The side view shows the package's profile with dimensions D (total height), E (lead height), F (lead length), G (lead thickness), and H (lead width).

DO-214AA (SMB)

DIMENSIONS

DIM	MILLIMETERS		INCHES	
	MIN	MAX	MIN	MAX
A	1.96	2.21	0.077	0.087
B	3.30	3.94	0.130	0.155
C	4.06	4.57	0.160	0.180
D	2.00	2.50	0.079	0.098
E	0.76	1.52	0.030	0.060
F	5.21	5.59	0.205	0.220
G	0.10	0.20	0.004	0.008
H	0.15	0.31	0.006	0.012

NOTES

- Dimensions are exclusive of mold flash and metal burrs.

TAPE & REEL ORDERING NOMENCLATURE

- Surface mount product is taped and reeled in accordance with EIA-481.
- Suffix-T = 13 Inch Reel - 3,000 pieces per 12mm tape, i.e., PP0640SA-T.
- Suffix - LF = Lead-Free, Pure-Tin Plating, .e., PP0640SA-LF-T.

Outline & Dimensions: Rev 0 - 4/02, 06030

COPYRIGHT © ProTek Devices 2007

SPECIFICATIONS: ProTek reserves the right to change the electrical and or mechanical characteristics described herein without notice (except JEDEC).

DESIGN CHANGES: ProTek reserves the right to discontinue product lines without notice, and that the final judgement concerning selection and specifications is the buyer's and that in furnishing engineering and technical assistance, ProTek assumes no responsibility with respect to the selection or specifications of such products.

ProTek Devices
2929 South Fair Lane, Tempe, AZ 85282
Tel: 602-431-8101 Fax: 602-431-2288
E-Mail: sales@protekdevices.com
Web Site: www.protekdevices.com