

# MB3829

## System Power Supply IC for Mobile Telephone

### DESCRIPTION

This power supply IC incorporates a 4-channel series regulator and a battery backup function. It is a multi-function power supply IC with an output control function and momentary power-loss detection circuit, which are both required for mobile telephones. It also incorporates a speaker amplifier and a buzzer driver. Since it has a built-in power system suitable for mobile telephones, it promises equipment downsizing.

### FEATURES

- Power consumption during standby : 0.22 mW (typ.)
- 4-channel low-saturation voltage type series regulator : 6  $\Omega$  typ. for channels 1-3  
20  $\Omega$  typ. for channel 4
- Battery backup function
- Momentary power-loss and power-restoration functions
- ON/OFF switch circuit with an operating error prevention function
- BTL amplifier for driving the speaker : Output power= 90 mW typ.
- Buzzer driver to permit changing the sound volume : 200 mA max.
- Power supply voltage drops are accurately detected.
- Hysteresis is provided for detection voltage.
- Watchdog timer stop function is provided (inhibit pin).
- Watchdog monitoring time and reset time are set independently.

### 48-PIN PLASTIC LQFP (FPT-48P-M05)

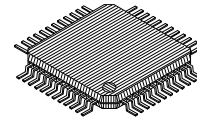

This device contains circuitry to protect the inputs against damage due to high static voltages or electric fields. However, it is advised that normal precautions be taken to avoid application of any voltage higher than maximum rated voltages to this high impedance circuit.

# PIN ASSIGNMENT

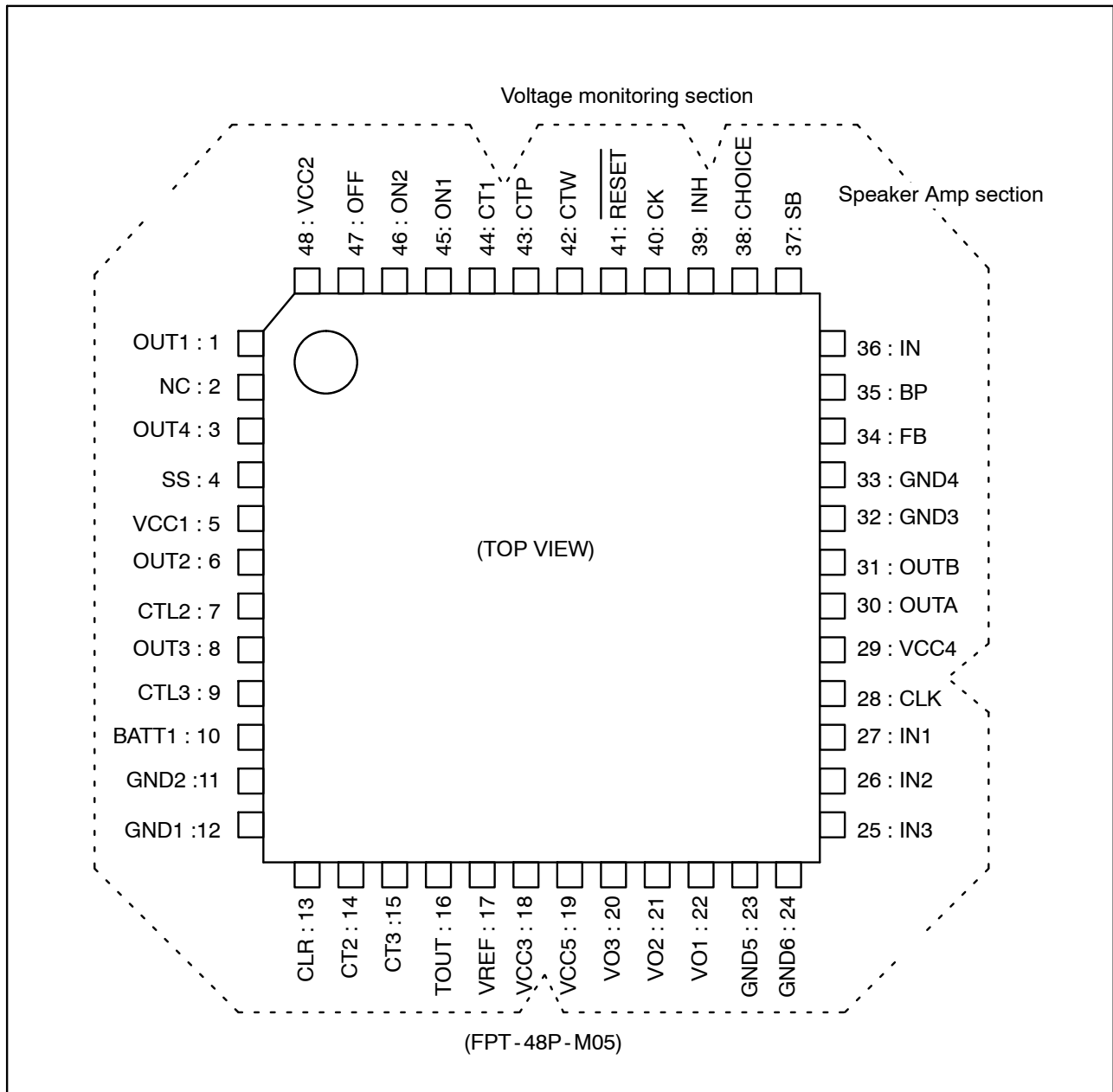

## PIN DESCRIPTION

Pin No.	Pin Symbol	I/O	Description	
Power supply control section	1	OUT1	O	REG1 output pin (3.0 V)
	2	NC	-	Unconnected pin (open)
	3	OUT4	O	REG4 output pin (3.0 V)
	4	SS	-	VREF slow-start capacitance connection pin
	5	VCC1	-	Power supply pin for power supply control section
	6	OUT2	O	REG2 output pin (3.0 V)
	7	CTL2	I	REG2 control pin In REG1 operating H level: REG2 operation; L level: REG2 OFF
	8	OUT3	O	REG3 output pin (3.0 V)
	9	CTL3	I	REG3 control pin In REG1 operating H level: REG3 operation; L level: REG3 OFF
	10	BATT1	-	Backup battery connection pin
	11	GND2	-	Ground pin
	12	GND1	-	Ground pin
	13	CLR	I	Reset pin for momentary power - loss detection and power - restoration section
	14	CT2	-	Pin for connecting momentary power - loss evaluation time setup capacitor
	15	CT3	-	Pin for connecting momentary power - loss evaluation time setup capacitor and resistor
	16	TOUT	O	Pin for momentary power - loss detection and output (open drain)
	17	VREF	O	Pin for reference voltage output
	18	VCC3	-	Power supply pin for momentary power - loss detection and power - restoration section
Sounder section	19	VCC5	-	Power supply pin for sounder section
	20	VO3	O	Output 3 pin (open collector)
	21	VO2	O	Output 2 pin (open collector)
	22	VO1	O	Output 1 pin (open collector)
	23	GND5	-	Ground pin
	24	GND6	-	Ground pin
	25	IN3	I	Control input 3 pin (H level: VO3 operation)

(Continue)

**MB3829***(Continued)*

Pin No.	Pin Symbol	I/O	Description	
Sounder section	26	IN2	I	Control input 2 pin (H level: Vo2 operation)
	27	IN1	I	Control input 1 pin (H level: Vo1 operation)
	28	CLK	I	Clock input pin
Speaker amplifier section	29	VCC4	-	Power supply pin for speaker amplifier section
	30	OUTA	O	Output A pin
	31	OUTB	O	Output B pin
	32	GND3	-	Ground pin
	33	GND4	-	Ground pin
	34	FB	I	Inverted input pin
	35	BP	-	Bypass pin
	36	IN	I	Non-inverted input pin
	37	SB	I	Control input pin (H level: speaker amplifier operation)
	38	CHOICE	-	Earphone selection control pin
Voltage monitoring section	39	INH	I	Inhibit pin
	40	CK	I	Clock input pin
	41	RESET	O	Reset output pin
	42	CTW	-	Pin for watchdog timer monitoring time setup
	43	CTP	-	Pin for power-on reset hold time setup
Power supply control section	44	CT1	-	Pin for connecting ON time setup capacitor
	45	ON1	I	ON1 pin
	46	ON2	I	ON2 pin
	47	OFF	I	OFF pin
	48	VCC2	-	Power supply pin for ON/OFF switch section

# BLOCK DIAGRAM

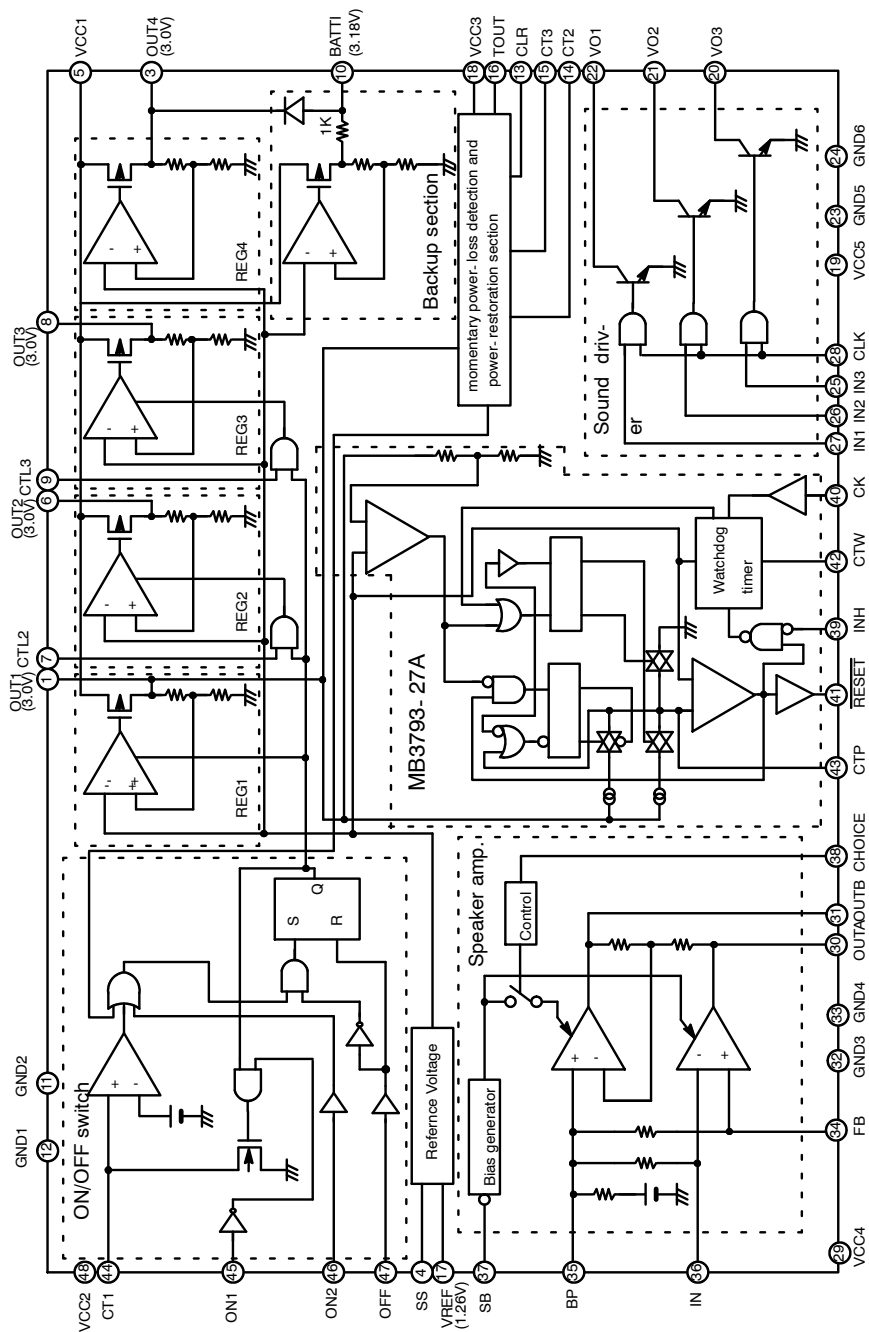

## Function Descriptions

### 1. Power supply control section

#### (1) Reference voltage circuit

The reference voltage circuit generates a temperature-compensated, stable voltage ( $\approx 1.26$  V). The generated reference voltage is used as the power supply control section reference voltage or bias.

#### (2) Series regulator section

A 4-channel series regulator incorporating a low-saturation output transistor is used. All four channels provide an output voltage of 3.0 V. Their characteristics are described below.

REG1 is suitable for a microcontroller power supply because it is connected to a power-on reset circuit. It is controlled by the ON/OFF switch section.

ON/OFF control of REG2 and REG3 is exercised independently by the CTL2 and CTL3 pins while REG1 is ON.

REG4 operates at all times and is therefore suitable for data backup.

REGs 1 through 4 incorporate an overcurrent-protection circuit (REG1 to REG3  $\approx -100$  mA, REG4  $\approx -25$  mA).

#### (3) Battery backup section

When the main battery is installed, the series regulator recharges a button-type lithium secondary battery, which is often used to provide backup for clocks and memory. When the main battery is not installed, the backup battery supplies power to clocks and the battery via a built-in diode. Since the recharging series regulator is set at 3.18 V, this battery backup section is suitable for manganese and lithium batteries.

#### (4) ON/OFF switch section

When a time-setup capacitance and resistance are connected to the CT1 pin, the ON1 pin makes it possible to set the power supply button activation time. This feature prevents turning ON a mobile telephone accidentally.

The ON2 and OFF pins provide a method of exercising direct ON/OFF control of the regulator.

ON time setting calculation formula:  $T_{ON} \approx -C_{T1} \times R_{T1} \times \ln(1 - 1.26V/V_{CC2})$

#### (5) Momentary power-loss function and power-restoration section

When a time-setup capacitance and resistance are connected to the CT3 pin, a momentary Vcc loss, which may be caused by battery replacement, etc., will be detected so as to deliver output to the TOUT pin. At power restoration, the operating state before the momentary power loss is recovered.

After a momentary power loss, the CLR pin resets the prevailing state so that the momentary power-loss detection circuit retains the latch circuit state.

Momentary power-loss detection time calculation formula:  $T_{OFF} \approx -C_{T3} \times R_{T3} \times \ln(1 - (2.3V - 0.27V)/2.3V)$

**(6) ON/OFF setup conditions for individual channels**

ON/OFF switching section		CTL2	CTL3	REG1	REG2	REG3	REG4	Battery backup
ON2	OFF							
L	H	x	x	OFF (standby mode)			ON	ON
H	L	L	L	ON	OFF	OFF		
		H	L		ON	OFF		
		L	H		OFF	ON		
		H	H		ON	ON		

**2. Speaker amplifier section**

A BTL - output type amplifier is used to drive the speaker directly. The typical output power is as high as 90 mW (at 32 Ω), and the SB pin provides ON/OFF control.

The CHOICE pin controls earphone selection.

**3. Sounder section**

This section incorporates three low - saturation output transistors for driving the buzzer. IN1, IN2, and IN3 are used to select the output transistor.

**4. Voltage monitoring section**

This section incorporates the REG1 output voltage detection function and watchdog timer function. It outputs a reset signal to the RESET pin. Further, the detection time varies with the capacitance connected to the CTP and CTW pins.

## ABSOLUTE MAXIMUM RATINGS

Parameter		Symbol	Condition	Value	Unit
Common to all sections	Power-supply voltage	$V_{CC}$		10	V
	Power dissipation	$P_D$	$T_A \leq +25^\circ\text{C}$	860*	mW
	Storage temperature	Tstg		-50 to +125	$^\circ\text{C}$
Power supply control section	Output current	$I_{O1}$ to $I_{O3}$		-60	mA
		$I_{O4}$		-12	mA
Speaker amplifier section	Output current	$I_O$		150	mA
Sounder section	Output current	$I_{O1}$	Duty = 50%	240	mA
		$I_{O2}$	Duty = 50%	120	mA
		$I_{O3}$	Duty = 50%	60	mA
Voltage monitoring section	Reset output current	$I_{OL}, I_{OH}$	DC	-10 to 10	mA

\*: Value as mounted on double-sided epoxy board 10 × 10 cm

**NOTE:** Permanent device damage may occur if the above **Absolute Maximum Ratings** are exceeded. Functional operation should be restricted to the conditions as detailed in the operational sections of this data sheet. Exposure to absolute maximum rating conditions for extended periods may affect device reliability.

## RECOMMENDED OPERATING CONDITIONS(1)

Parameter	Symbol	Condition	Value			Unit
			Min.	Typ.	Max.	
Common to all sections	Power supply voltage	$V_{CC}$	3.49		8.0	V
	Power supply voltage buildup time	$T_{V_{CC}}$	50			$\mu\text{S/V}$
	Operation temperature	$T_A$	-30	25	85	$^\circ\text{C}$



## RECOMMENDED OPERATING CONDITIONS(2)

Parameter	Symbol	Condition	Value			Unit		
			Min.	Typ.	Max.			
Power supply control section	Control input voltage	$V_I$		0		$V_{CC}$	V	
	Output current	$I_{O1}$ to $I_{O3}$		-50			mA	
		$I_{O4}$		-10			mA	
	Backup current	$I_{BATT1}$				200	$\mu$ A	
	CLR input pulse width	$T_{CLR}$		200			ns	
	OFF input pulse width	$T_{OFF}$	CT3 = 2.2 $\mu$ F, RT3 = 1M $\Omega$	10			ms	
	ON2 input pulse width	$T_{ON2}$		10			$\mu$ s	
	ON setting time setup	Capacitance	$C_{T1}$		1.5			$\mu$ F
		Resistance	$R_{T1}$		1			M $\Omega$
Momentary power-loss time setup	Capacitance	$C_{T3}$		2.2			$\mu$ F	
	Resistance	$R_{T3}$		1			M $\Omega$	
Speaker amplifier section	Control input voltage	$V_I$		0		$V_{CC}$	V	
	Amplifier input voltage	$V_{IN}$		0.3		$V_{CC}-0.8$	V	
	Load resistance	$R_L$		8	32	200	$\Omega$	
	Gain setting range	AV	When Non-INV input	6	24	36		dB
			When INV input	-26	-20	36		dB
Sounder section	Control input voltage	$V_I$		0		$V_{CC}$	V	
	Output current	$I_{O1}$	Duty = 50%			200	mA	
		$I_{O2}$	Duty = 50%			100	mA	
		$I_{O3}$	Duty = 50%			50	mA	
Voltage monitoring section	RESET output current	$I_{OL}, I_{OH}$		-3		3	mA	
	Reset/hold time setup capacitance	$C_{TP}$		0.001		10	$\mu$ F	
	Clock monitoring time setup capacitance	$C_{TW}$		0.001		1	$\mu$ F	
	Clock monitoring time setting	$T_{WD}$		0.1		1500	ms	

Note: The recommended operating conditions are the recommended values guaranteeing normal LSI operations. The specified values for electrical characteristics are guaranteed when the conditions in the Condition column, as well as the recommended operating conditions, are met.

## ELECTRICAL CHARACTERISTICS

### 1. Power supply control section

 $(V_{CC1,2,3} = +3.6V, T_A = +25^{\circ}C)$ 

Parameter	Symbol	Condition	Value			Unit		
			Min.	Typ.	Max.			
Reference voltage section	Reference voltage	$V_{REF}$	$I_O=0mA$	1.23	1.26	1.29	V	
Constant Voltage Controller (REG1)	Output voltage	$V_O$	$I_O=0mA$	2.90	3.00	3.13	V	
		$V_O$	$I_O=-50mA$	2.90	3.00	3.13	V	
	Output saturation voltage	$V_{SAT}$	$I_O=-22mA, V_{CC}=3V$		0.15	0.27	V	
	Temperature regulation of output voltage	$\Delta V_O/V_O$	$T_A=-30$ to $+85^{\circ}C$ *		1	2	%	
	Input stability	Line	$V_{CC}=3.49V$ to $8V, I_O=-10mA$		10	50	mV	
	Load stability	Load	$I_O=0mA$ to $-50mA$		10	50	mV	
	Ripple removal ratio	R.R	$V_{IN}=0.2V_{rms},$ $I_O=-10mA$	$f=25Hz$ *	38	50		dB
				$f=1kHz$ *	23	35		dB
Rise time	$T_R$	$C=10\mu F, R=60\Omega$ *		250	410	$\mu s$		
Constant Voltage Controller (REG2,3)	Output voltage	$V_O$	$I_O=0mA$	2.90	3.00	3.13	V	
		$V_O$	$I_O=-50mA$	2.90	3.00	3.13	V	
	Output saturation voltage	$V_{SAT}$	$I_O=-40mA, V_{CC}=3V$		0.25	0.45	V	
	Temperature regulation of output voltage	$\Delta V_O/V_O$	$T_A=-30$ to $+85^{\circ}C$ *		1	2	%	
	Input stability	Line	$V_{CC}=3.49V$ to $8V, I_O=-10mA$		10	50	mV	
	Load stability	Load	$I_O=0mA$ to $-50mA$		10	50	mV	
	Ripple removal ratio	R.R	$V_{IN}=0.2V_{rms},$ $I_O=-10mA$	$f=25Hz$ *	38	50		dB
				$f=1kHz$ *	23	35		dB
	Input-on condition	$V_{ON}$	-	2.0		$V_{CC}$	V	
	Input-off condition	$V_{OFF}$	-	0		0.8	V	
	Input current	$I_{IH}$	$V_I=3.0V$		17	30	$\mu A$	
		$I_{IL}$	$V_I=0.4V$	1	2	3	$\mu A$	
	Rise time	$T_R$	$C=10\mu F, R=60\Omega$ *		250	410	$\mu s$	

\*: Guaranteed by design

( $V_{CC1,2,3} = +3.6V$ ,  $T_A = +25^{\circ}C$ )

Parameter	Symbol	Condition	Value			Unit		
			Min.	Typ.	Max.			
Constant Voltage Controller (REG4)	Output voltage	$V_O$	$I_O=0mA$	2.90	3.00	3.13	V	
		$V_O$	$I_O=-10mA$	2.90	3.00	3.13	V	
	Output saturation voltage	$V_{SAT}$	$I_O=-2mA$ , $V_{CC}=3V$		0.05	0.1	%	
	Temperature regulation of output voltage	$\Delta V_O/V_O$	$T_A=-30$ to $+85^{\circ}C$ *		1	2	mV	
	Input stability	Line	$V_{CC}=3.49V$ to $8V$		10	50	mV	
	Load stability	Load	$I_O=0mA$ to $-10mA$		10	50	dB	
	Ripple removal ratio	R.R	$V_{IN}=0.2V_{rms}$ , $I_O=-2mA$	$f=25Hz$ *	38	50		dB
				$f=1kHz$ *	4	16		V
	Output leakage current	$I_{LEAK}$	$V_{CC1}=0$ to $2.97V$ , $V_{BATT1}=0V$ , $V_{O4}=3V$		1.2	10	$\mu A$	
Rise time	$T_R$	$C=10\mu F$ , $R=300\Omega$ , $SS=1nF$ *		900	1450	$\mu s$		
Backup Section	Output voltage	$V_{BATT1}$	$I_{BATT1}=0\mu A$	3.10	3.18	3.25	V	
	Charging current	$I_{BATT1}$	$V_{BATT1}=2.0V$		-1.18	-0.59	mA	
	Output saturation voltage	$\Delta V_O$	$V_{CC1}=0V$ , $I_{O4}=-20\mu A$	0.52	0.57	0.62	V	
	Output leakage current	$I_{LEAK}$	$V_{CC1}=0$ to $2.97V$ , $V_{BATT1}=3V$ , $V_{O4}$ : Short-circuited to $V_{BATT1}$		2.1	10	$\mu A$	
ON/OFF switch section	Input-on condition	$V_{ON}$	-	2.0		$V_{CC}$	V	
	Input-off condition	$V_{OFF}$	-	0		0.8	V	
	Input current	$I_{IH}$	$V_I=3.0V$		17	30	$\mu A$	
		$I_{IL}$	$V_I=0.4V$	1	2	3	$\mu A$	
	Threshold voltage	$V_{TH}$	CT1 pin *	1.21	1.26	1.31	V	
	CT3 output resistance	$R_{ON}$	OFF=H	0.5	1	1.5	$k\Omega$	
	ON setup time	$T_{ON}$	CT1=1.5 $\mu F$ , RT1=1M $\Omega$	550	650	750	ms	

\*: Guaranteed by design

( $V_{CC1,2,3} = +3.6V$ ,  $T_A = +25^\circ C$ )

Parameter	Symbol	Condition	Value			Unit	
			Min.	Typ.	Max.		
Instantaneous Detection/ Power Restoration Section	Detection voltage	$V_{THL}$	 $V_{CC}$ pin	1.90	2.2	2.5	V
	Instantaneous detection time	$T_{OFF}$	CT3=2.2 $\mu$ F, RT3=1M $\Omega$	4.0	4.7	5.5	s
	Input - on condition	$V_{ON}$	CLR pin	2.0		$V_{CC}$	V
	Input - off condition	$V_{OFF}$	CLR pin	0		0.8	V
	Input current	$I_{IH}$	$V_I=3.0V$		17	30	$\mu$ A
			$V_I=0.4V$	1	2	3	$\mu$ A
	Output leakage current	$I_{LEAK}$	$V_{CC1,2,3} = V_O=8V$			10	$\mu$ A
Output saturation voltage	$V_{SAT}$	$I_O=100\mu A$		0.1	0.3	V	
Power supply control section	Stand - bycurrent	$I_{CC1}$	REG1 to REG3 : OFF $I_{O4} = -100\mu A$ $I_{BATT1} = -200\mu A$		60	90	$\mu$ A
	Power - off current	$I_{CC2}$	REG2,3 : OFF $I_{O1} = -11mA$ , $I_{O4} = -100\mu A$ $I_{BATT1} = -200\mu A$		160	240	$\mu$ A
	Power - oncurrent	$I_{CC3}$	REG3 : OFF $I_{O1} = -11mA$ , $I_{O2} = -30\mu A$ $I_{O4} = -100\mu A$ $I_{BATT1} = -200\mu A$		190	280	$\mu$ A
	Power - oncurrent	$I_{CC4}$	$I_{O1} = -11mA$ , $I_{O2} = -40mA$ $I_{O3} = -12mA$ , $I_{O4} = -100\mu A$ $I_{BATT1} = -200\mu A$		360	530	$\mu$ A
	Power - oncurrent	$I_{CC5}$	$I_{O1}$ to $I_{O4}$ , $I_{BATT1}$ : No load		160	240	$\mu$ A

Note: The  $I_{CC1}$  to  $I_{CC5}$  values for the whole power supply control section represent the sum of  $V_{CC1}$  to  $V_{CC3}$  pin current values except the load current.

## 2. Speaker amplifier section

( $V_{CC1,2,3} = +3.6V$ ,  $T_A = +25^\circ C$ )

Parameter	Symbol	Condition	Value			Unit	
			Min.	Typ.	Max.		
Speaker amplifier section	Voltage gain	$A_V$	Non-INV input	22	24	26	dB
	Release voltage gain	$A_{VO}$	$f \leq 100 \text{ Hz}$ *		80		dB
	Output power	$P_D$	$R_L = 32 \Omega$ , THD = 10 %	60	90		mW
	Output voltage	$V_O$	No load	3.8	5.5		V
	Offset voltage between output	$V_{OO}$	-	-50		50	mV
	Distortion rate of all high frequencies	THD	$P_O \geq 25 \text{ mW}$		0.5	1.0	%
	Ripple extraction ratio	PSRR	- *	33	45		dB
	Rise time	$T_R$	$P_O \geq 25 \text{ mW}$ , BP=4.7 $\mu$ F *			0.25	s
Earphone	Voltage gain	$A_{VI}$	-	16	18	20	dB
	Output voltage	$V_{OI}$	No load	1.4	2.75		V
	Rise time	$T_R$	$P_O \geq 6 \text{ mW}$ , BP=4.7 $\mu$ F *			0.25	s
Input impedance	$R_{IN}$	-	20	30	50	k $\Omega$	
Input-ON condition	$V_{ON}$	-	2.0		$V_{CC}$	V	
Input-OFF condition	$V_{OFF}$	-	0		0.8	V	
Input current	$I_{IH}$	$V_{SB}=3.0V$		17	30	$\mu$ A	
	$I_{IL}$	$V_{SB}=0.4V$		0	1	$\mu$ A	
Power-supply current at standby	$I_{CC1}$	-		0	10	$\mu$ A	
Power-supply current at no load (Speaker mode)	$I_{CC2}$	When no signal		3	5	mA	
Power-supply current at no load (Earphone mode)	$I_{CC3}$	When no signal		1.5	2.5	mA	
Speaker ON condition	$V_{SON}$	-	0		0.8	V	
Earphone ON condition	$V_{EON}$	-	2.0		$V_{CC}$	V	

\*: Guaranteed by design

### 3. Sounder

(V<sub>CC5</sub> = +3.6V, T<sub>A</sub> = +25°C)

Parameter	Symbol	Condition	Value			Unit
			Min.	Typ.	Max.	
Output voltage	V <sub>O1</sub>	I <sub>O1</sub> = 200 mA		0.3	0.5	V
	V <sub>O2</sub>	I <sub>O2</sub> = 100 mA		0.3	0.5	V
	V <sub>O3</sub>	I <sub>O3</sub> = 50 mA		0.3	0.5	V
Output leakage current	I <sub>LEAK</sub>	V <sub>CC1,2,3</sub> = V <sub>O</sub> = 8 V			10	μA
Input - ON condition	V <sub>ON</sub>	-	2.0		V <sub>CC</sub>	V
Input - OFF condition	V <sub>OFF</sub>	-	0		0.8	V
Input current	I <sub>IH</sub>	V <sub>I</sub> = 3.3 V		34	60	μA
	I <sub>IL</sub>	V <sub>I</sub> = 0.4 V	2	4	6	μA
Power - supply current at standby	I <sub>CC1</sub>	-		2	10	μA
Power - supply current at no load	I <sub>CC2</sub>	V <sub>IN1</sub> = 3.0 V, CLK Duty = 50%		3.0	4.5	mA
	I <sub>CC3</sub>	V <sub>IN2</sub> = 3.0 V, CLK Duty = 50%		1.5	2.3	mA
	I <sub>CC4</sub>	V <sub>IN3</sub> = 3.0 V, CLK Duty = 50%		0.8	1.2	mA

## 4. Voltage monitoring section

(OUT1 = +3.0V, T<sub>A</sub> = +25°C)

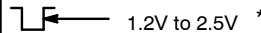
Parameter	Symbol	Condition	Value			Unit
			Min.	Typ.	Max.	
Detection voltage	V <sub>SL</sub>	OUT1 fall	2.70	2.75	2.81	V
	V <sub>SH</sub>	OUT1 rise	2.76	2.81	2.87	V
Detection voltage hysteresis width	V <sub>SHYS</sub>	V <sub>SH</sub> - V <sub>SL</sub>	35	65	95	mV
CK input threshold voltage	V <sub>CIH</sub>	-	0.6	1.2	1.8	V
	V <sub>CIL</sub>	-	0.4	0.9	1.4	V
CK input hysteresis width	V <sub>CHYS</sub>	-	0.1	0.3	0.6	V
Inhibit input voltage	V <sub>I IH</sub>	-	1.8			V
	V <sub>I IL</sub>	-			0.8	V
Input current	CK IHB	I <sub>INH</sub>	V <sub>IN</sub> = OUT1	0	1.0	μA
		I <sub>INL</sub>	V <sub>IN</sub> = GND	-1.0	0	μA
Reset output voltage	V <sub>OH</sub>	$\overline{\text{RESET}}$ = -3mA	2.5	2.8		V
	V <sub>OL</sub>	$\overline{\text{RESET}}$ = +3mA		0.12	0.4	V
Reset output minimum voltage	V <sub>CCL</sub>	$\overline{\text{RESET}}$ = +50μA		0.8	1.2	V
Power-on reset hold time	t <sub>PR</sub>	C <sub>TP</sub> = 0.1μF	25	70	115	ms
Watchdog timer monitoring time	t <sub>WD</sub>	C <sub>TW</sub> =0.01μF, C <sub>TP</sub> =0.1μF	8	16	24	ms
Watchdog timer reset time	t <sub>WR</sub>	C <sub>TP</sub> = 0.1μF	1.5	5	8.5	ms
Clock input pulse width	t <sub>CKW</sub>	- *	500			ns
Clock input pulse cycle	t <sub>CKT</sub>	- *	20			μs
$\overline{\text{RESET}}$ rise time	t <sub>r</sub> *1	C <sub>L</sub> = 50pF *	2.0		500	ns
RESET fall time	t <sub>r</sub> *1	C <sub>L</sub> = 50pF *			500	ns
Delay time from OUT1	T <sub>PD</sub>	- *		2	20	μs
OUT1 input pulse width	T <sub>PI</sub>	 1.2V to 2.5V *	16			μs

\*1: The voltage range prevailing during RESET output rise/fall time measurement is from 10% to 90%

\*: Guaranteed by design

## TYPICAL CHARACTERISTICS CURVE

Allowable dissipation vs. ambient temperature curve

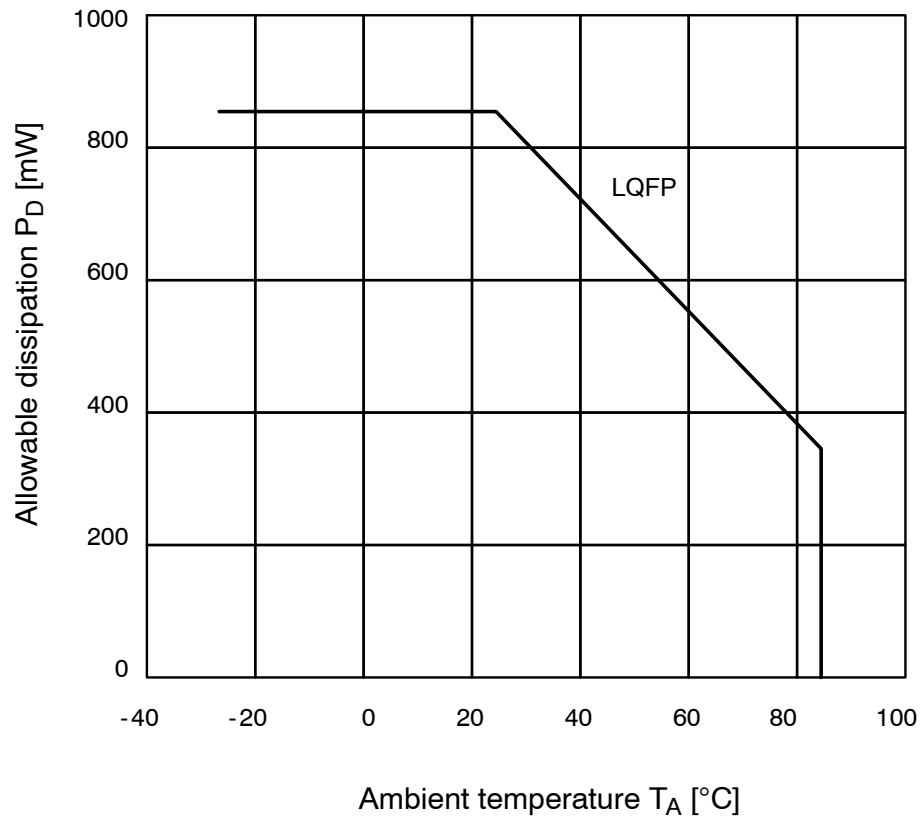



## VOLTAGE MONITORING SECTION TIMING CHART

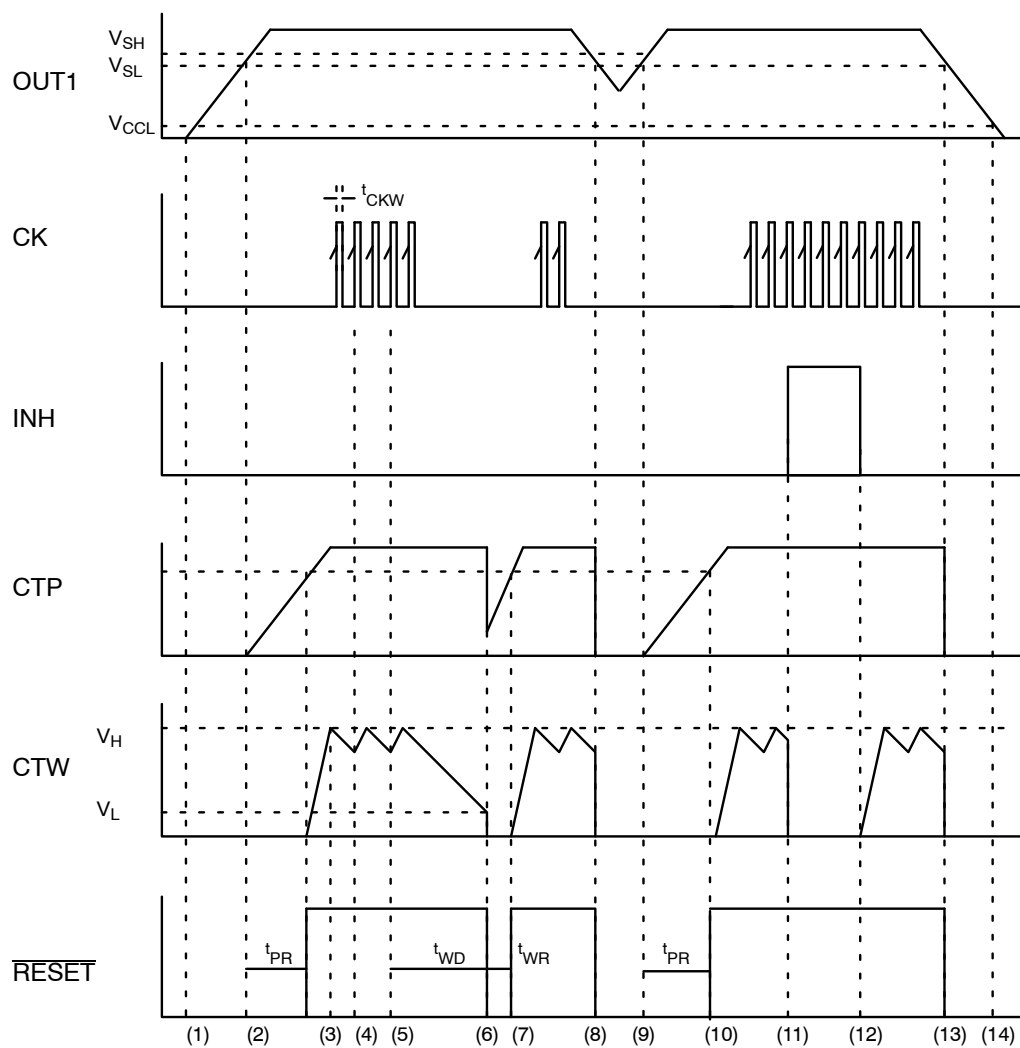

## DESCRIPTION OF OPERATION

(The numbers in the timing diagram correlate to the numbers (1) to (13) below.)

- (1) When the REG1 output voltage (OUT1) is about 0.8 V ( $V_{CCL}$ ), the reset signal is output.
- (2) When OUT1 reaches a level higher than the detection voltage ( $V_{SH}$ ), the power-on reset/hold time setup capacitor ( $C_{TP}$ ) begins to charge. The  $V_{SH}$  value is 2.81 V.
- (3) When the power-on reset/hold time setup pin ( $C_{TP}$ ) voltage rises above the threshold level ( $V_{th}$ ), the reset clears (RESET pin voltage changes from L level to H level). The  $V_{th}$  value is about 1.9 V. The power-on reset/hold time ( $t_{PR}$ ) is expressed by the following equation. Also, the watchdog timer monitoring time setup capacitor ( $C_{TW}$ ) begins to charge.

$$t_{PR} [\text{ms}] \approx A \times C_{TP} [\mu\text{F}]$$

$$A \approx 700$$

- (4) When the watchdog timer monitoring time setup pin ( $C_{TW}$ ) voltage reaches the Hi level ( $V_H$ ), the  $C_{TW}$  changes from the charged state to the discharged state. The  $V_H$  value is about the reference voltage of 1.24 V.
- (5) When a clock pulse input is applied to the clock pin (CK) and then the next clock pulse input is applied (positive edge trigger) to the CK pin during a  $C_{TW}$  discharge, switching from the discharged state to the charged state occurs.
- (6) If a clock pulse input is not delivered to the clock pin (CK) within the watchdog timer monitoring time ( $t_{WD}$ ), the  $C_{TW}$  pin voltage falls below the Lo level ( $V_L$ ) so the reset signal is output (RESET pin voltage changes from H level to the L level). The  $V_L$  value is about 0.24 V. The watchdog timer monitoring time ( $t_{WD}$ ) is expressed by the following equation.

$$t_{WD} [\text{ms}] \approx B \times C_{TW} [\mu\text{F}]$$

$$B \approx 1600$$

- (7) When the  $C_{TP}$  is recharged to raise the  $C_{TP}$  pin voltage above  $V_{th}$ , the reset clears, allowing the watchdog timer to start running. The watchdog timer monitoring reset time ( $t_{WR}$ ) is expressed by the following equation.

$$t_{WR} [\text{ms}] \approx D \times C_{TP} [\mu\text{F}]$$

$$B \approx 50$$

- (8) When the OUT1 drops below the fall period detection voltage ( $V_{SL}$ ), the  $C_{TP}$  pin voltage falls so that the reset signal is output (RESET pin voltage changes from H level to the L level). The  $V_{SL}$  value is about 2.75 V.
- (9) When the OUT1 rises above  $V_{SH}$ ,  $C_{TP}$  charging starts.
- (10) When the  $C_{TP}$  pin voltage rises above  $V_{th}$ , the reset clears, causing the watchdog timer to start running.
- (11) When the inhibit signal is input (Hi level), the watchdog timer operation is forcibly stopped. In this case, only the watchdog timer stops and the OUT1 monitoring operations ((8) to (10)) are performed. If the inhibit input does not clear, the watchdog timer does not operate.
- (12) When the inhibit input clears (becomes Lo level), the watchdog timer begins to operate.
- (13) When the REG1 output turns OFF and OUT1 falls below  $V_{SL}$ , the reset signal is output.

## REG SECTION RISE TIMING REQUIREMENTS

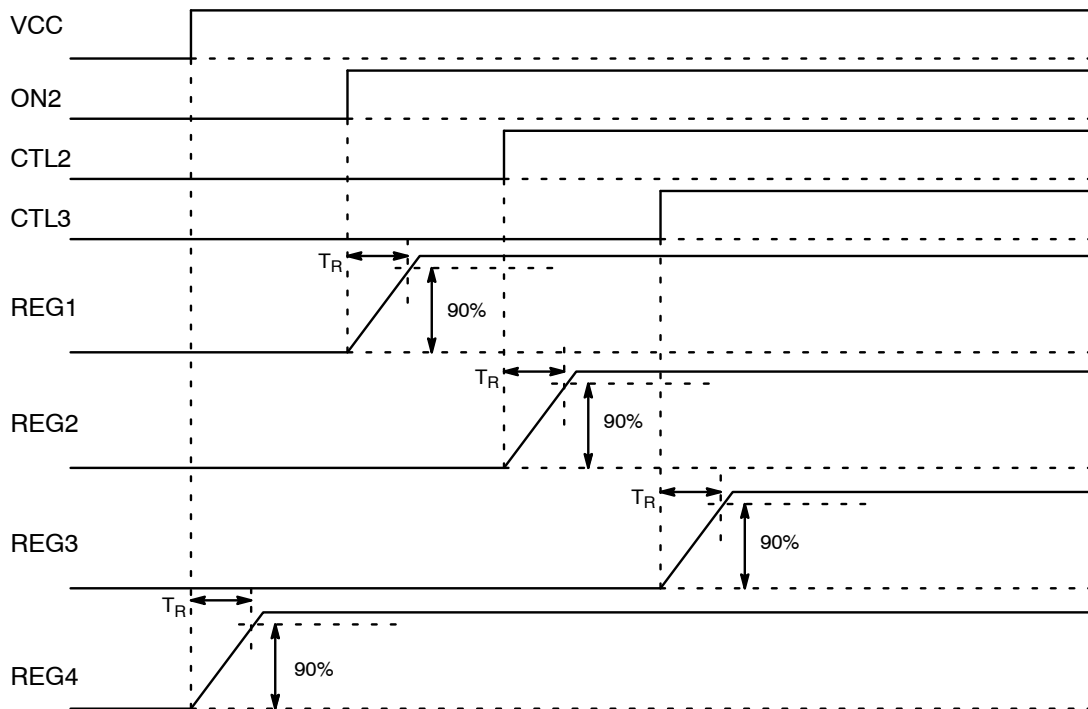

## SPEAKER AMPLIFIER SECTION RISE TIMING REQUIREMENTS

VCC4=VSB CHOICE= L (BP=4.7 $\mu$ F)



Speaker output = 25mW

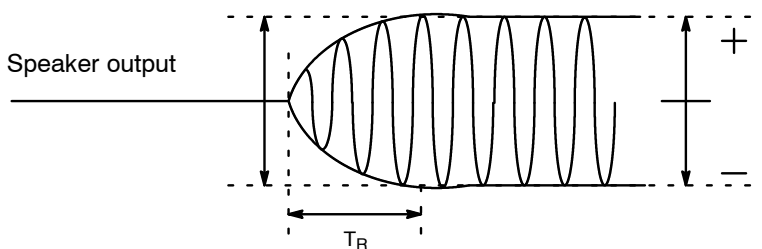

VCC4=VSB =CHOICE (BP=4.7 $\mu$ F)



Earphone output = 6mW

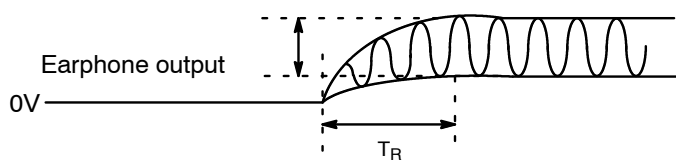

# APPLICATION CIRCUIT

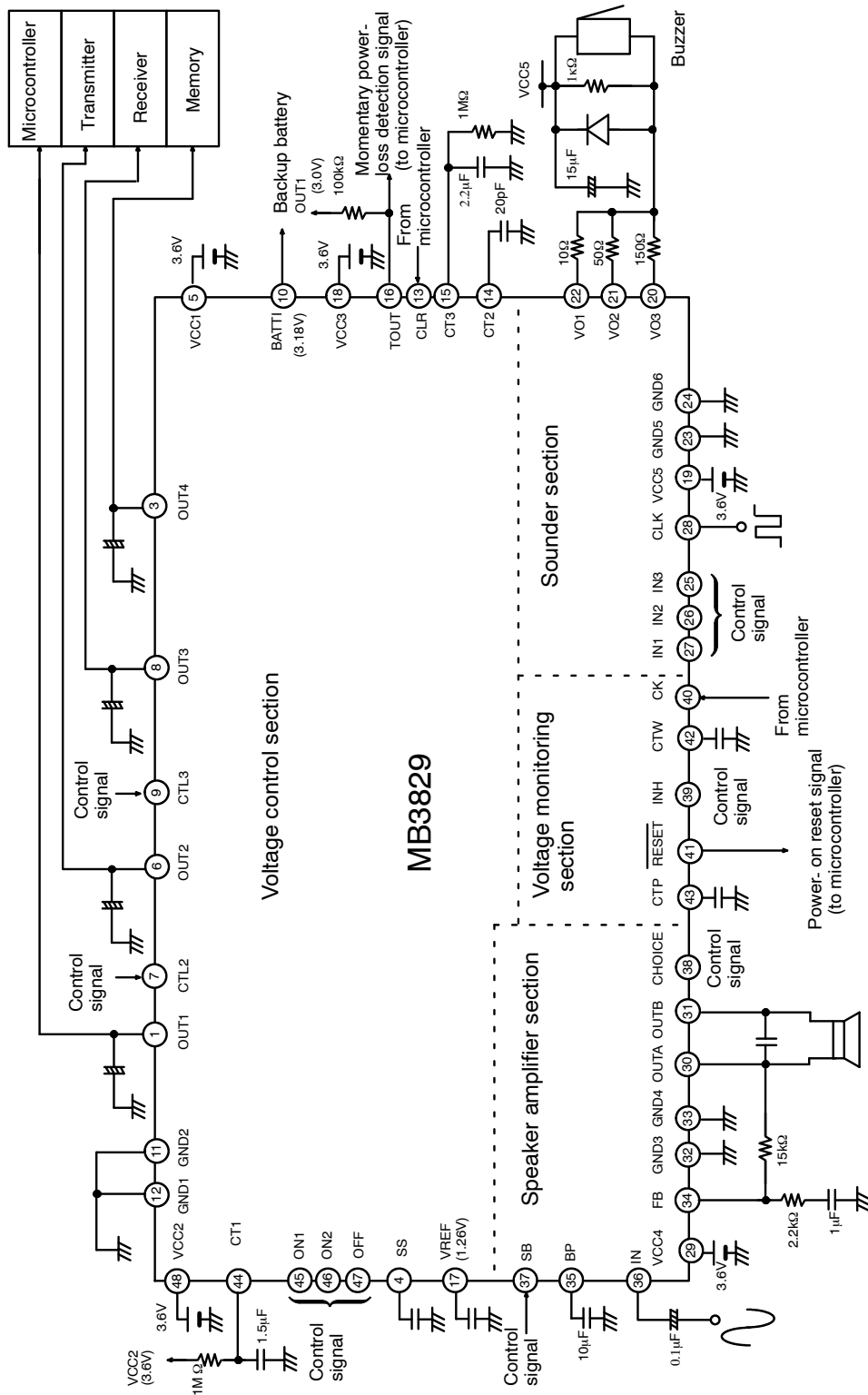

---

## USAGE PRECAUTIONS

### 1. Device settings must not exceed the maximum ratings.

Usage under conditions exceeding absolute maximum ratings may permanently damage LSI devices.

Note also that in normal operation usage within recommended operating conditions is preferred, and that the reliability of LSI devices may be adversely affected when used outside these conditions.

### 2. Devices should be used within recommended operating conditions.

Recommended operating conditions are recommended values within which the LSI device is warranted to operate normally.

Rated values of electrical characteristics are warranted within the range of recommended operating conditions and within the conditions listed in the condition column for each parameter.

### 3. The PC board ground line must be designed by taking the common impedance.

### 4. Guard against static electricity.

The semiconductor containers must be protected against static electricity or made of conductive materials.

When storing or transporting a component-mounted PC board, place it in a conductive bag or container.

Ensure that the workbenches, tools, and measuring instruments are grounded.

Workers must be grounded via a series resistance of 250 k $\Omega$  to 1 M $\Omega$ .

## ORDERING INFORMATION

Part number	Package	Remarks
MB3829PFV-G-BND	Plastic, LQFP, 48-pin (FPT-48P-M05)	

# PACKAGE DIMENSIONS

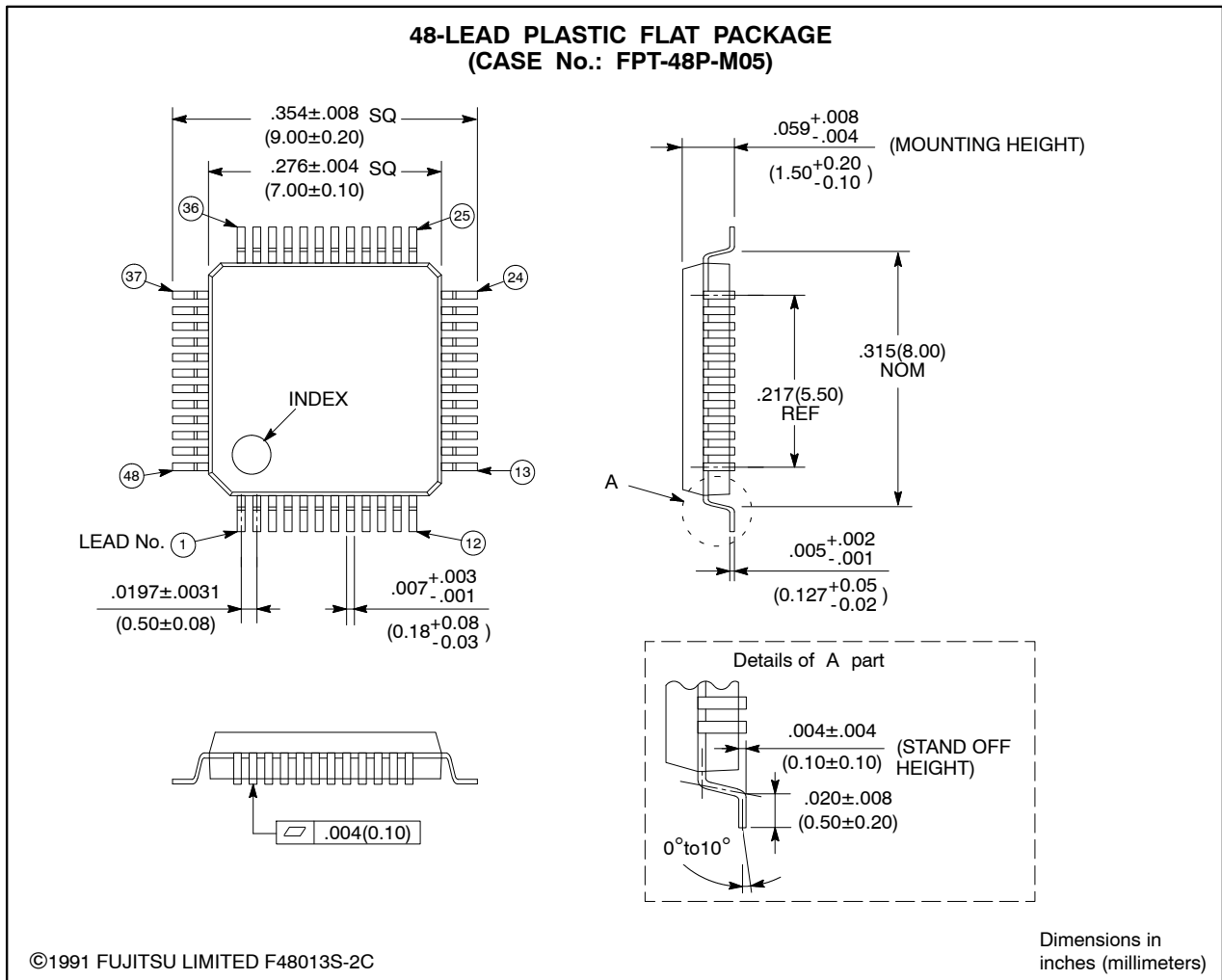

---



**MEMO**

All Rights Reserved.

Circuit diagrams utilizing Fujitsu products are included as a means of illustrating typical semiconductor applications. Complete information sufficient for construction purposes is not necessarily given.

The information contained in this document has been carefully checked and is believed to be reliable. However, Fujitsu assumes no responsibility for inaccuracies.

The information contained in this document does not convey any license under the copyrights, patent rights or trademarks claimed and owned by Fujitsu.

Fujitsu reserves the right to change products or specifications without notice.

No part of this publication may be copied or reproduced in any form or by any means, or transferred to any third party without prior written consent of Fujitsu.

# FUJITSU LIMITED

For further information please contact:

## Japan

FUJITSU LIMITED  
Corporate Global Business Support Div.,  
Electronic Devices  
4-1-1 Kamikodanaka, Nakahara-ku, Kawasaki-shi,  
Kanagawa-ken 211-8588, Japan  
Tel: (044) 754-3763  
FAX: (044) 754-3329

## North and South America

FUJITSU MICROELECTRONICS, INC.  
Integrated Circuits Division  
3545 North First Street  
San Jose, CA 95134-1804, USA  
Tel: (408) 922-9000  
FAX: (408) 922-9179

## Europe

FUJITSU MIKROELEKTRONIK GmbH  
Am Siebenstein 6-10,  
63303 Dreieich-Buchsschlag,  
Germany  
Tel: (06103) 690-0  
FAX: (06103) 690-122

## Asia

FUJITSU MICROELECTRONICS ASIA PTE LIMITED  
#05-08, 151 Lorong Chuan  
New Tech Park  
Singapore 556741  
Tel: (65) 281-0770  
FAX: (65) 281-0220