

Micropower, Universal Supply Voltage Supervisor (SVS)

Features

- Temperature stable 1.0V trigger reference
- User adjustable reset threshold
- User adjustable reset delay time ≥ 25 msec
- Complimentary outputs (RESET, $\overline{\text{RESET}}$)
- Integrated pull-up/down resistors
- Manual reset ($\overline{\text{MR}}$) control input
- Low operating current (40mA typ.)
- 8-lead MSOP and SOIC package

Applications

- Critical power monitoring
- Power-up sequencing
- Memory integrity during "brownouts"

Product Description

The CM3400 is a universal supply voltage supervisory (SVS) controller for critical power monitoring and power sequencing applications. During an initial power-up, both complimentary outputs (RESET, $\overline{\text{RESET}}$) remain active. Once the supply voltage being monitored exceeds the user programmed reset threshold, the outputs will remain active for an additional timeout interval which is also user controlled. Both outputs become inactive once the delay interval has expired.

The user controlled reset threshold is determined by two external resistors as follows:

$$\text{Reset Threshold [V]} = (R_1 + R_2) / R_2$$

The delay time is set by an external capacitor C_T , as follows (where C_T is in [nF]):

$$\text{Reset Delay [ms]} = (375 \times C_T[\text{nF}]) + 25 \text{ [ms]}$$

During a brown-out condition, both outputs will immediately become active and remain active until the supply being monitored has been restored for a period exceeding the delay pulse. During a complete power-down situation, both outputs will continually "hug" their respective rails. This is achieved by the use of integrated pull-up/down resistors.

The CM3400 is available in a low profile MSOP-8 and a SOIC-8 package.

Typical Application Circuit

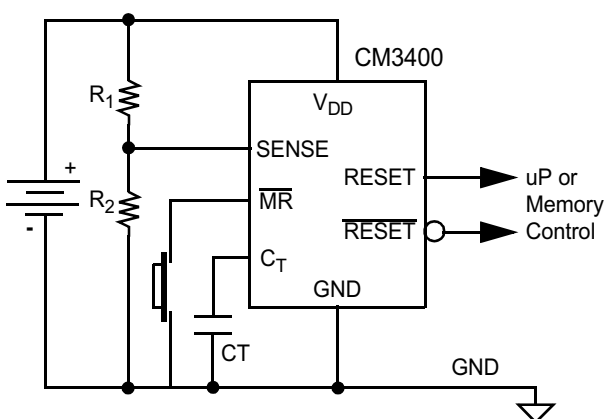

Simplified Electrical Schematic

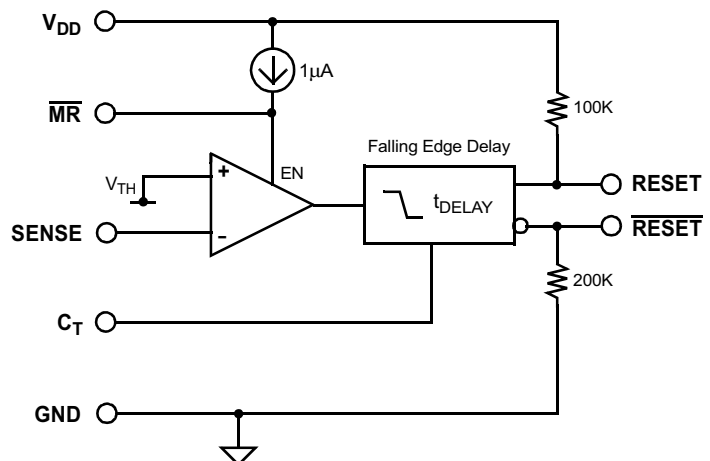

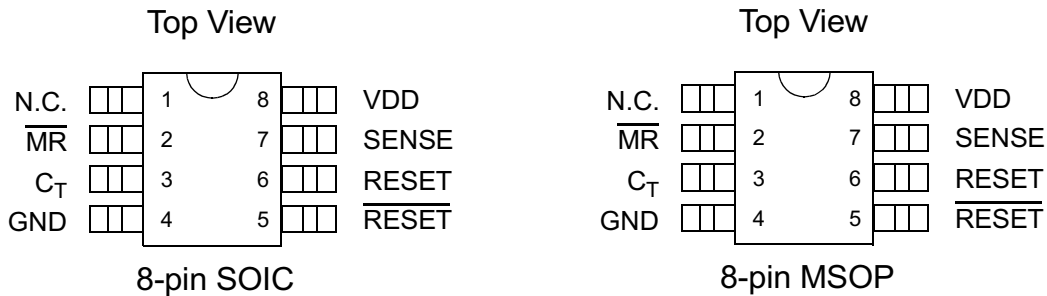
PACKAGE / PINOUT DIAGRAM

Note: This drawing is not to scale.

PIN DESCRIPTIONS

PIN(S)	NAME	DESCRIPTION
1	N.C.	No connect.
2	$\overline{\text{MR}}$	Active-Low manual reset control input. Whenever this input is taken logic low (grounded), the device will immediately force a reset condition. Upon releasing from ground the reset will remain active for the duration of the reset delay timing T_{DELAY} interval. This contains an internal pull-up current source and may be left unconnected if not used.
3	C_T	Capacitor timing control input. The timeout delay interval produced by the external timing capacitor is 25ms/nF. A temperature stable internal current source (0.2 μ A) is used to accurately control the user programmable delay interval. If no external timing capacitor is present, the delay timeout interval is 25ms.
4	GND	Negative reference for all voltages.
5	$\overline{\text{RESET}}$	Active-low reset output. Whenever V_{OUT} falls below the Reset threshold, the logic output immediately is driven low (to GND). Upon V_{OUT} rising above the Reset threshold, the logic output remains low (at GND) for an additional delay time duration T_d , after which it is driven to a logic high level (set by V_{OUT}). The power-on reset circuitry remains enabled under all conditions and produces a valid output logic, even when V_{CC} is not present.
6	RESET	Active-high reset output. Inverse of $\overline{\text{RESET}}$.
7	SENSE	Positive input voltage to the accurate 1.0 volt threshold comparator. Whenever this input is below the trigger threshold (1.0V) both logic outputs are immediately held in their respective Active state. When this input signal rises past the trigger threshold voltage, the delay timer will start and both logic outputs will still remain Active. Once the delay time has been reached both logic outputs will toggle to their respective Inactive state.
8	V_{DD}	Input power source for the device. The device is designed to operate with supply voltage of 2.5V or greater. Whenever the supply voltage is below 2.5V (i.e during power-up / power-down) an internal undervoltage lockout circuit is activated which prevents any false triggering on the RESET logic outputs. This feature ensures the logic outputs will "hug" their respective rail and produce valid outputs under all supply conditions. (Conventional Supervisory circuits can generate undefined output conditions during initial power-up sequences)

Ordering Information

PART NUMBERING INFORMATION			
Pins	Package	Ordering Part Number ²	Part Marking
8	MSOP-8	CM3400-00MS	171CMD
8	SOIC-8	CM3400-00SN	CMPWR171SN

Note 1: Parts are shipped in Tape & Reel form unless otherwise specified.

Specifications

ABSOLUTE MAXIMUM RATINGS		
PARAMETER	RATING	UNITS
ESD Protection (HBM)	±1500	V
Pin Voltages V _{DD} , SENSE, \overline{MR} , C _T Inputs RESET, \overline{RESET} Outputs	[GND - 0.5] to +6.5 [GND - 0.5] to [V _{DD} + 0.5]	V V
Storage Temperature Range	-40 to +150	°C
Operating Temperature Range Ambient	-40 to +125	°C

STANDARD OPERATING CONDITIONS		
PARAMETER	VALUE	UNITS
V _{DD} Supply	2.5 to 5.5	V
SENSE Input	0 to 5.5	V
C _T Timing Capacitor	0 to 3.3	nF
Ambient Operating Temperature Range	0 to +70	°C

Specifications (cont'd)

ELECTRICAL OPERATING CHARACTERISTICS¹						
SYMBOL	PARAMETER	CONDITIONS	MIN	TYP	MAX	UNITS
V_{TH}	SENSE Threshold Trigger Level		0.95	1.00	1.05	V
I_{SENSE}	SENSE Input Bias Current				1	μA
I_{CT}	Timing Current Source		0.10	0.16	0.25	μA
T_{DELAY}	Timing Capacitor Delay (applies to RESET & \overline{RESET} outputs)	C_T not connected (default)	15	25	35	mS
		$C_T = 0.1nF$	35	55	75	mS
		$C_T = 1nF$	225	325	425	mS
I_{GND}	Ground Current	No load.		40	70	μA
t_{PHL}	Propagation Delay When Asserting RESET	$SENSE < (V_{TH} - 50mV)$		0.5	5	μS

RESET Pin

R_{PULLUP}	\overline{RESET} Pull-up Impedance	$V_{DD} < 1.0V$ $V_{DD} > 2.5V$		100 0.5	500 3	$k\Omega$ $k\Omega$
$R_{PULLDOWN}$	\overline{RESET} Pull-down Impedance			0.5	3	$k\Omega$

RESET Pin

$R_{PULLDOWN}$	\overline{RESET} Pull-down Impedance	$V_{DD} < 1.0V$ $V_{DD} > 2.5V$		200 0.5	500 3	$k\Omega$ $k\Omega$
R_{PULLUP}	\overline{RESET} Pull-up Impedance			0.5	3	$k\Omega$

MR Pin

I_{MR}	Internal Pull-up Current		0.5	2	5	μA
$V_{IH MR}$	High Detect Input Level		1.5			V
$V_{IL MR}$	Low Detect Input Level				0.3	V
t_{MR}	Propagation Delay				2	μS

Note 1: Electrical Operating Characteristics are specified over the Standard Operating Conditions unless specified otherwise.



Performance Information

CM3400 Typical Transient Characteristics (nominal conditions unless specified otherwise)

Transient Operation Description ($V_{DD} > 2.5V$)

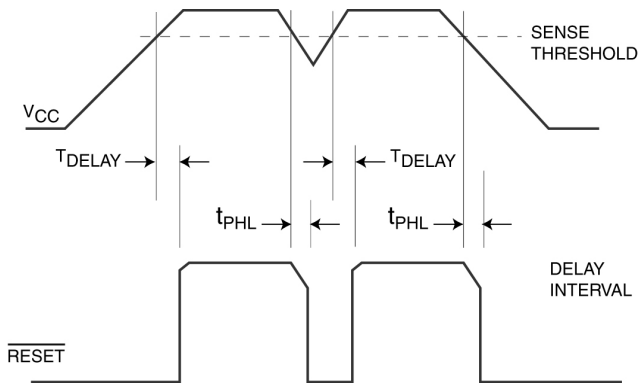

Actual Transient Operation

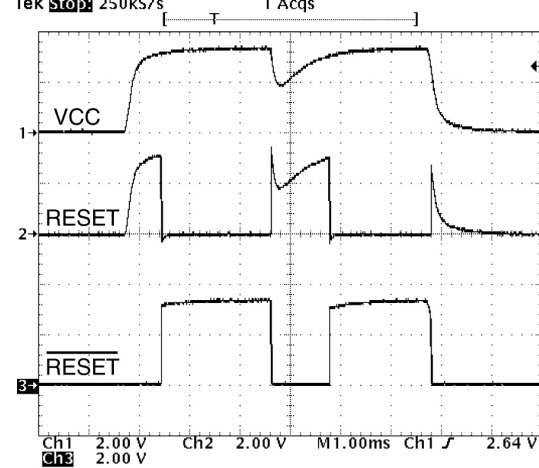

Threshold Trigger Voltage vs. Supply

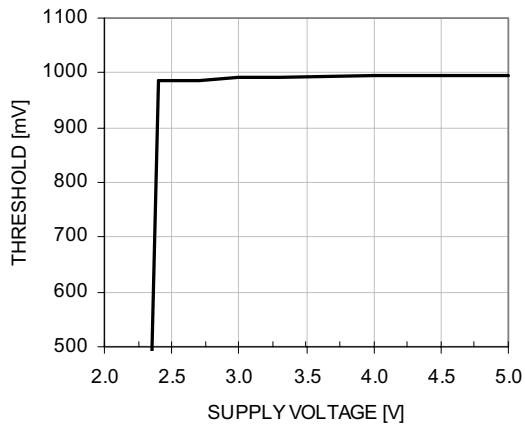

RESET Comparator Response With Overdrive

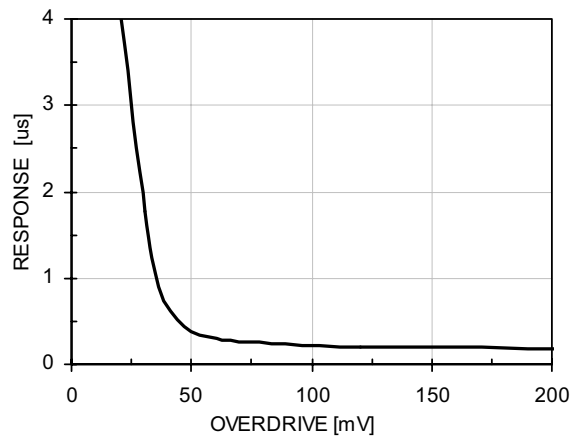

Timeout Delay With CT Capacitance

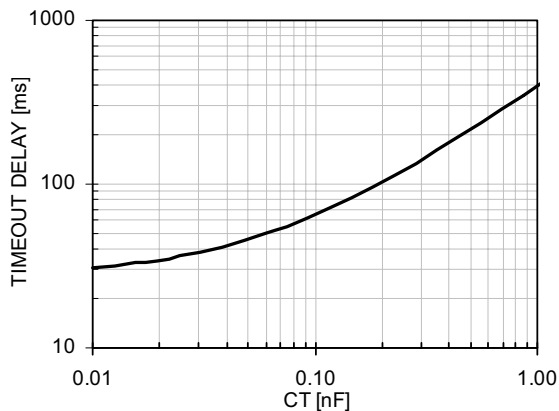



Performance Information (cont'd)

CM3400 Typical DC Characteristics (nominal conditions unless specified otherwise)

Sense Input Current vs. Voltage

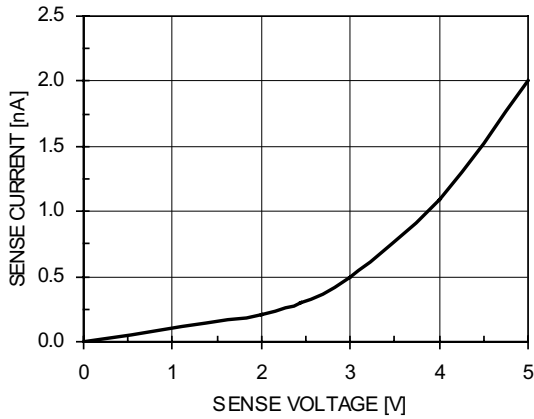

Ground Current vs. Supply

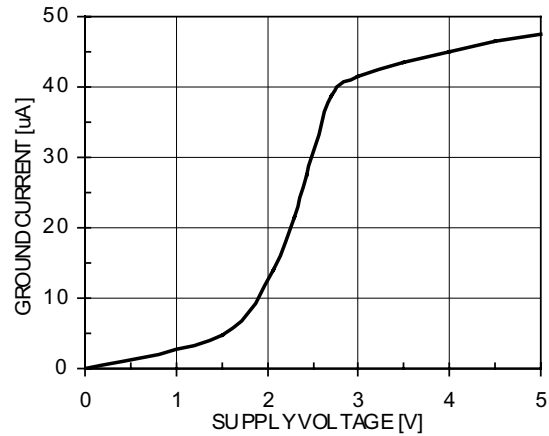

RESET Pull-down Drive Resistance

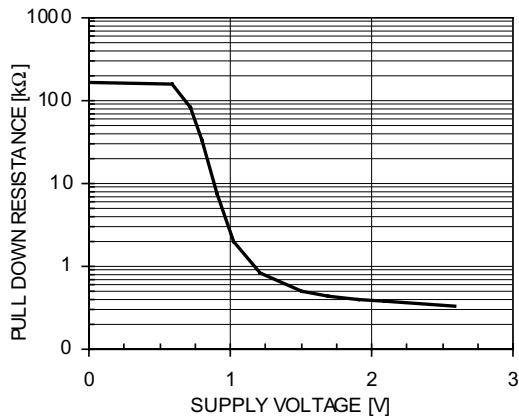

RESET Pull-up Drive Resistance

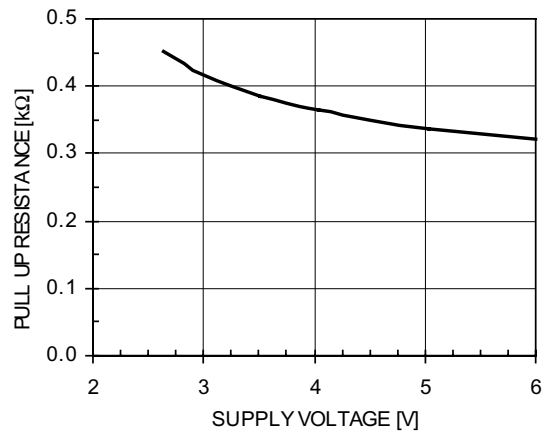

RESET Pull-down Drive Resistance

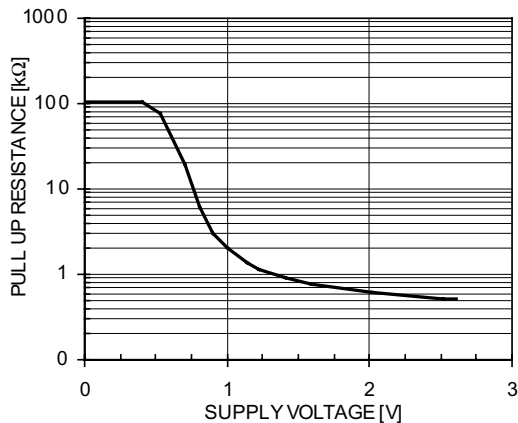

RESET Pull-down Drive Resistance

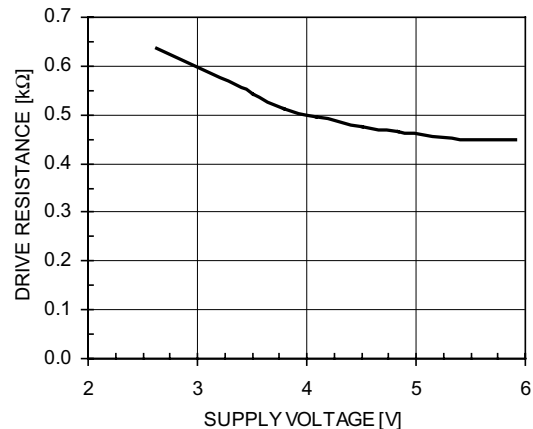



Performance Information (cont'd)

CM3400 Typical Thermal Characteristics (nominal conditions unless specified otherwise)

RESET Propagation Delay vs. Temperature

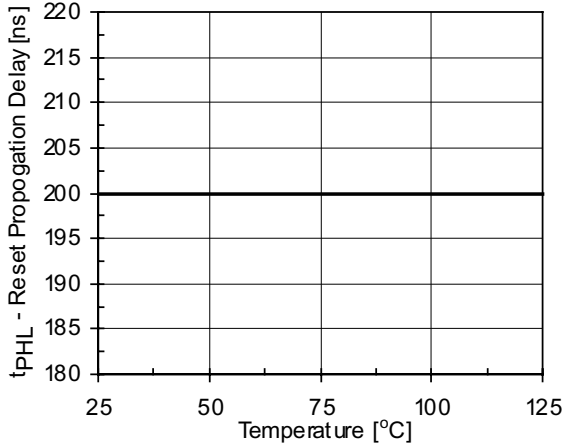

RESET Release Delay (default) vs. Temperature

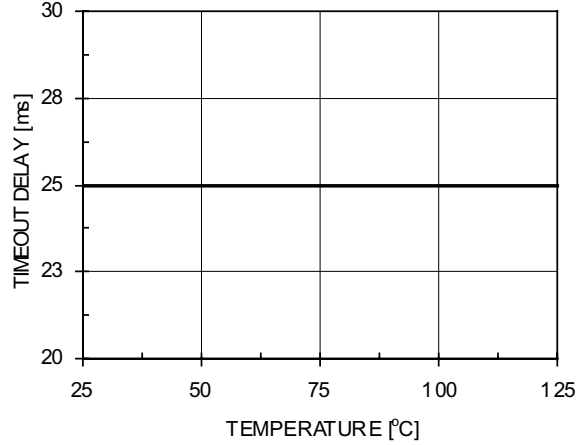

Ground Current vs. Temperature

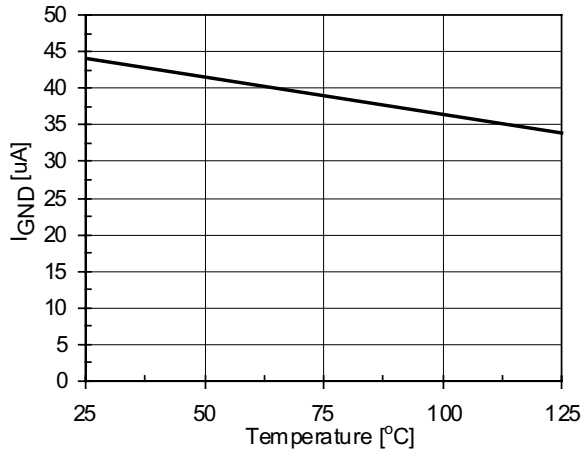

SENSE Threshold vs. Temperature

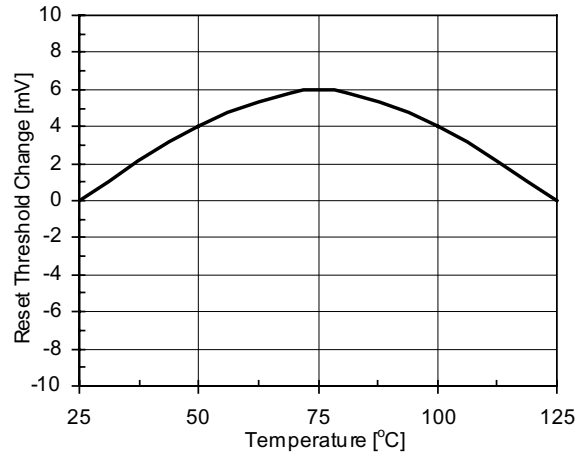

Mechanical Details

The CM3400 is available in an 8-pin SOIC and an 8-pin MSOP package. Dimensions for each of these packages are presented in this section.

SOIC-8 Mechanical Specifications

Dimensions for CM3400-00SN devices packaged in 8-pin SOIC packages are presented below.

For complete information on the SOIC-8 package, see the California Micro Devices SOIC Package Information document.

PACKAGE DIMENSIONS				
Package	SOIC			
Pins	8			
Dimensions	Millimeters		Inches	
	Min	Max	Min	Max
A	1.35	1.75	0.053	0.069
A ₁	0.10	0.25	0.004	0.010
B	0.33	0.51	0.013	0.020
C	0.19	0.25	0.007	0.010
D	4.80	5.00	0.189	0.197
E	3.80	4.19	0.150	0.165
e	1.27 BSC		0.050 BSC	
H	5.80	6.20	0.228	0.244
L	0.40	1.27	0.016	0.050
# per tube	100 pieces*			
# per tape and reel	2500 pieces			
Controlling dimension: inches				

* This is an approximate number which may vary.

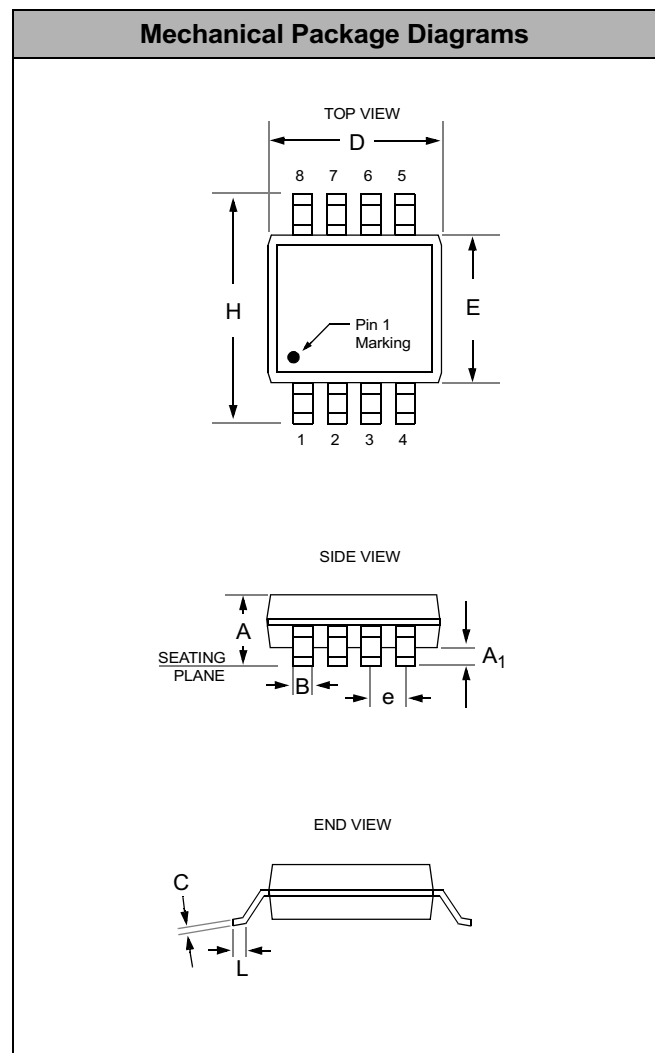

Package Dimensions for SOIC-8



Mechanical Details (cont'd)

MSOP-8 Mechanical Specifications

Dimensions for CM3400-00MS devices packaged in an 8-pin MSOP packages are presented below.

For complete information on the MSOP-8 package, see the California Micro Devices MSOP Package Information document.

PACKAGE DIMENSIONS				
Package	MSOP			
Pins	8			
Dimensions	Millimeters		Inches	
	Min	Max	Min	Max
A	0.87	1.17	0.034	0.046
A1	0.05	0.25	0.002	0.010
B	0.30 (typ)		0.012 (typ)	
C	0.18		0.007	
D	2.90	3.10	0.114	0.122
E	2.90	3.10	0.114	0.122
e	0.65 BSC		0.025 BSC	
H	4.78	4.98	0.188	0.196
L	0.52	0.54	0.017	0.025
# per tube	80 pieces*			
# per tape and reel	4000 pieces			
Controlling dimension: inches				

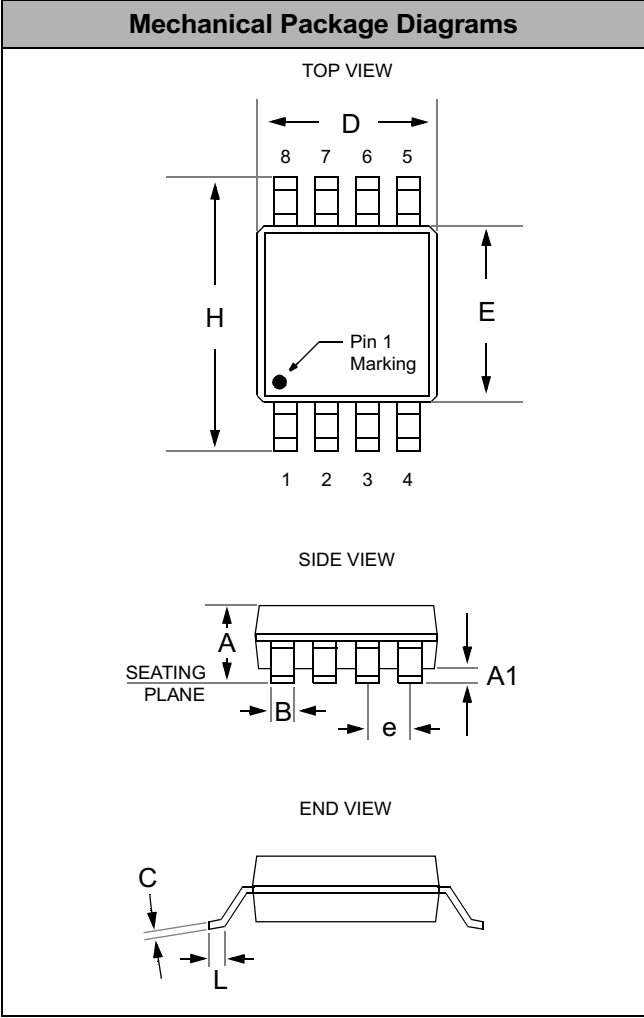

Package Dimensions for MSOP-8

* This is an approximate amount which may vary.