



M/A-COM

ESMD-C50M

E-Series Surface Mount Mixer 80 – 2500 MHz



Features

- LO Power +13 dBm
- Up to +8 dBm RF
- Surface Mount

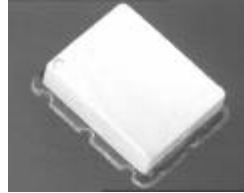

Description

M/A-COM's ESMD-C50M is a Low Cost, Medium Drive, Passive, Double Double Balanced Mixer. Constructed using very broad band ferrite balun transformers and matched silicon schottky diodes. It's performance is especially suited to high dynamic range receivers. Given it's high 1dB compression point, the ESMD-C50M is also suitable for Transmitter upconversion at any frequency up to 2.5GHz.

Schematic

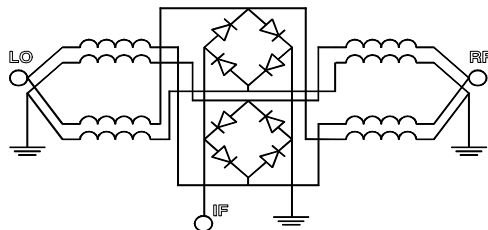

SM-2 Package

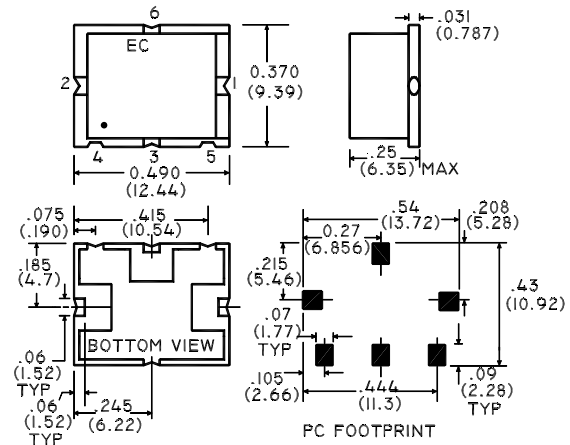

Part Number	Packaging
ESMD-C50M	Tube
ESMD-C50MTR	Tape and Reel

Electrical Specifications @ +25°C

Parameter	Units	Minimum	Typical	Maximum	Mean (x)	Sigma (σ)
Frequency Range	80 - 2500 MHz	—	—	—	—	—
IF 1.0 dB Bandwidth = DC - 1000 MHz	—	—	—	—	—	—
Conversion Loss	80 - 1000 MHz	dB	—	7.5	6.21	0.09
	1000 - 2500 MHz	dB	—	9.0	7.37	0.12
L - R Isolation	80 - 1000 MHz	dB	27.0	32.5	—	—
	1000 - 2500 MHz	dB	22.0	29.1	—	—
L - I Isolation	80 - 1000 MHz	dB	25.0	31.8	—	—
	1000 - 2500 MHz	dB	15.0	19.82	—	—
R - I Isolation	80 - 1000 MHz	dB	22.0	28.3	—	—
	1000 - 2500 MHz	dB	18.0	24.6	—	—
LO VSWR	80 - 1000 MHz	—	—	1.56	2.15	—
	1000 - 2500 MHz	—	—	1.25	1.70	—
RF VSWR	80 - 1000 MHz	—	—	1.62	2.1	—
	1000 - 2500 MHz	—	—	1.71	2.2	—
IF VSWR	DC - 600 MHz	—	—	1.65	2.3	—
Input IP3	200 - 1000 MHz	dBm	21.0	26.6	—	—
	1000 - 2500 MHz	dBm	17.0	23.5	—	—
Input 1dB Compression	dBm	—	+8.0	—	—	—

Test Conditions: LO Drive = +13dBm, IF frequency = 70MHz. Mean and Sigma calculated at 900MHz & 1800MHz.

V2.00 S 1255 D



M/A-COM Division of AMP Incorporated n North America: Tel. (800) 366-2266, Fax (800) 618-8883 n Asia/Pacific: Tel.+85 2 2111 8088, Fax +85 2 2111 8087 n Europe: Tel. +44 (1344) 869 595, Fax+44 (1344) 300 020

www.macom.com

AMP and Connecting at a Higher Level are trademarks. Specifications subject to change without notice.



Absolute Maximum Ratings

Parameter	Absolute Maximum
RF Input Power	+20 dBm
LO Drive Power	+20 dBm
Operating/Storage Temperature	-40°C to +85°C

Pin Configuration

Function	Pin No.
RF	1
LO	2
IF	3
Ground	4,5,6

Typical Performance @ +25°C

Conversion Loss

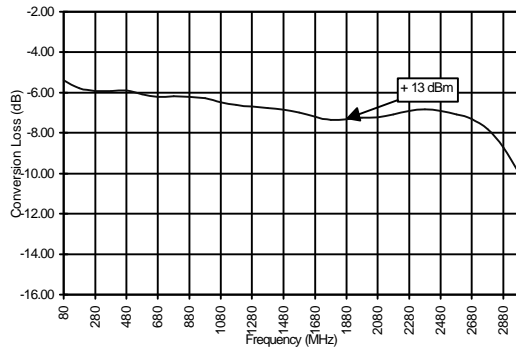

Isolation

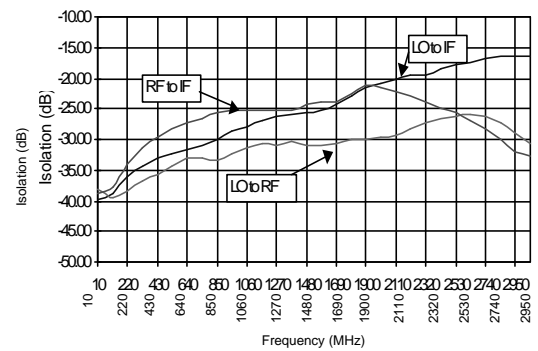

VSWR

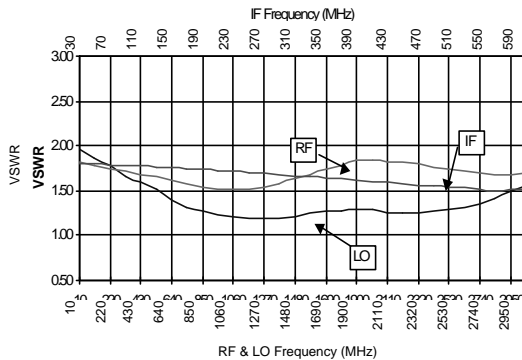

IIP3 & 1dB Compression

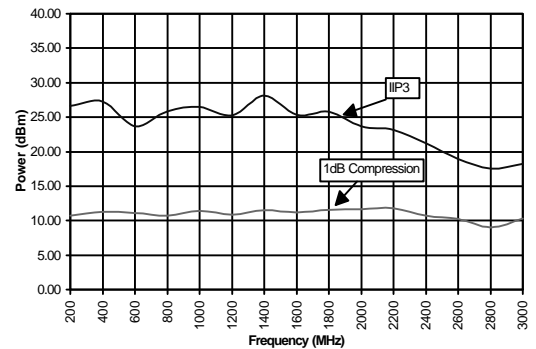

IF Bandwidth

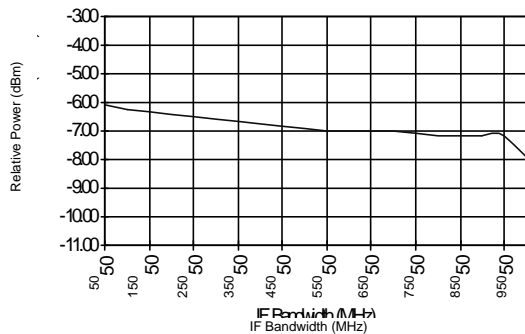

Note: Conversion Loss measured with fixed IF frequency of 70MHz.
All measurements made with input power of +13dBm.

V2.00 S 1255 D



M/A-COM Division of AMP Incorporated n North America: Tel. (800) 366-2266, Fax (800) 618-8883 n Asia/Pacific: Tel.+85 2 2111 8088, Fax +85 2 2111 8087 n Europe: Tel. +44 (1344) 869 595, Fax+44 (1344) 300 020



www.macom.com

AMP and Connecting at a Higher Level are trademarks.
Specifications subject to change without notice.

Spurious Table: 1800MHz

(In dBc below IF, assuming down conversion)

		nf _{LO} - mf _{RF}					
RF	0	X	-3	19	32	28	
	1	19	0	31	17	43	
	2	54	52	52	48	56	
	(n)	3	72	65	78	63	68
		4	83	83	84	82	84
		0	1	2	3	4	

LO (m)

RF = 1842.50 MHz, -5dBm
 LO = 1772.50 MHz, +13dBm
 IF = 70 MHz

Spurious Table: 900MHz

(In dBc below IF, assuming down conversion)

		nf _{LO} - mf _{RF}					
RF	0	X	8	23	15	30	
	1	18	0	36	12	35	
	2	58	49	55	52	53	
	(n)	3	67	68	67	68	67
		4	85	84	82	83	83
		0	1	2	3	4	

LO (m)

RF = 970 MHz, -5dBm
 LO = 900 MHz, +13dBm
 IF = 70 MHz

Spurious Table: 1900MHz

(In dBc below IF, assuming down conversion)

		nf _{LO} - mf _{RF}					
RF	0	X	-5	22	13	29	
	1	16	0	38	17	18	
	2	26	22	23	26	41	
	(n)	3	48	38	50	42	38
		4	50	55	54	52	55
		0	1	2	3	4	

LO (m)

RF = 1960 MHz, -5dBm
 LO = 1890 MHz, +13dBm
 IF = 70 MHz





M/A-COM Division of AMP Incorporated n North America: Tel. (800) 366-2266, Fax (800) 618-8883 n Asia/Pacific: Tel.+85 2 2111 8088,
Fax +85 2 2111 8087 n Europe: Tel. +44 (1344) 869 595, Fax+44 (1344) 300 020

www.macom.com

AMP and Connecting at a Higher Level are trademarks.
Specifications subject to change without notice.

