

## 50 mA, 100 mA, 150 mA CMOS LDOs with Shutdown and Reference Bypass

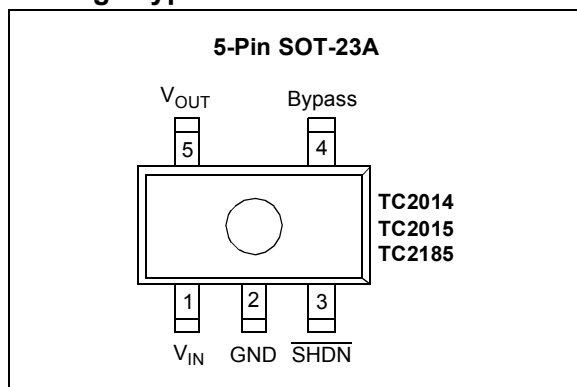
### Features

- Low Supply Current: 80  $\mu$ A (Max)
- Low Dropout Voltage: 140 mV (Typ) @ 150 mA
- High Output Voltage Accuracy:  $\pm 0.4\%$  (Typ)
- Standard or Custom Output Voltages
- Power-Saving Shutdown Mode
- Reference Bypass Input for Ultra Low-Noise Operation
- Fast Shutdown Response Time: 60  $\mu$ sec (Typ)
- Over-Current Protection
- Space-Saving 5-Pin SOT-23A Package
- Pin Compatible Upgrades for Bipolar Regulators
- Wide Operating Temperature Range:  $-40^{\circ}\text{C}$  to  $+125^{\circ}\text{C}$

### Applications

- Battery Operated Systems
- Portable Computers
- Medical Instruments
- Instrumentation
- Cellular / GSM / PHS Phones
- Linear Post-Regulator for SMPS
- Pagers

### Package Type



### General Description

The TC2014, TC2015 and TC2185 are high-accuracy (typically  $\pm 0.4\%$ ) CMOS upgrades for bipolar low dropout regulators, such as the LP2980. Total supply current is typically 55  $\mu$ A; 20 to 60 times lower than in bipolar regulators.

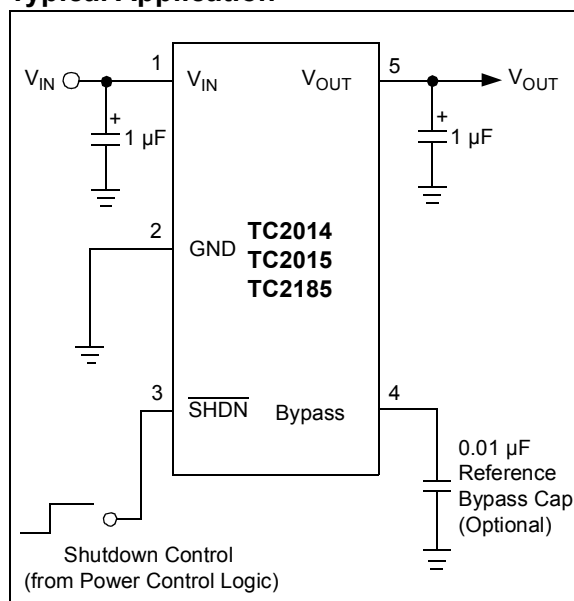
The key features of the device include low noise operation (plus bypass reference), low dropout voltage – typically 45 mV for the TC2014, 90 mV for the TC2015, and 140 mV for the TC2185, at full load – and fast response to step changes in load. Supply current is reduced to 0.5  $\mu$ A (max) and  $V_{OUT}$  falls to zero when the shutdown input is low. The devices also incorporate over-current protection.

The TC2014, TC2015 and TC2185 are stable with an output capacitor of 1  $\mu$ F and have a maximum output current of 50 mA, 100 mA and 150 mA, respectively. For higher output versions, see the TC1107 (DS21356), TC1108 (DS21357) and TC1173 (DS21362) ( $I_{OUT} = 300$  mA) datasheets.

### Related Literature

- Application Notes: AN765, AN766, AN776 and AN792

### Typical Application



## 1.0 ELECTRICAL CHARACTERISTICS

### Absolute Maximum Ratings †

Input Voltage ..... 6.5V  
 Output Voltage .....  $(-0.3)$  to  $(V_{IN} + 0.3)$   
 Operating Temperature .....  $-40^{\circ}\text{C} < T_J < 125^{\circ}\text{C}$   
 Storage Temperature .....  $-65^{\circ}\text{C}$  to  $+150^{\circ}\text{C}$   
 Maximum Voltage on Any Pin .....  $V_{IN} + 0.3\text{V}$  to  $-0.3\text{V}$   
 Maximum Junction Temperature .....  $150^{\circ}\text{C}$

† **Notice:** Stresses above those listed under "Maximum Ratings" may cause permanent damage to the device. This is a stress rating only and functional operation of the device at those or any other conditions above those indicated in the operation listings of this specification is not implied. Exposure to maximum rating conditions for extended periods may affect device reliability.

## PIN FUNCTION TABLE

Name	Function
V <sub>IN</sub>	Unregulated Supply Input
GND	Ground Terminal
SHDN	Shutdown Control Input
Bypass	Reference Bypass Input
V <sub>OUT</sub>	Regulated Voltage Output

## ELECTRICAL CHARACTERISTICS

**Electrical Specifications:** Unless otherwise specified,  $V_{IN} = V_R + 1\text{V}$ ,  $I_L = 100\ \mu\text{A}$ ,  $C_{OUT} = 3.3\ \mu\text{F}$ ,  $\overline{\text{SHDN}} > V_{IH}$ ,  $T_A = +25^{\circ}\text{C}$ .  
**BOLDFACE** type specifications apply for junction temperature of  $-40^{\circ}\text{C}$  to  $+125^{\circ}\text{C}$ .

Parameters	Sym	Min	Typ	Max	Units	Conditions
Input Operating Voltage	V <sub>IN</sub>	<b>2.7</b>	—	<b>6.0</b>	V	<b>Note 1</b>
Maximum Output Current	I <sub>OUTMAX</sub>	<b>50</b>	—	—	mA	TC2014
		<b>100</b>	—	—		TC2015
		<b>150</b>	—	—		TC2185
Output Voltage	V <sub>OUT</sub>	<b>V<sub>R</sub> - 2.0%</b>	V <sub>R</sub> ± 0.4%	<b>V<sub>R</sub> + 2.0%</b>	V	<b>Note 2</b>
V <sub>OUT</sub> Temperature Coefficient	TCV <sub>OUT</sub>	—	20	—	ppm/°C	<b>Note 3</b>
		—	<b>40</b>	—		
Line Regulation	$\Delta V_{OUT}/\Delta V_{IN}$	—	0.05	<b>0.5</b>	%	$(V_R + 1\text{V}) \leq V_{IN} \leq 6\text{V}$
Load Regulation ( <b>Note 4</b> )	$\Delta V_{OUT}/V_{OUT}$	<b>-1.0</b>	0.33	<b>+1.0</b>	%	TC2014; TC2015: I <sub>L</sub> = 0.1 mA to I <sub>OUTMAX</sub>
		<b>-2.0</b>	0.43	<b>+2.0</b>		TC2185: I <sub>L</sub> = 0.1 mA to I <sub>OUTMAX</sub> <b>Note 4</b>
Dropout Voltage	V <sub>IN</sub> - V <sub>OUT</sub>	—	2	—	mV	<b>Note 5</b> I <sub>L</sub> = 100 μA
		—	45	<b>70</b>		I <sub>L</sub> = 50 mA
		—	90	<b>140</b>		TC2015; TC2185 I <sub>L</sub> = 100 mA
		—	140	<b>210</b>		TC2185 I <sub>L</sub> = 150 mA
Supply Current	I <sub>IN</sub>	—	55	<b>80</b>	μA	$\overline{\text{SHDN}} = V_{IH}$ , I <sub>L</sub> = 0
Shutdown Supply Current	I <sub>INSD</sub>	—	0.05	0.5	μA	$\overline{\text{SHDN}} = 0\text{V}$

- Note 1:** The minimum V<sub>IN</sub> has to meet two conditions: V<sub>IN</sub> = 2.7V and V<sub>IN</sub> = V<sub>R</sub> + V<sub>DROPOUT</sub>.  
**Note 2:** V<sub>R</sub> is the regulator output voltage setting. For example: V<sub>R</sub> = 1.8V, 2.7V, 2.8V, 2.85V, 3.0V, 3.3V.  
**Note 3:**

$$TCV_{OUT} = \frac{(V_{OUTMAX} - V_{OUTMIN}) \times 10^{-6}}{V_{OUT} \times \Delta T}$$

- Note 4:** Regulation is measured at a constant junction temperature using low duty cycle pulse testing. Load regulation is tested over a load range from 1.0 mA to the maximum specified output current. Changes in output voltage due to heating effects are covered by the thermal regulation specification.  
**Note 5:** Dropout voltage is defined as the input-to-output differential at which the output voltage drops 2% below its nominal value at a V differential.  
**Note 6:** Thermal Regulation is defined as the change in output voltage at a time T after a change in power dissipation is applied, excluding load or line regulation effects. Specifications are for a current pulse equal to I<sub>MAX</sub> at V<sub>IN</sub> = 6V for T = 10 msec.  
**Note 7:** The maximum allowable power dissipation is a function of ambient temperature, the maximum allowable junction temperature and the thermal resistance from junction-to-air (i.e. T<sub>A</sub>, T<sub>J</sub>, θ<sub>JA</sub>).  
**Note 8:** Time required for V<sub>OUT</sub> to reach 95% of V<sub>R</sub> (output voltage setting), after V<sub>SHDN</sub> is switched from 0 to V<sub>IN</sub>.

## ELECTRICAL CHARACTERISTICS (CONTINUED)

<b>Electrical Specifications:</b> Unless otherwise specified, $V_{IN} = V_R + 1V$ , $I_L = 100 \mu A$ , $C_{OUT} = 3.3 \mu F$ , $\overline{SHDN} > V_{IH}$ , $T_A = +25^\circ C$ . <b>BOLDFACE</b> type specifications apply for junction temperature of $-40^\circ C$ to $+125^\circ C$ .						
Parameters	Sym	Min	Typ	Max	Units	Conditions
Power Supply Rejection Ratio	PSRR	—	55	—	dB	$F \leq 1 \text{ kHz}$ , $C_{bypass} = 0.01 \mu F$
Output Short Circuit Current	$I_{OUTSC}$	—	160	300	mA	$V_{OUT} = 0V$
Thermal Regulation	$\Delta V_{OUT}/\Delta P_D$	—	0.04	—	V/W	<b>Note 6, Note 7</b>
Output Noise	eN	—	200	—	nV/ $\sqrt{Hz}$	$I_L = I_{OUTMAX}$ , $F = 10 \text{ kHz}$ 470 pF from Bypass to GND
Response Time, (Note 8) (from Shutdown Mode)	$T_R$	—	60	—	$\mu\text{sec}$	$V_{IN} = 4V$ , $I_L = 30 \text{ mA}$ , $C_{IN} = 1 \mu F$ , $C_{OUT} = 10 \mu F$
<b>SHDN Input</b>						
SHDN Input High Threshold	$V_{IH}$	<b>60</b>	—	—	% $V_{IN}$	$V_{IN} = 2.5V$ to $6.0V$
SHDN Input Low Threshold	$V_{IL}$	—	—	<b>15</b>	% $V_{IN}$	$V_{IN} = 2.5V$ to $6.0V$

- Note** 1: The minimum  $V_{IN}$  has to meet two conditions:  $V_{IN} = 2.7V$  and  $V_{IN} = V_R + V_{DROPOUT}$ .  
 2:  $V_R$  is the regulator output voltage setting. For example:  $V_R = 1.8V, 2.7V, 2.8V, 2.85V, 3.0V, 3.3V$ .  
 3:

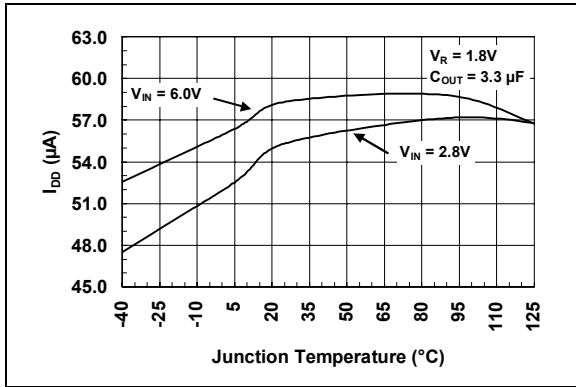
$$TCV_{OUT} = \frac{(V_{OUTMAX} - V_{OUTMIN}) \times 10^{-6}}{V_{OUT} \times \Delta T}$$

- 4: Regulation is measured at a constant junction temperature using low duty cycle pulse testing. Load regulation is tested over a load range from 1.0 mA to the maximum specified output current. Changes in output voltage due to heating effects are covered by the thermal regulation specification.
- 5: Dropout voltage is defined as the input-to-output differential at which the output voltage drops 2% below its nominal value at a V differential.
- 6: Thermal Regulation is defined as the change in output voltage at a time T after a change in power dissipation is applied, excluding load or line regulation effects. Specifications are for a current pulse equal to  $I_{MAX}$  at  $V_{IN} = 6V$  for  $T = 10 \text{ msec}$ .
- 7: The maximum allowable power dissipation is a function of ambient temperature, the maximum allowable junction temperature and the thermal resistance from junction-to-air (i.e.  $T_A, T_J, \theta_{JA}$ ).
- 8: Time required for  $V_{OUT}$  to reach 95% of  $V_R$  (output voltage setting), after  $V_{SHDN}$  is switched from 0 to  $V_{IN}$ .

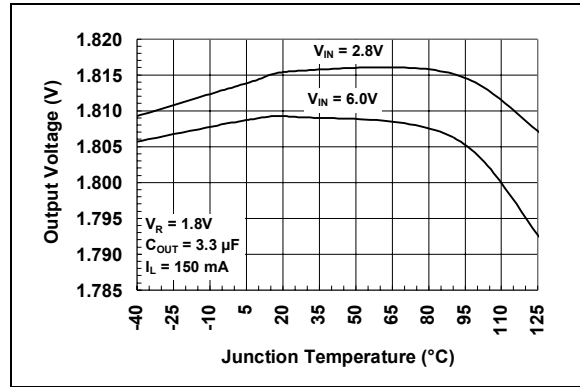
## 2.0 TYPICAL PERFORMANCE CURVES

**Note:** The graphs and tables provided following this note are a statistical summary based on a limited number of samples and are provided for informational purposes only. The performance characteristics listed herein are not tested or guaranteed. In some graphs or tables, the data presented may be outside the specified operating range (e.g., outside specified power supply range) and therefore outside the warranted range.

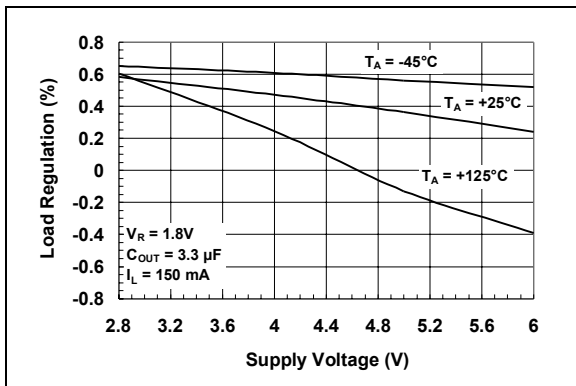
**Note:** Unless otherwise indicated,  $V_{IN} = V_R + 1V$ ,  $I_L = 100 \mu A$ ,  $C_{OUT} = 3.3 \mu F$ ,  $SHDN > V_{IH}$ ,  $T_A = +25^\circ C$ .



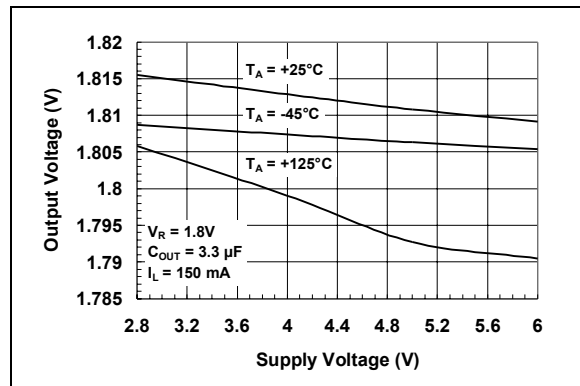
**FIGURE 2-1:** Supply Current vs. Junction Temperature.



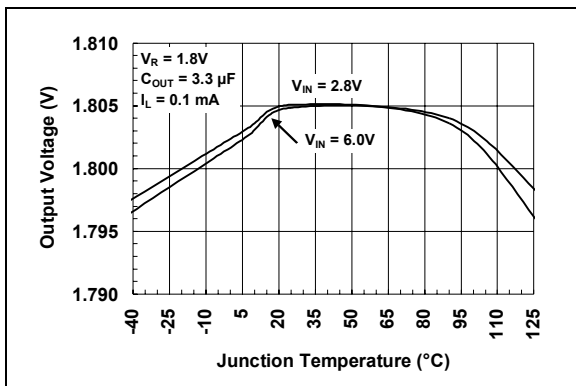
**FIGURE 2-4:** Output Voltage vs. Junction Temperature (150 mA).



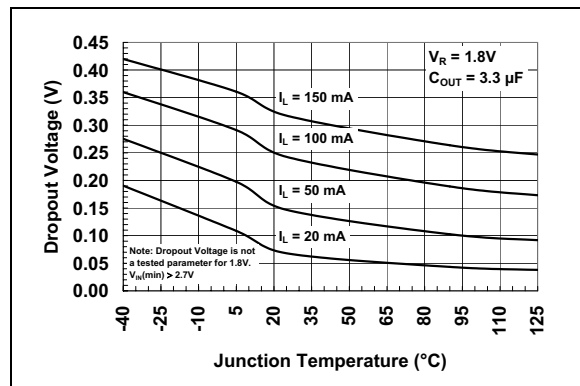
**FIGURE 2-2:** Load Regulation vs. Supply Voltage.



**FIGURE 2-5:** Output Voltage vs. Supply Voltage.

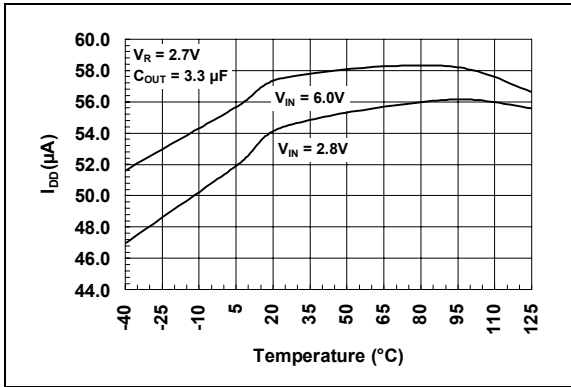


**FIGURE 2-3:** Output Voltage vs. Junction Temperature (0.1 mA).

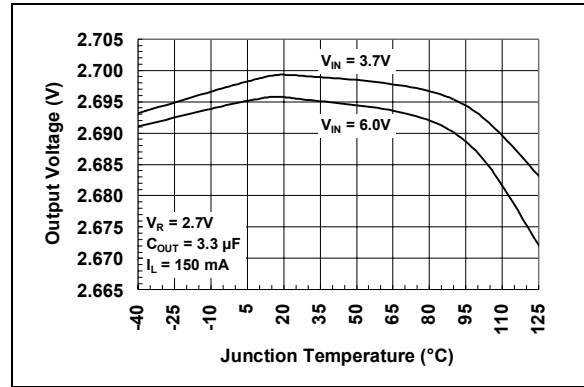


**FIGURE 2-6:** Dropout Voltage vs. Junction Temperature.

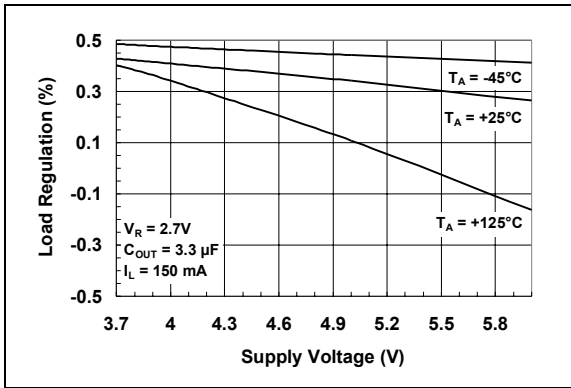
**Note:** Unless otherwise indicated,  $V_{IN} = V_R + 1V$ ,  $I_L = 100 \mu A$ ,  $C_{OUT} = 3.3 \mu F$ ,  $\overline{SHDN} > V_{IH}$ ,  $T_A = +25^\circ C$ .



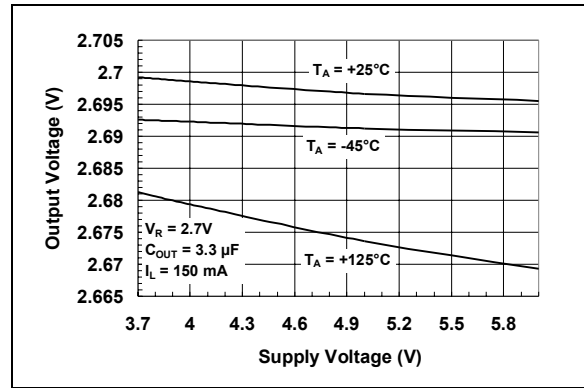
**FIGURE 2-7:** Supply Current vs. Junction Temperature.



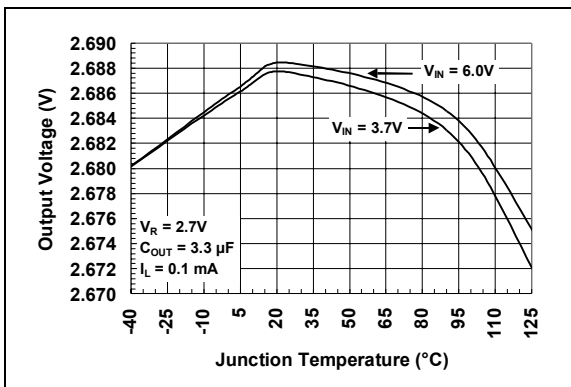
**FIGURE 2-10:** Output Voltage vs. Junction Temperature (150 mA).



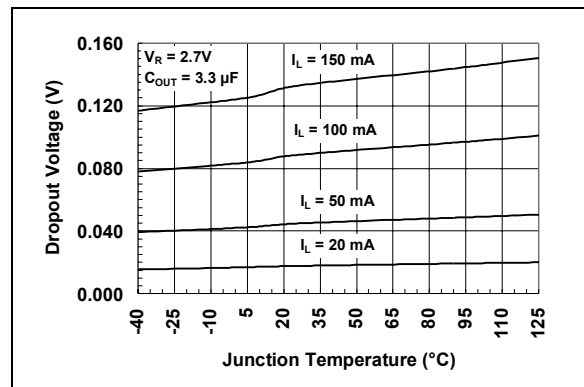
**FIGURE 2-8:** Load Regulation vs. Supply Voltage.



**FIGURE 2-11:** Output Voltage vs. Supply Voltage.



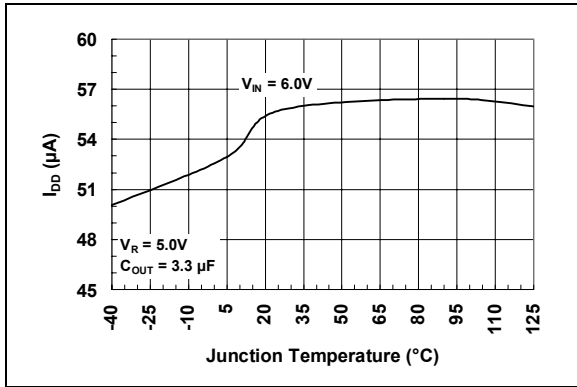
**FIGURE 2-9:** Output Voltage vs. Junction Temperature (0.1 mA).



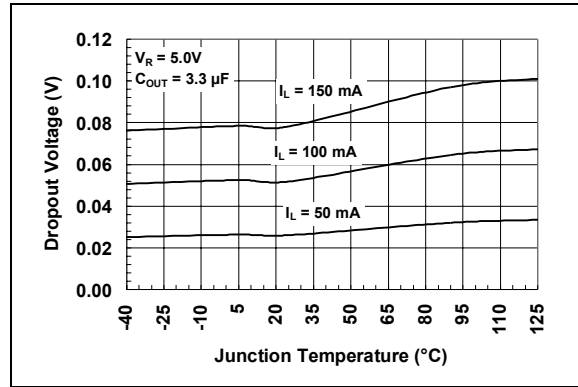
**FIGURE 2-12:** Dropout Voltage vs. Junction Temperature.

# TC2014/2015/2185

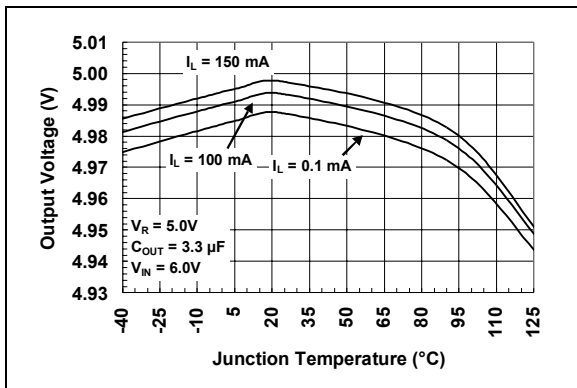
Note: Unless otherwise indicated,  $V_{IN} = V_R + 1V$ ,  $I_L = 100 \mu A$ ,  $C_{OUT} = 3.3 \mu F$ ,  $\overline{SHDN} > V_{IH}$ ,  $T_A = +25^\circ C$ .



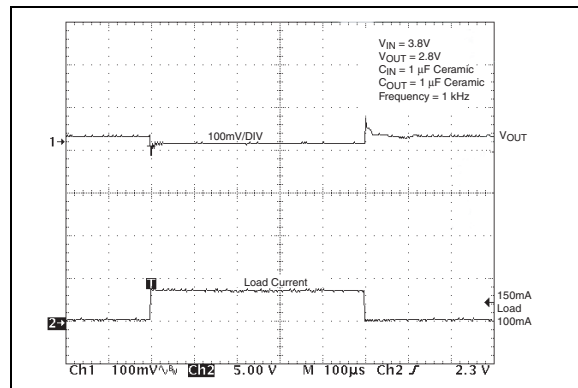
**FIGURE 2-13:** Supply Current vs. Junction Temperature.



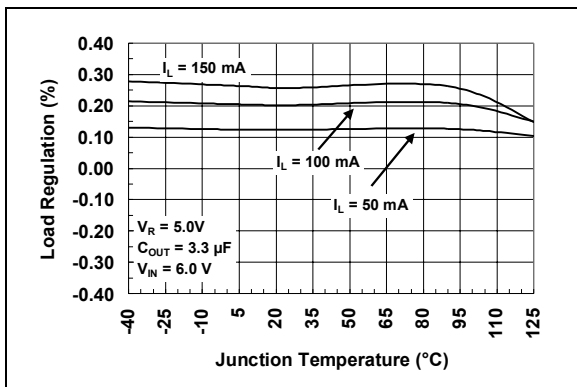
**FIGURE 2-16:** Dropout Voltage vs. Junction Temperature.



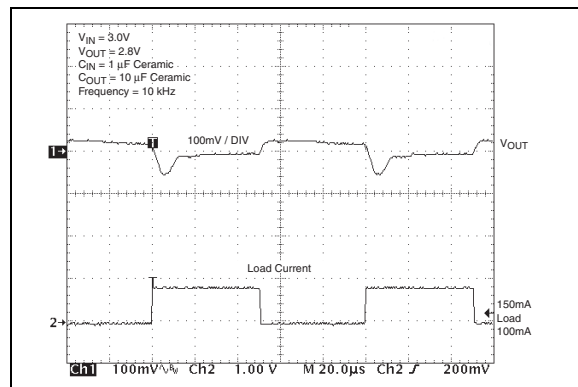
**FIGURE 2-14:** Output Voltage vs. Junction Temperature (150 mA).



**FIGURE 2-17:** Load Transient Response. ( $C_{OUT} = 1 \mu F$ ).

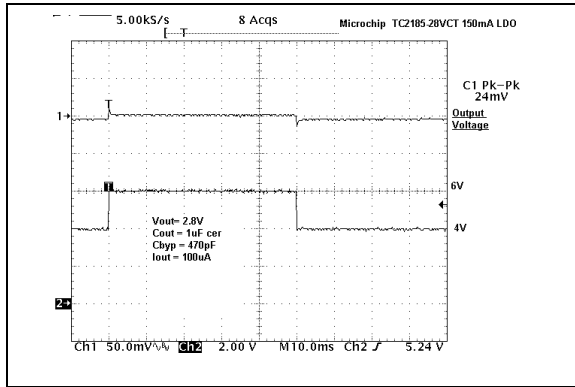


**FIGURE 2-15:** Load Regulation vs. Junction Temperature.

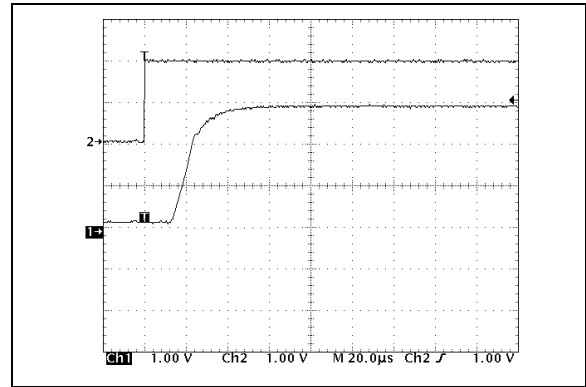


**FIGURE 2-18:** Load Transient Response. ( $C_{OUT} = 10 \mu F$ ).

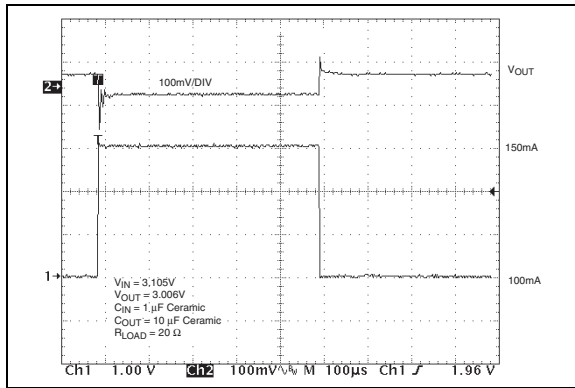
**Note:** Unless otherwise indicated,  $V_{IN} = V_R + 1V$ ,  $I_L = 100 \mu A$ ,  $C_{OUT} = 3.3 \mu F$ ,  $\overline{SHDN} > V_{IH}$ ,  $T_A = +25^\circ C$ .



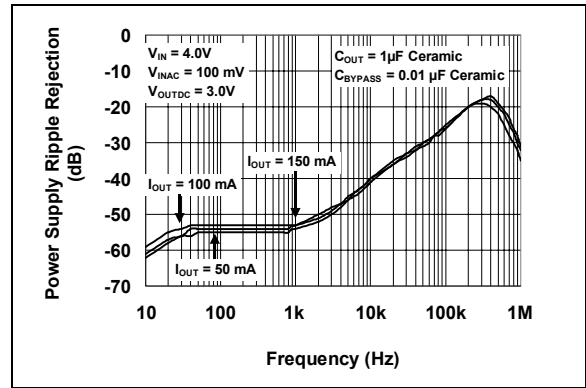
**FIGURE 2-19:** Line Transient Response. ( $C_{OUT} = 1 \mu F$ ).



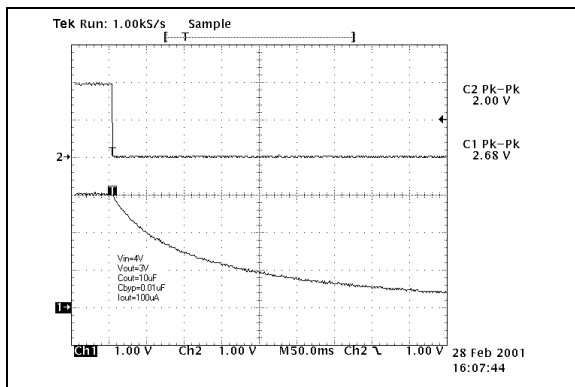
**FIGURE 2-22:** Wake-Up Response.



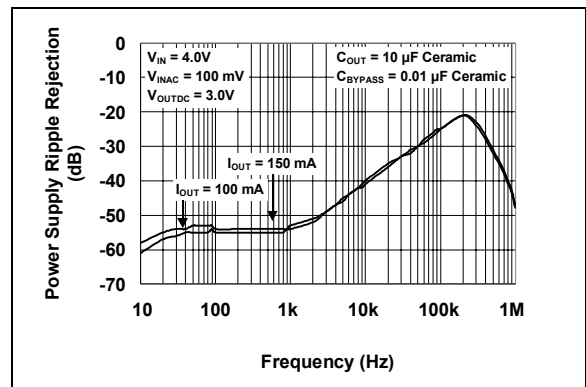
**FIGURE 2-20:** Load Transient Response in Dropout. ( $C_{OUT} = 10 \mu F$ ).



**FIGURE 2-23:** PSRR vs. Frequency ( $C_{OUT} = 1 \mu F$  Ceramic).



**FIGURE 2-21:** Shutdown Delay Time.



**FIGURE 2-24:** PSRR vs. Frequency ( $C_{OUT} = 10 \mu F$  Ceramic).

# TC2014/2015/2185

Note: Unless otherwise indicated,  $V_{IN} = V_R + 1V$ ,  $I_L = 100 \mu A$ ,  $C_{OUT} = 3.3 \mu F$ ,  $\overline{SHDN} > V_{IH}$ ,  $T_A = +25^\circ C$ .

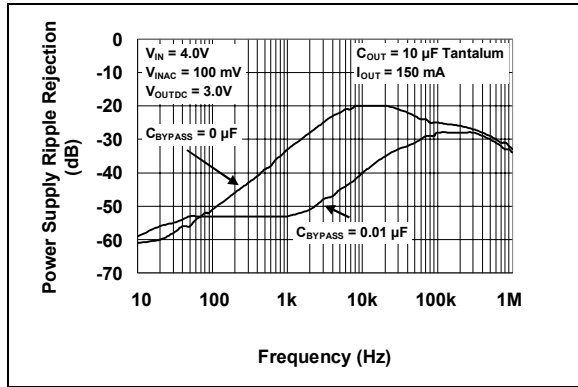


FIGURE 2-25: PSRR vs. Frequency ( $C_{OUT} = 10 \mu F$  Tantalum).

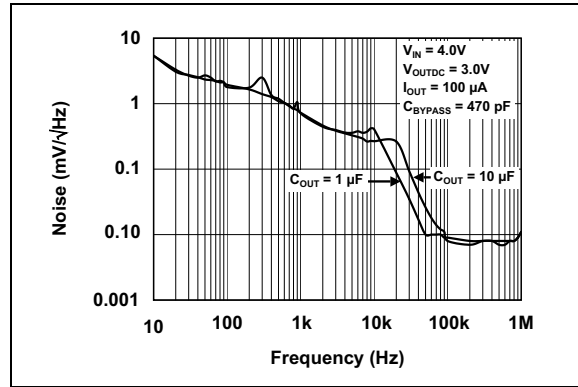


FIGURE 2-26: Output Noise vs. Frequency.



## 3.0 PIN DESCRIPTIONS

The descriptions of the pins are described in Table 3-1.

**TABLE 3-1: PIN FUNCTION TABLE**

Pin No.	Symbol	Description
1	$V_{IN}$	Unregulated supply input
2	GND	Ground terminal
3	$\overline{\text{SHDN}}$	Shutdown control input
4	Bypass	Reference bypass input
5	$V_{OUT}$	Regulated voltage output

### 3.1 Unregulated Supply Input ( $V_{IN}$ )

Connect unregulated input supply to the  $V_{IN}$  pin. If there is a large distance between the input supply and the LDO regulator some input capacitance is necessary for proper operation. A 1  $\mu\text{F}$  capacitor connected from  $V_{IN}$  to ground is recommended for most applications.

### 3.2 Ground Terminal (GND)

Connect the unregulated input supply ground return to GND. Also connect one side of the 1  $\mu\text{F}$  typical input decoupling capacitor close to this pin and one side of the output capacitor  $C_{OUT}$  to this pin.

### 3.3 Shutdown Control Input ( $\overline{\text{SHDN}}$ )

The regulator is fully enabled when a logic high is applied to  $\overline{\text{SHDN}}$ . The regulator enters shutdown when a logic low is applied to this input. During shutdown, output voltage falls to zero and supply current is reduced to 0.5  $\mu\text{A}$  (max).

### 3.4 Reference Bypass Input (Bypass)

Connecting a low value ceramic capacitor to this pin will further reduce output voltage noise and improve the Power Supply Ripple Rejection (PSRR) performance of the LDO. Typical values from 470 pF to 0.01  $\mu\text{F}$  are suggested. Smaller and larger values can be used but do affect the speed at which the LDO output voltage rises when input power is applied. The larger the bypass capacitor, the slower the output voltage will rise.

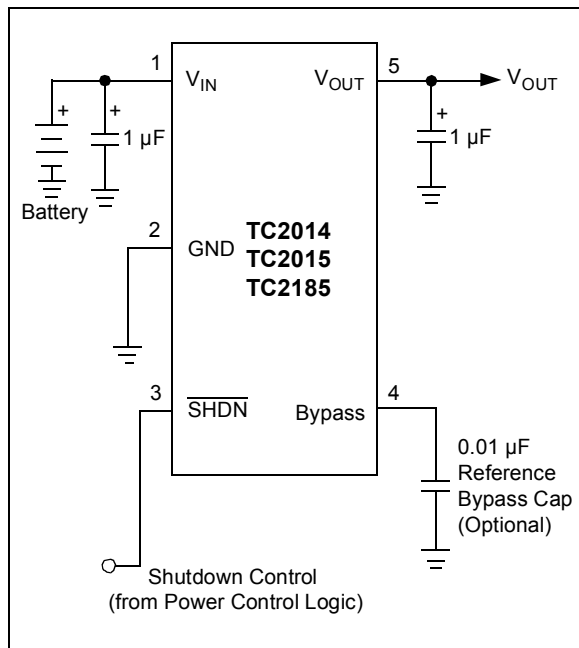
### 3.5 Regulated Voltage Output ( $V_{OUT}$ )

Connect the output load to  $V_{OUT}$  of the LDO. Also connect one side of the LDO output decoupling capacitor as close as possible to the  $V_{OUT}$  pin.

## 4.0 DETAILED DESCRIPTION

The TC2014, TC2015 and TC2185 are precision fixed output voltage regulators (If an adjustable version is needed, see the TC1070, TC1071 or TC1187 (DS21353) datasheet.) Unlike bipolar regulators, the TC2014, TC2015 and TC2185 supply current does not increase with load current. In addition, the LDO output voltage is stable using 1  $\mu\text{F}$  of ceramic or tantalum capacitance over the entire specified input voltage range and output current range.

Figure 4-1 shows a typical application circuit. The regulator is enabled any time the shutdown input (SHDN) is at or above  $V_{IH}$ , and disabled (shutdown) when SHDN is at or below  $V_{IL}$ . SHDN may be controlled by a CMOS logic gate or I/O port of a microcontroller. If the SHDN input is not required, it should be connected directly to the input supply. While in shutdown, supply current decreases to 0.05  $\mu\text{A}$  (typical) and  $V_{OUT}$  falls to zero volts.



**FIGURE 4-1:** Typical Application Circuit.

## 4.1 Bypass Input

A 0.01  $\mu\text{F}$  ceramic capacitor connected from the Bypass input to ground reduces noise present on the internal reference, which in turn significantly reduces output noise. If output noise is not a concern, this input may be left unconnected. Larger capacitor values may be used, but the result is a longer time period to rated output voltage when power is initially applied.

## 4.2 Output Capacitor

A 1  $\mu\text{F}$  (min) capacitor from  $V_{OUT}$  to ground is required. The output capacitor should have an esr (effective series resistance) of 0.01  $\Omega$  to 5  $\Omega$  for  $V_{OUT} \geq 2.5\text{V}$ , and 0.05  $\Omega$  to 5  $\Omega$  for  $V_{OUT} < 2.5\text{V}$ . Ceramic, tantalum or aluminum electrolytic capacitors can be used. When using ceramic capacitors, X5R and X7R dielectric material are recommended due to their stable tolerance over temperature. However, other dielectrics can be used as long as the minimum output capacitance is maintained.

## 4.3 Input Capacitor

A 1  $\mu\text{F}$  capacitor should be connected from  $V_{IN}$  to GND if there is more than 10 inches of wire between the regulator and this AC filter capacitor, or if a battery is used as the power source. Aluminum, electrolytic or tantalum capacitors can be used (Since many aluminum electrolytic capacitors freeze at approximately  $-30^\circ\text{C}$ , solid tantalum are recommended for applications operating below  $-25^\circ\text{C}$ ). When operating from sources other than batteries, supply-noise rejection and transient response can be improved by increasing the value of the input and output capacitors and employing passive filtering techniques.

## 5.0 THERMAL CONSIDERATIONS

### 5.1 Power Dissipation

The amount of power the regulator dissipates is primarily a function of input voltage, output voltage and output current.

The following equation is used to calculate worst-case power dissipation:

#### EQUATION

$$P_D \approx (V_{INMAX} - V_{OUTMIN})I_{LMAX}$$

Where:

$P_D$	=	Worst-case actual power dissipation
$V_{INMAX}$	=	Maximum voltage on $V_{IN}$
$V_{OUTMIN}$	=	Minimum regulator output voltage
$I_{LMAX}$	=	Maximum output (load) current

The maximum allowable power dissipation ( $P_{DMAX}$ ) is a function of the maximum ambient temperature ( $T_{AMAX}$ ), the maximum allowable die temperature ( $T_{JMAX}$ ) (+125°C) and the thermal resistance from junction-to-air ( $\theta_{JA}$ ). The 5-Pin SOT-23A package has a  $\theta_{JA}$  of approximately 220°C/Watt when mounted on a typical two layer FR4 dielectric copper clad PC board.

#### EQUATION

$$P_{DMAX} = \frac{T_{JMAX} - T_{AMAX}}{\theta_{JA}}$$

Where all terms are previously defined.

The  $P_D$  equation can be used in conjunction with the  $P_{DMAX}$  equation to ensure regulator thermal operation is within limits. For example:

Given:

$V_{INMAX}$	=	3.0V +10%
$V_{OUTMIN}$	=	2.7V - 2.5%
$I_{LOADMAX}$	=	40 mA
$T_{JMAX}$	=	+125°C
$T_{AMAX}$	=	+55°C

Find:

1. Actual power dissipation
2. Maximum allowable dissipation

Actual power dissipation:

$$\begin{aligned} P_D &= (V_{INMAX} - V_{OUTMIN})I_{LMAX} \\ &= \frac{[(3.0 \times 1.1) - (2.7 \times 0.975)]40 \times 10^{-3}}{220} \\ &= 26.7mW \end{aligned}$$

Maximum allowable power dissipation:

$$\begin{aligned} P_{DMAX} &= \frac{T_{JMAX} - T_{AMAX}}{\theta_{JA}} \\ &= \frac{125 - 55}{220} \\ &= 318mW \end{aligned}$$

In this example, the TC2014 dissipates a maximum of only 26.7 mW; far below the allowable limit of 318 mW. In a similar manner, the  $P_D$  equation and  $P_{DMAX}$  equation can be used to calculate maximum current and/or input voltage limits.

### 5.2 Layout Considerations

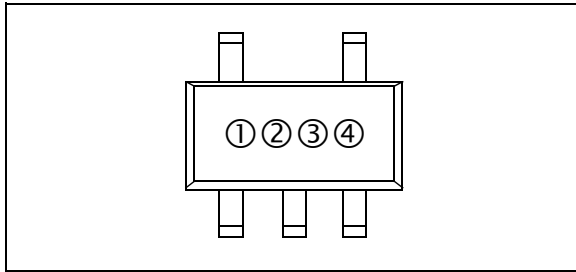
The primary path of heat conduction out of the package is via the package leads. Therefore, layouts having a ground plane, wide traces at the pads and wide power supply bus lines combine to lower  $\theta_{JA}$  and, therefore, increase the maximum allowable power dissipation limit.

# TC2014/2015/2185

---

## 6.0 PACKAGING INFORMATION

### 6.1 Package Marking Information



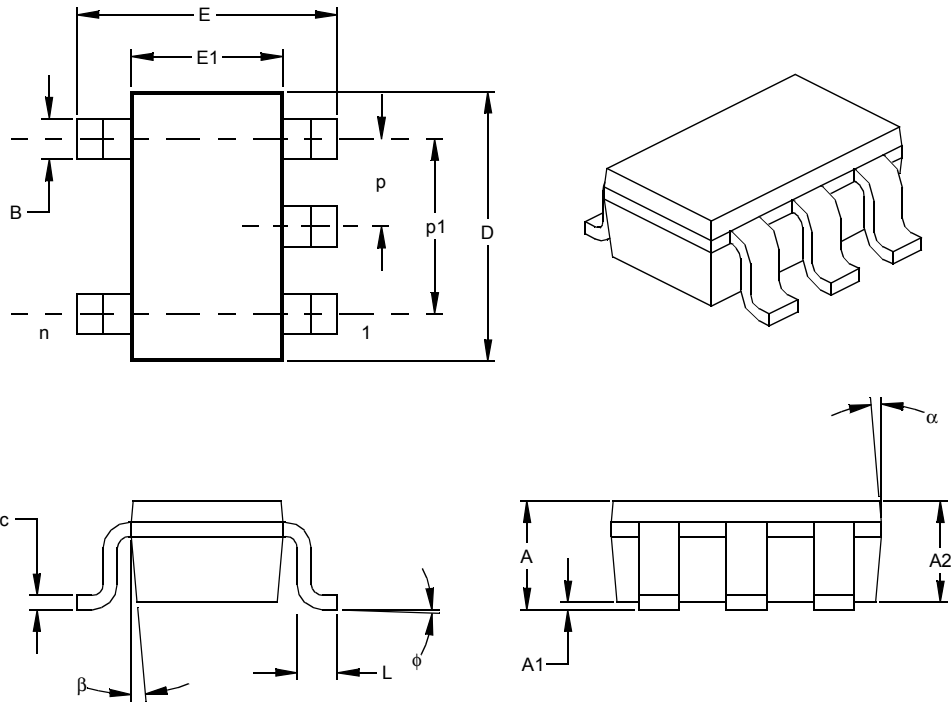
① & ② represents part number code + temperature range and voltage

(V)	TC2014	TC2015	TC2185
1.8	PA	RA	UA
2.5	PB	RB	UB
2.7	PC	RC	UC
2.8	PD	RD	UD
2.85	PE	RE	UE
3.0	PF	RF	UF
3.3	PG	RG	UG

③ represents year and 2-month period code

④ represents lot ID number

## 5-Lead Plastic Small Outline Transistor (OT) (SOT23)



Units		INCHES*			MILLIMETERS		
Dimension	Limits	MIN	NOM	MAX	MIN	NOM	MAX
Number of Pins	n		5			5	
Pitch	p		.038			0.95	
Outside lead pitch (basic)	p1		.075			1.90	
Overall Height	A	.035	.046	.057	0.90	1.18	1.45
Molded Package Thickness	A2	.035	.043	.051	0.90	1.10	1.30
Standoff §	A1	.000	.003	.006	0.00	0.08	0.15
Overall Width	E	.102	.110	.118	2.60	2.80	3.00
Molded Package Width	E1	.059	.064	.069	1.50	1.63	1.75
Overall Length	D	.110	.116	.122	2.80	2.95	3.10
Foot Length	L	.014	.018	.022	0.35	0.45	0.55
Foot Angle	φ	0	5	10	0	5	10
Lead Thickness	c	.004	.006	.008	0.09	0.15	0.20
Lead Width	B	.014	.017	.020	0.35	0.43	0.50
Mold Draft Angle Top	α	0	5	10	0	5	10
Mold Draft Angle Bottom	β	0	5	10	0	5	10

\* Controlling Parameter  
 § Significant Characteristic

Notes:

Dimensions D and E1 do not include mold flash or protrusions. Mold flash or protrusions shall not exceed .010" (0.254mm) per side.

JEDEC Equivalent: MO-178

Drawing No. C04-091

NOTES:

## PRODUCT IDENTIFICATION SYSTEM

To order or obtain information, e.g., on pricing or delivery, refer to the factory or the listed sales office.

<u>PART NO.</u>	<u>-XX</u>	<u>X</u>	<u>XXXX</u>	<b>Examples:</b>
Device	Output Voltage	Temperature Range	Package	
Device:	TC2014: 50 mA LDO with Shutdown and VREF Bypass TC2015: 100 mA LDO with Shutdown and VREF Bypass TC2185: 150 mA LDO with Shutdown and VREF Bypass			a) TC2014-1.8VCTTR: 5LD SOT-23-A, 1.8V, Tape and Reel. b) TC2014-2.85VCTTR: 5LD SOT-23-A, 2.85V, Tape and Reel. c) TC2014-3.3VCTTR: 5LD SOT-23-A, 3.3V, Tape and Reel.
Output Voltage:	XX = 1.8V XX = 2.7V XX = 2.8V XX = 3.0V XX = 3.3V			a) TC2015-1.8VCTTR: 5LD SOT-23-A, 1.8V, Tape and Reel. b) TC2015-2.85VCTTR: 5LD SOT-23-A, 2.85V, Tape and Reel. c) TC2015-3.0VCTTR: 5LD SOT-23-A, 3.0V, Tape and Reel.
Temperature Range:	V = -40°C to +125°C			a) TC2185-1.8VCTTR: 5LD SOT-23-A, 1.8V, Tape and Reel. b) TC2185-2.8VCTTR: 5LD SOT-23-A, 2.8V, Tape and Reel.
Package:	CTTR = Plastic Small Outline Transistor (SOT-23), 5-lead, Tape and Reel			

## Sales and Support

### Data Sheets

Products supported by a preliminary Data Sheet may have an errata sheet describing minor operational differences and recommended workarounds. To determine if an errata sheet exists for a particular device, please contact one of the following:

1. Your local Microchip sales office
2. The Microchip Corporate Literature Center U.S. FAX: (480) 792-7277
3. The Microchip Worldwide Site ([www.microchip.com](http://www.microchip.com))

Please specify which device, revision of silicon and Data Sheet (include Literature #) you are using.

### Customer Notification System

Register on our web site ([www.microchip.com/cn](http://www.microchip.com/cn)) to receive the most current information on our products.

NOTES:



---

**Note the following details of the code protection feature on Microchip devices:**

- Microchip products meet the specification contained in their particular Microchip Data Sheet.
- Microchip believes that its family of products is one of the most secure families of its kind on the market today, when used in the intended manner and under normal conditions.
- There are dishonest and possibly illegal methods used to breach the code protection feature. All of these methods, to our knowledge, require using the Microchip products in a manner outside the operating specifications contained in Microchip's Data Sheets. Most likely, the person doing so is engaged in theft of intellectual property.
- Microchip is willing to work with the customer who is concerned about the integrity of their code.
- Neither Microchip nor any other semiconductor manufacturer can guarantee the security of their code. Code protection does not mean that we are guaranteeing the product as "unbreakable."

Code protection is constantly evolving. We at Microchip are committed to continuously improving the code protection features of our products. Attempts to break microchip's code protection feature may be a violation of the Digital Millennium Copyright Act. If such acts allow unauthorized access to your software or other copyrighted work, you may have a right to sue for relief under that Act.

---

Information contained in this publication regarding device applications and the like is intended through suggestion only and may be superseded by updates. It is your responsibility to ensure that your application meets with your specifications. No representation or warranty is given and no liability is assumed by Microchip Technology Incorporated with respect to the accuracy or use of such information, or infringement of patents or other intellectual property rights arising from such use or otherwise. Use of Microchip's products as critical components in life support systems is not authorized except with express written approval by Microchip. No licenses are conveyed, implicitly or otherwise, under any intellectual property rights.

**Trademarks**

The Microchip name and logo, the Microchip logo, KEELOQ, MPLAB, PIC, PICmicro, PICSTART, PRO MATE and PowerSmart are registered trademarks of Microchip Technology Incorporated in the U.S.A. and other countries.


FilterLab, microID, MXDEV, MXLAB, PICMASTER, SEEVAL and The Embedded Control Solutions Company are registered trademarks of Microchip Technology Incorporated in the U.S.A.

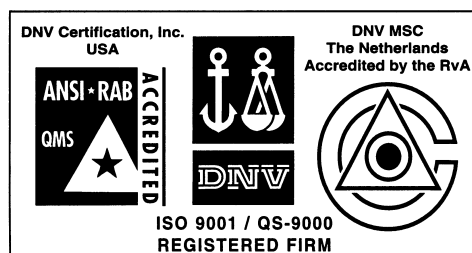
Accuron, dsPIC, dsPICDEM.net, ECONOMONITOR, FanSense, FlexROM, fuzzyLAB, In-Circuit Serial Programming, ICSP, ICEPIC, microPort, Migratable Memory, MPASM, MPLIB, MPLINK, MPSIM, PICC, PICKit, PICDEM, PICDEM.net, PowerCal, PowerInfo, PowerTool, rPIC, Select Mode, SmartSensor, SmartShunt, SmartTel and Total Endurance are trademarks of Microchip Technology Incorporated in the U.S.A. and other countries.

Serialized Quick Turn Programming (SQTP) is a service mark of Microchip Technology Incorporated in the U.S.A.

All other trademarks mentioned herein are property of their respective companies.

© 2003, Microchip Technology Incorporated, Printed in the U.S.A., All Rights Reserved.

 Printed on recycled paper.



*Microchip received QS-9000 quality system certification for its worldwide headquarters, design and wafer fabrication facilities in Chandler and Tempe, Arizona in July 1999 and Mountain View, California in March 2002. The Company's quality system processes and procedures are QS-9000 compliant for its PICmicro® 8-bit MCUs, KEELOQ® code hopping devices, Serial EEPROMs, microperipherals, non-volatile memory and analog products. In addition, Microchip's quality system for the design and manufacture of development systems is ISO 9001 certified.*



# MICROCHIP

## WORLDWIDE SALES AND SERVICE

### AMERICAS

#### Corporate Office

2355 West Chandler Blvd.  
Chandler, AZ 85224-6199  
Tel: 480-792-7200 Fax: 480-792-7277  
Technical Support: 480-792-7627  
Web Address: <http://www.microchip.com>

#### Rocky Mountain

2355 West Chandler Blvd.  
Chandler, AZ 85224-6199  
Tel: 480-792-7966 Fax: 480-792-4338

#### Atlanta

3780 Mansell Road, Suite 130  
Alpharetta, GA 30022  
Tel: 770-640-0034 Fax: 770-640-0307

#### Boston

2 Lan Drive, Suite 120  
Westford, MA 01886  
Tel: 978-692-3848 Fax: 978-692-3821

#### Chicago

333 Pierce Road, Suite 180  
Itasca, IL 60143  
Tel: 630-285-0071 Fax: 630-285-0075

#### Dallas

4570 Westgrove Drive, Suite 160  
Addison, TX 75001  
Tel: 972-818-7423 Fax: 972-818-2924

#### Detroit

Tri-Atria Office Building  
32255 Northwestern Highway, Suite 190  
Farmington Hills, MI 48334  
Tel: 248-538-2250 Fax: 248-538-2260

#### Kokomo

2767 S. Albright Road  
Kokomo, Indiana 46902  
Tel: 765-864-8360 Fax: 765-864-8387

#### Los Angeles

18201 Von Karman, Suite 1090  
Irvine, CA 92612  
Tel: 949-263-1888 Fax: 949-263-1338

#### San Jose

Microchip Technology Inc.  
2107 North First Street, Suite 590  
San Jose, CA 95131  
Tel: 408-436-7950 Fax: 408-436-7955

#### Toronto

6285 Northam Drive, Suite 108  
Mississauga, Ontario L4V 1X5, Canada  
Tel: 905-673-0699 Fax: 905-673-6509

### ASIA/PACIFIC

#### Australia

Microchip Technology Australia Pty Ltd  
Suite 22, 41 Rawson Street  
Epping 2121, NSW  
Australia  
Tel: 61-2-9868-6733 Fax: 61-2-9868-6755

#### China - Beijing

Microchip Technology Consulting (Shanghai)  
Co., Ltd., Beijing Liaison Office  
Unit 915  
Bei Hai Wan Tai Bldg.  
No. 6 Chaoyangmen Beidajie  
Beijing, 100027, No. China  
Tel: 86-10-85282100 Fax: 86-10-85282104

#### China - Chengdu

Microchip Technology Consulting (Shanghai)  
Co., Ltd., Chengdu Liaison Office  
Rm. 2401-2402, 24th Floor,  
Ming Xing Financial Tower  
No. 88 TIDU Street  
Chengdu 610016, China  
Tel: 86-28-86766200 Fax: 86-28-86766599

#### China - Fuzhou

Microchip Technology Consulting (Shanghai)  
Co., Ltd., Fuzhou Liaison Office  
Unit 28F, World Trade Plaza  
No. 71 Wusi Road  
Fuzhou 350001, China  
Tel: 86-591-7503506 Fax: 86-591-7503521

#### China - Hong Kong SAR

Microchip Technology Hongkong Ltd.  
Unit 901-6, Tower 2, Metroplaza  
223 Hing Fong Road  
Kwai Fong, N.T., Hong Kong  
Tel: 852-2401-1200 Fax: 852-2401-3431

#### China - Shanghai

Microchip Technology Consulting (Shanghai)  
Co., Ltd.  
Room 701, Bldg. B  
Far East International Plaza  
No. 317 Xian Xia Road  
Shanghai, 200051  
Tel: 86-21-6275-5700 Fax: 86-21-6275-5060

#### China - Shenzhen

Microchip Technology Consulting (Shanghai)  
Co., Ltd., Shenzhen Liaison Office  
Rm. 1812, 18/F, Building A, United Plaza  
No. 5022 Binhe Road, Futian District  
Shenzhen 518033, China  
Tel: 86-755-82901380 Fax: 86-755-82966626

#### China - Qingdao

Rm. B503, Fullhope Plaza,  
No. 12 Hong Kong Central Rd.  
Qingdao 266071, China  
Tel: 86-532-5027355 Fax: 86-532-5027205

#### India

Microchip Technology Inc.  
India Liaison Office  
Divyasree Chambers  
1 Floor, Wing A (A3/A4)  
No. 11, O'Shaughnessey Road  
Bangalore, 560 025, India  
Tel: 91-80-2290061 Fax: 91-80-2290062

### Japan

Microchip Technology Japan K.K.  
Benex S-1 6F  
3-18-20, Shinyokohama  
Kohoku-Ku, Yokohama-shi  
Kanagawa, 222-0033, Japan  
Tel: 81-45-471-6166 Fax: 81-45-471-6122

### Korea

Microchip Technology Korea  
168-1, Youngbo Bldg. 3 Floor  
Samsung-Dong, Kangnam-Ku  
Seoul, Korea 135-882  
Tel: 82-2-554-7200 Fax: 82-2-558-5934

### Singapore

Microchip Technology Singapore Pte Ltd.  
200 Middle Road  
#07-02 Prime Centre  
Singapore, 188980  
Tel: 65-6334-8870 Fax: 65-6334-8850

### Taiwan

Microchip Technology (Barbados) Inc.,  
Taiwan Branch  
11F-3, No. 207  
Tung Hua North Road  
Taipei, 105, Taiwan  
Tel: 886-2-2717-7175 Fax: 886-2-2545-0139

### EUROPE

#### Austria

Microchip Technology Austria GmbH  
Durisolstrasse 2  
A-4600 Wels  
Austria  
Tel: 43-7242-2244-399  
Fax: 43-7242-2244-393

#### Denmark

Microchip Technology Nordic ApS  
Regus Business Centre  
Lautrup høj 1-3  
Ballerup DK-2750 Denmark  
Tel: 45 4420 9895 Fax: 45 4420 9910

#### France

Microchip Technology SARL  
Parc d'Activite du Moulin de Massy  
43 Rue du Saule Trapu  
Batiment A - 1er Etage  
91300 Massy, France  
Tel: 33-1-69-53-63-20 Fax: 33-1-69-30-90-79

#### Germany

Microchip Technology GmbH  
Steinheilstrasse 10  
D-85737 Ismaning, Germany  
Tel: 49-89-627-144 0 Fax: 49-89-627-144-44

#### Italy

Microchip Technology SRL  
Centro Direzionale Colleoni  
Palazzo Taurus 1 V. Le Colleoni 1  
20041 Agrate Brianza  
Milan, Italy  
Tel: 39-039-65791-1 Fax: 39-039-6899883

#### United Kingdom

Microchip Ltd.  
505 Eskdale Road  
Winkersley Triangle  
Wokingham  
Berkshire, England RG41 5TU  
Tel: 44 118 921 5869 Fax: 44-118 921-5820

12/05/02