



PRODUCT SPECIFICATION

Model No : CSD-822A9/823A9

Descriptions:

- 0.8 Inch Dual Digits Display
- CSD-822: Common Anode
- CSD-823: Common Cathode
- Emitting Color: Super Bright Amber



CUSTOMER APPROVED SIGNATURES	APPROVED BY	CHECKED BY	PREPARED BY

CHINA SEMICONDUCTOR CORPORATION

Address:2FL. NO.909,Chung-Cheng Road,
Chung-Ho City Taipei Hsien,Taiwan.

Tel:886-2-2223-9696
Fax:886-2-2223-9377

OPTO PLUS TECHNOLOGIES CO.,LTD

Address:696 Shun jiang Rd.,Ji Shan St.Shaoxing,
ZheJiang,China

Tel:86-0575-8623888
Fax:86-0575-8623112



Model No : CSD-822/823A9

Features -

1. 0.8 inch (20.3mm) digit height.
2. Case mold type.
3. RoHs compliant.
4. Low power consumption.
5. Easy mounting on P.C. board or socket.

Device Selection Guide -

Part No.	Chip		Description
	Material	Emitted Color	
CSD-822A9	AlGaInP	Super Bright Amber	Common Anode
CSD-823A9	AlGaInP	Super Bright Amber	Common Cathode

Package Dimensions -

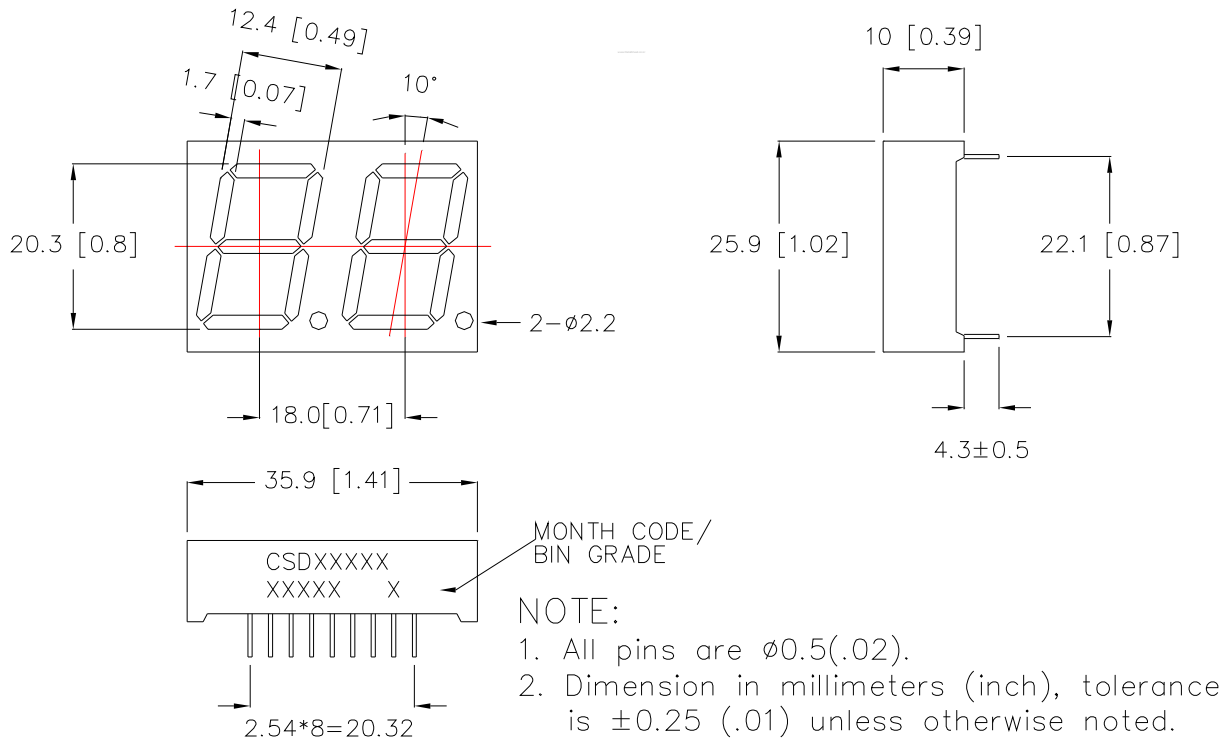



Model No : CSD-822/823A9

Internal Circuit Diagrams -

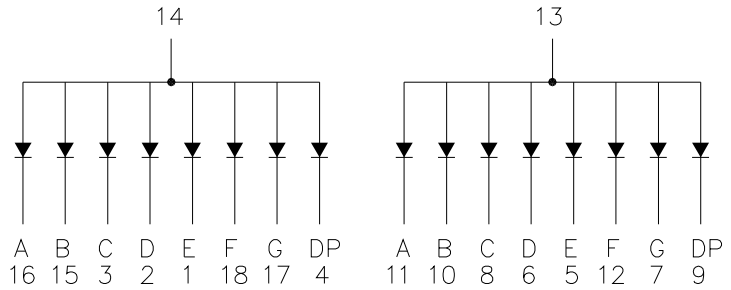
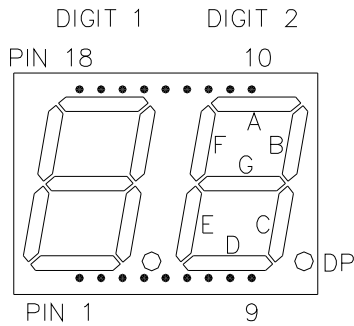

CSS-822 Common Anode.
(CSS-823 is Common Cathode.)

Absolute Maximum Rating -

(Ta=25°C)

Parameter	Symbol	Rating	Unit
Power Dissipation Per Dice	Pd	70	mW
Continuous Forward Current Per Dice	IAF	25	mA
Peak Current Per Dice(Duty cycle 1/10,1KHz)	IPF	90	mA
Derating Linear From 25°C Per Dice	-	0.33	mA/°C
Reverse Voltage Per Dice	VR	5	V
Operating Temp.	Topr	-35 ~ +85	°C
Storage Temp.	Tstg	-35 ~ +85	°C
Solder temperature 1/16 inch below seating plane for 3 seconds at 260°C			



Model No : CSD-822/823A9

■ Electro-optical Characteristics -

(Ta=25°C)

Parameter	Symbol	Min.	Typ.	Max.	Unit	Condition
Forward Voltage Per Segment	V _F	-	2.0	2.8	V	I _F =20mA
Luminous Intensity Per Segment	I _v	-	25	-	mcd	I _F =10mA
Peak Emission Wavelength	λ _p	-	610	-	nm	I _F =20mA
Dominant Wavelength	λ _d	-	605	-	nm	I _F =20mA
Spectrum Radiation Bandwidth	Δλ	-	20	-	nm	I _F =20mA
Reverse Current	I _R	-	-	100	μA	V _R =5V
Luminous Intensity Matching Ratio	IV-m	-	-	2:1	-	I _F =10mA



Model No : CSD-822/823A9

Typical Electrical / Optical Charateristics Curves -

(Ta = 25°C Unless Otherwise Noted)

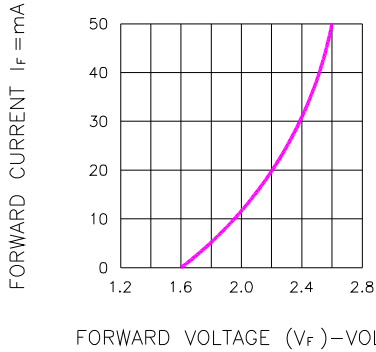

Fig.1 FORWARD CURRENT VS. FORWARD VOLTAGE

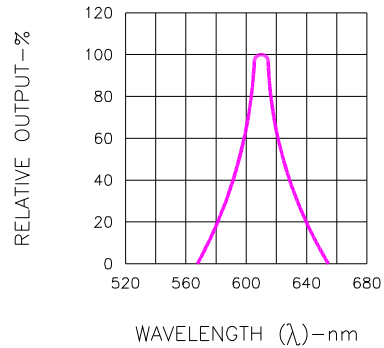

Fig.2 SPECTRAL RESPONSE

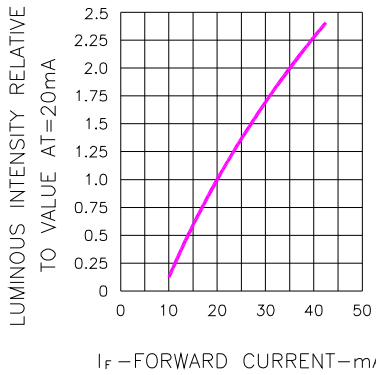

Fig.3 RELATIVE LUMINOUS INTENSITY VS. FORWARD CURRENT

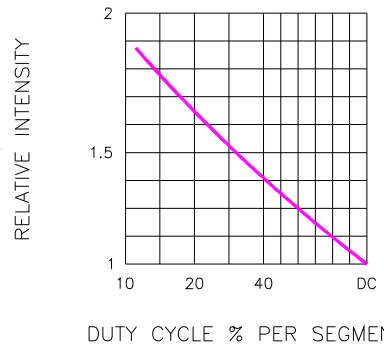

Fig.5 LUMINOUS INTENSITY VS. DUTY CYCLE

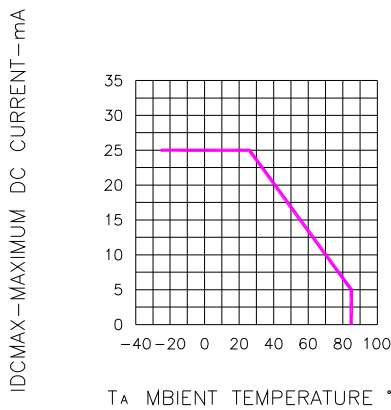

Fig.4 MAXIMUM ALLOWABLE DC CURRENT PER SEGMENT VS. A FUNCTION OF AMBIENT TEMPERATURE

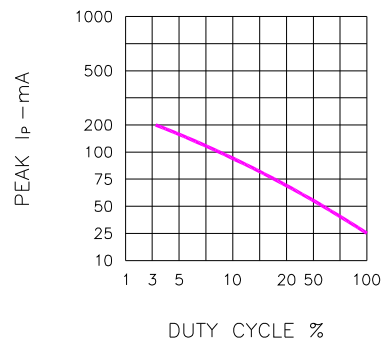

Fig.6 MAX PEAK CURRENT VS. DUTY CYCLE % (REFRESH RATE f=1 KHz)