

**2SB649/A**

**PNP SILICON TRANSISTOR**

**BIPOLAR POWER GENERAL PURPOSE TRANSISTOR**

■ APPLICATIONS

\* Low frequency power amplifier complementary pair with UTC 2SB669/A

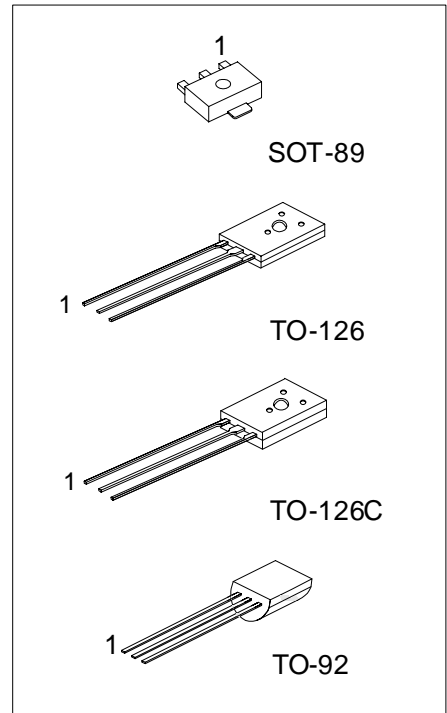

\*Pb-free plating product number:  
2SB649L/2SB649AL

■ ORDERING INFORMATION

Order Number		Package	Pin Assignment			Packing
Normal	Lead Free Plating		1	2	3	
2SB649-x-AB3-R	2SB649L-x-AB3-R	SOT-89	B	C	E	Tape Reel
2SB649-x-T6C-K	2SB649L-x-T6C-K	TO-126C	E	C	B	Bulk
2SB649-x-T60-K	2SB649L-x-T60-K	TO-126	E	C	B	Bulk
2SB649-x-T92-B	2SB649L-x-T92-B	TO-92	E	C	B	Tape Box
2SB649-x-T92-K	2SB649L-x-T92-K	TO-92	E	C	B	Bulk
2SB649A-x-AB3-R	2SB649AL-x-AB3-R	SOT-89	B	C	E	Tape Reel
2SB649A-x-T6C-K	2SB649AL-x-T6C-K	TO-126C	E	C	B	Bulk
2SB649A-x-T60-K	2SB649AL-x-T60-K	TO-126	E	C	B	Bulk
2SB649A-x-T92-B	2SB649AL-x-T92-B	TO-92	E	C	B	Tape Box
2SB649A-x-T92-K	2SB649AL-x-T92-K	TO-92	E	C	B	Bulk

<p>2SB649L-x-AB3-R</p>	<p>(1) Packing Type (2) Package Type (3) Rank (4) Lead Plating</p> <p>(1) B: Tape Box, K: Bulk, R: Tape Reel (2) AB3: SOT-89, T6C: TO-126C, T60: TO-126, T92: TO-92 (3) x: refer to Classification of <math>h_{FE}</math> (4) L: Lead Free Plating, Blank: Pb/Sn</p>
------------------------	--

■ ABSOLUTE MAXIMUM RATING (Ta=25 , unless otherwise specified)

PARAMETER		SYMBOL	RATING	UNIT
Collector-Base Voltage		$V_{CBO}$	-180	V
Collector-Emitter Voltage	2SB649	$V_{CEO}$	-120	V
	2SB649A		-160	
Emitter-Base Voltage		$V_{EBO}$	-5	V
Collector Current		$I_C$	-1.5	A
Collector Peak Current		$I_{C(PEAK)}$	-3	A
Collector Power Dissipation	TO-126/TO-126C	$P_D$	1.4	W
	TO-92		1	W
	SOT-89		500	mW
Junction Temperature		$T_J$	+150	°C
Storage Temperature		$T_{STG}$	-40 ~ +150	°C

Note: Absolute maximum ratings are those values beyond which the device could be permanently damaged.

Absolute maximum ratings are stress ratings only and functional device operation is not implied.

■ ELECTRICAL CHARACTERISTICS (Ta=25 , unless otherwise specified)

PARAMETER		SYMBOL	TEST CONDITIONS	MIN	TYP	MAX	UNIT
Collector to Base Breakdown Voltage		$BV_{CBO}$	$I_C=-1mA, I_E=0$	-180			V
Collector to Emitter Breakdown Voltage	2SB649	$BV_{CEO}$	$I_C=-10mA, R_{BE}=\infty$	-120			V
	2SB649A			-160			
Emitter to Base Breakdown Voltage		$BV_{EBO}$	$I_E=-1mA, I_C=0$	-5			V
Collector Cut-off Current		$I_{CBO}$	$V_{CB}=-160V, I_E=0$			-10	$\mu A$
DC Current Gain	2SB649	$h_{FE1}$	$V_{CE}=-5V, I_C=-150mA$ (note)	60		320	
		$h_{FE2}$	$V_{CE}=-5V, I_C=-500mA$ (note)	30			
	2SB649A	$h_{FE1}$	$V_{CE}=-5V, I_C=-150mA$ (note)	60		200	
		$h_{FE2}$	$V_{CE}=-5V, I_C=-500mA$ (note)	30			
Collector-Emitter Saturation Voltage		$V_{CE(SAT)}$	$I_C=-600mA, I_B=-50mA$			-1	V
Base-Emitter Voltage		$V_{BE}$	$V_{CE}=-5V, I_C=-150mA$			-1.5	V
Current Gain Bandwidth Product		$f_T$	$V_{CE}=-5V, I_C=-150mA$		140		MHz
Output Capacitance		$C_{ob}$	$V_{CB}=-10V, I_E=0, f=1MHz$		27		pF

Note: Pulse test.

■ CLASSIFICATION OF  $h_{FE}$

RANK	B	C	D
RANGE	60-120	100-200	160-320

### TYPICAL CHARACTERISTICS

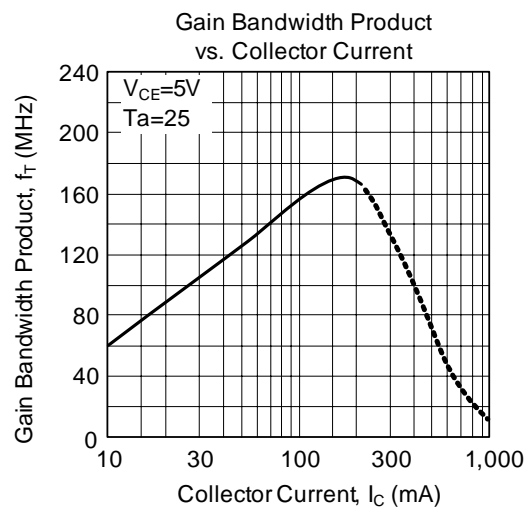
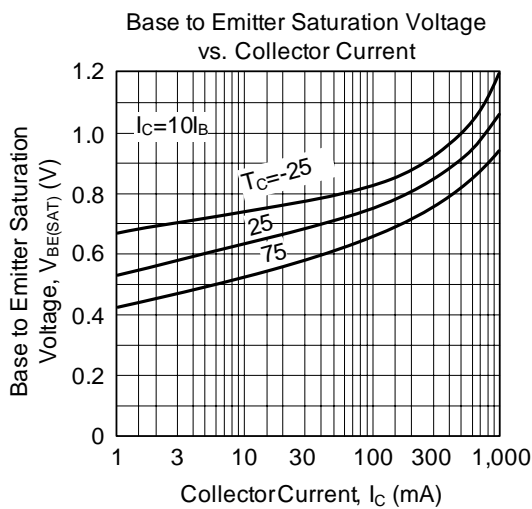
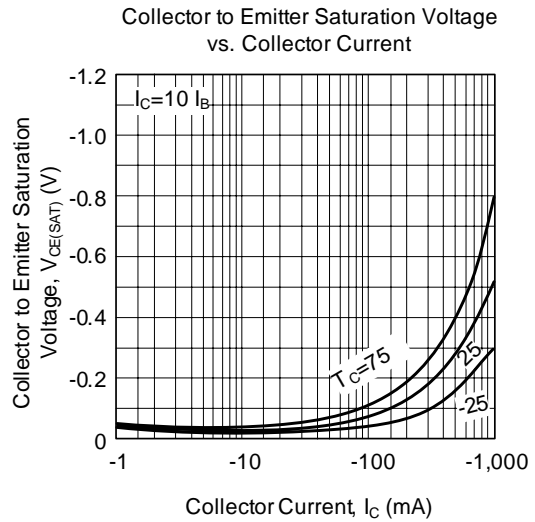
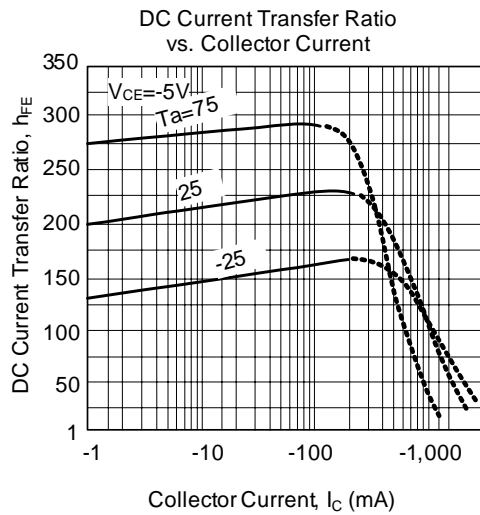
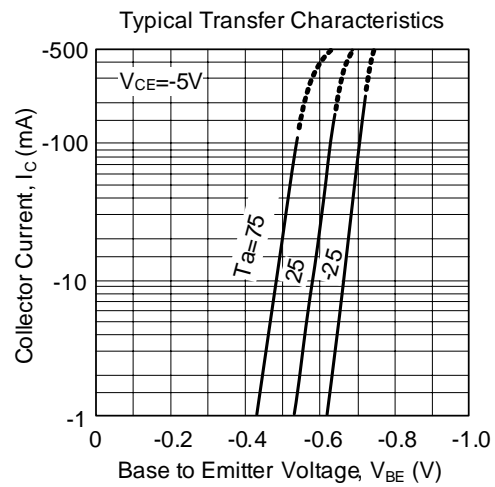
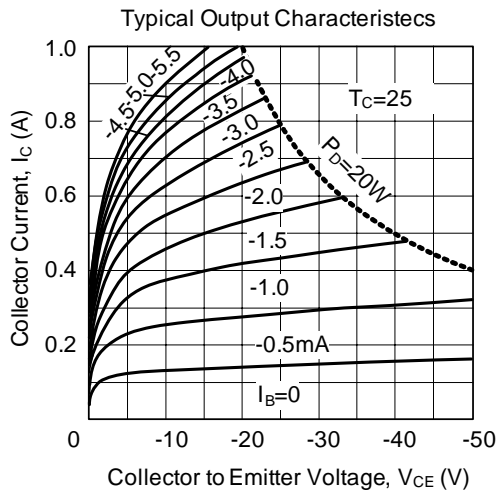

■ TYPICAL CHARACTERISTICS(Cont.)

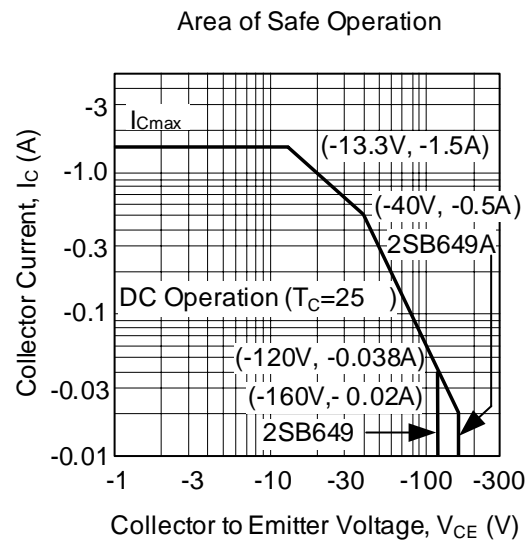
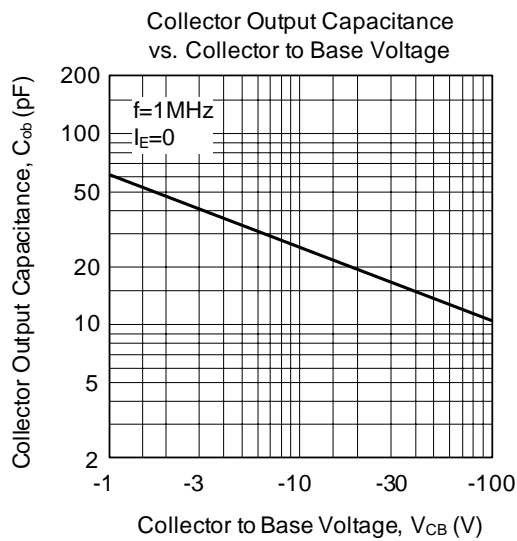

UTC assumes no responsibility for equipment failures that result from using products at values that exceed, even momentarily, rated values (such as maximum ratings, operating condition ranges, or other parameters) listed in products specifications of any and all UTC products described or contained herein. UTC products are not designed for use in life support appliances, devices or systems where malfunction of these products can be reasonably expected to result in personal injury. Reproduction in whole or in part is prohibited without the prior written consent of the copyright owner. The information presented in this document does not form part of any quotation or contract, is believed to be accurate and reliable and may be changed without notice.