

T-03-21

MOTOROLA SEMICONDUCTOR TECHNICAL DATA

**MR870 MR871
MR872 MR874
MR876**

Designers Data Sheet

**STUD MOUNTED
FAST RECOVERY POWER RECTIFIERS**

... designed for special applications such as dc power supplies, inverters, converters, ultrasonic systems, choppers, low RF interference, sonar power supplies and free wheeling diodes. A complete line of fast recovery rectifiers having typical recovery time of 150 nanoseconds providing high efficiency at frequencies to 250 kHz.

**FAST RECOVERY
POWER RECTIFIERS**

**50-600 VOLTS
50 AMPERES**



Designer's Data for "Worst Case" Conditions

The Designers Data sheets permit the design of most circuits entirely from the information presented. Limit curves - representing boundaries on device characteristics - are given to facilitate "worst case" design.

MAXIMUM RATINGS

Rating	Symbol	MR870	MR871	MR872	MR874	MR876	Unit
Peak Repetitive Reverse Voltage	V_{RRM}	50	100	200	400	600	Volts
Working Peak Reverse Voltage	V_{RWM}						
DC Blocking Voltage	V_R						
Non-Repetitive Peak Reverse Voltage	V_{RSM}	75	150	250	450	650	Volts
RMS Reverse Voltage	$V_R(RMS)$	35	70	140	280	420	Volts
Average Rectified Forward Current (Single phase, resistive load, $T_C = 100^\circ C$)	I_O	50					Amps
Non-Repetitive Peak Surge Current (surge applied at rated load conditions)	I_{FSM}	400					Amps
Operating Junction Temperature Range	T_J	-65 to +160					$^\circ C$
Storage Temperature Range	T_{stg}	-65 to +175					$^\circ C$

THERMAL CHARACTERISTICS

Characteristic	Symbol	Max	Unit
Thermal Resistance, Junction to Case	$R_{\theta JC}$	0.8	$^\circ C/W$

ELECTRICAL CHARACTERISTICS

Characteristic	Symbol	Min	Typ	Max	Unit
Instantaneous Forward Voltage ($I_F = 157$ Amp, $T_J = 160^\circ C$)	V_F	-	1.3	1.6	Volts
Forward Voltage ($I_F = 50$ Amp, $T_C = 25^\circ C$)	V_F	-	1.1	1.4	Volts
Reverse Current (rated dc voltage) $T_C = 25^\circ C$ $T_C = 100^\circ C$	I_R	-	25	50	μA mA

REVERSE RECOVERY CHARACTERISTICS

Characteristic	Symbol	Min	Typ	Max	Unit
Reverse Recovery Time ($I_F = 1.0$ Amp to $V_R = 30$ Vdc, Figure 16) ($I_{FM} = 36$ Amp, $di/dt = 25$ A/ μs , Figure 17)	t_{rr}	-	150	200	ns
Reverse Recovery Current ($I_F = 1.0$ Amp to $V_R = 30$ Vdc, Figure 16)	$I_{RM}(REC)$	-	2.0	3.0	Amp

MECHANICAL CHARACTERISTICS

CASE: Welded, hermetically sealed
FINISH: All external surfaces corrosion resistant and readily solderable

POLARITY: Cathode to Case
WEIGHT: 17 grams (approximately)
STUD TORQUE: 25 in. lbs.

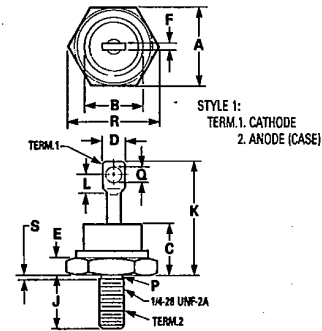

- NOTES:
1. DIM "P" IS DIA.
2. CHAMFER OR UNDERCUT ON ONE OR BOTH ENDS OF HEXAGONAL BASE IS OPTIONAL.
3. ANGULAR ORIENTATION AND CONTOUR OF TERMINAL ONE IS OPTIONAL.
4. THREADS ARE PLATED.
5. DIMENSIONING AND TOLERANCING PER ANSI Y14.5, 1973.

DIM	MILLIMETERS		INCHES	
	MIN	MAX	MIN	MAX
A	16.94	17.45	0.669	0.687
B	-	16.94	-	0.667
C	-	11.43	-	0.450
D	-	9.53	-	0.375
E	2.92	5.08	0.115	0.200
F	-	2.03	-	0.080
J	10.72	11.51	0.422	0.453
K	-	25.40	-	1.000
L	3.86	-	0.156	-
P	5.59	6.32	0.220	0.249
Q	3.56	4.45	0.140	0.175
R	-	20.16	-	0.794
S	-	2.26	-	0.089

**CASE 257-01
DO-203AB
METAL**

MR870, MR871, MR872, MR874, MR876

T-03-21

FIGURE 1 - FORWARD VOLTAGE

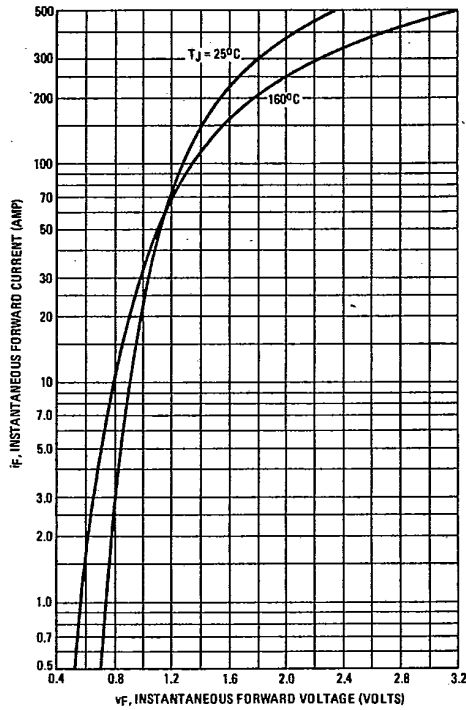
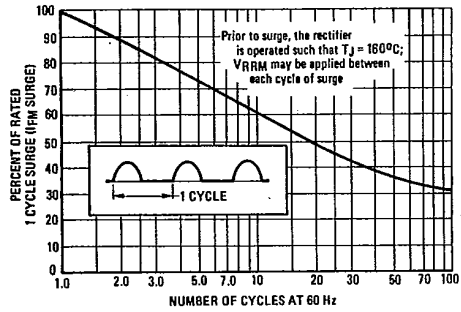

FIGURE 2 - MAXIMUM SURGE CAPABILITY



NOTE 1

DUTY CYCLE, $D = t_p/t_1$
 PEAK POWER, P_{pk} , is peak of an equivalent square power pulse.

To determine maximum junction temperature of the diode in a given situation, the following procedure is recommended:

The temperature of the case should be measured using a thermocouple placed on the case at the temperature reference point (see Note 3). The thermal mass connected to the case is normally large enough so that it will not significantly respond to heat surges generated in the diode as a result of pulsed operation once steady state conditions are achieved. Using the measured value of T_C , the junction temperature may be determined by:

$$T_J = T_C + \Delta T_{JC}$$

where ΔT_{JC} is the increase in junction temperature above the case temperature. It may be determined by:

$$\Delta T_{JC} = P_{pk} \cdot R_{\theta JC} [D + (1 - D) \cdot r(t_1 + t_p) + r(t_p) - r(t_1)]$$

where
 $r(t)$ = normalized value of transient thermal resistance at time, t , from Figure 3, i.e.:
 $r(t_1 + t_p)$ = normalized value of transient thermal resistance at time $t_1 + t_p$.



FIGURE 3 - THERMAL RESPONSE

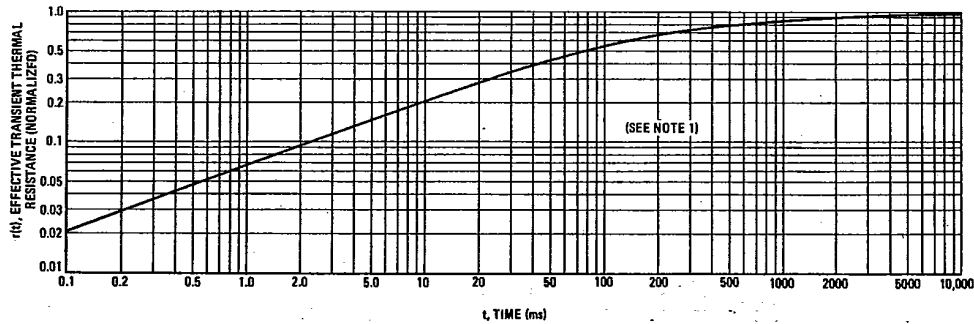

MR870, MR871, MR872, MR874, MR876

T-03-21

SINE WAVE INPUT

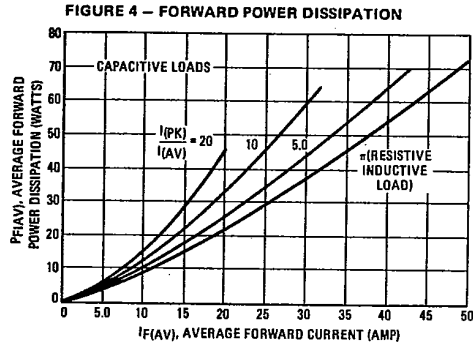

SQUARE WAVE INPUT

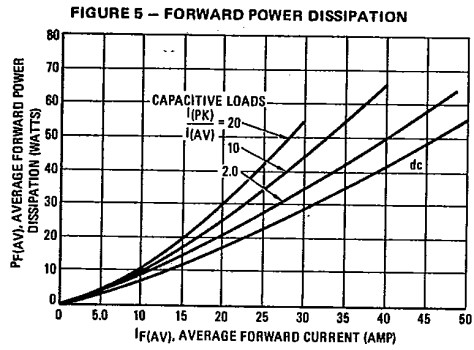

FIGURE 6 - CURRENT DERATING

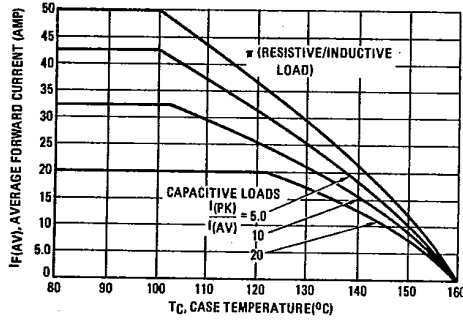

FIGURE 7 - CURRENT DERATING

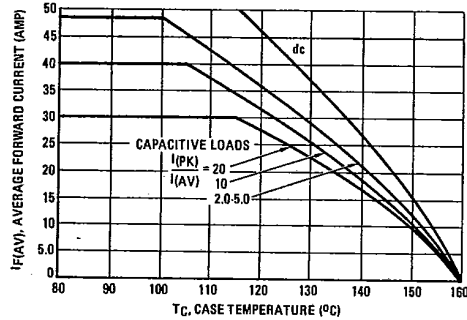

FIGURE 8 - TYPICAL REVERSE CURRENT

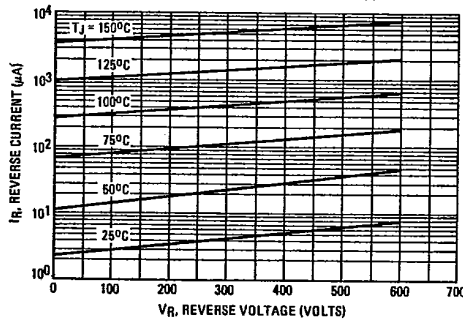
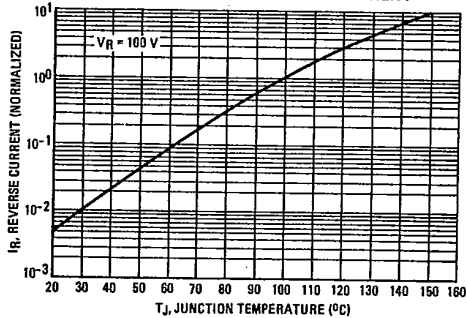

FIGURE 9 - NORMALIZED REVERSE CURRENT



MR870, MR871, MR872, MR874, MR876

T-03-21

TYPICAL DYNAMIC CHARACTERISTICS

FIGURE 10 - FORWARD RECOVERY TIME

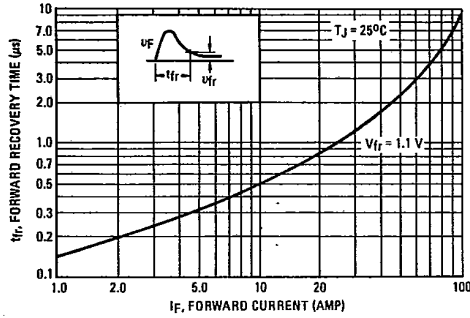
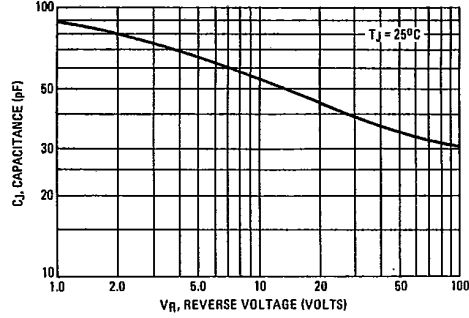

FIGURE 11 - JUNCTION CAPACITANCE



TYPICAL RECOVERED STORED CHARGE DATA

(See Note 2)

FIGURE 12 - Tj = 25°C

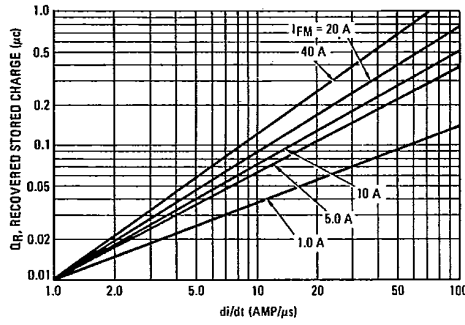

FIGURE 13 - Tj = 75°C

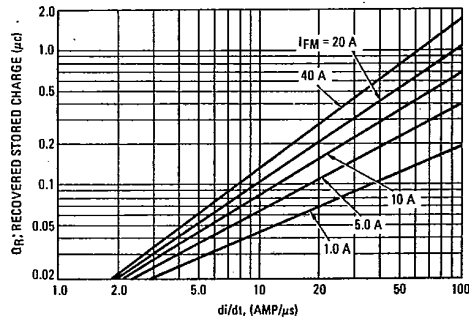

FIGURE 14 - Tj = 100°C

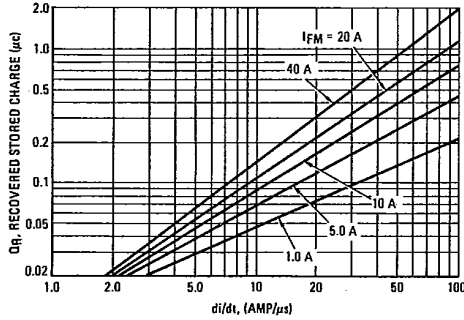
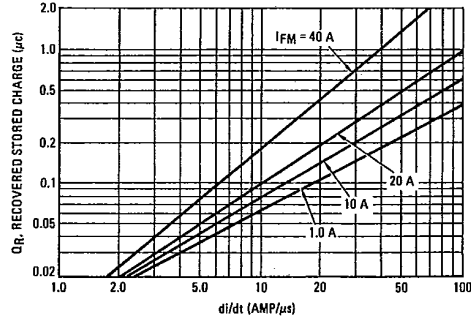

FIGURE 15 - Tj = 150°C



MR870, MR871, MR872, MR874, MR876

T-03-21

FIGURE 16 — JEDEC REVERSE RECOVERY CIRCUIT

- R1 = 50 Ohms
- R2 = 250 Ohms
- D1 = 1N4723
- D2 = 1N4001
- D3 = 1N4933
- SCR1 = HCR729-10
- C1 = 0.5 to 50 μ F
- C2 = 4000 μ F
- L1 = 1.0 - 27 μ H
- T1 = Variac Adjusts I_{PK} and di/dt
- T2 = 1:1
- T3 = 1:1 (to trigger circuit)

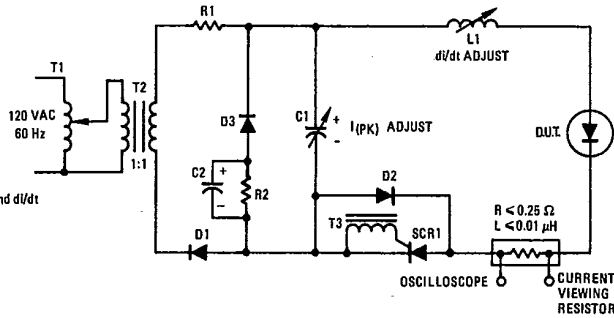

NOTE 2

Reverse recovery time is the period which elapses from the time that the current, thru a previously forward biased rectifier diode, passes thru zero going negatively until the reverse current recovers to a point which is less than 10% peak reverse current.

Reverse recovery time is a direct function of the forward current prior to the application of reverse voltage.

For any given rectifier, recovery time is very circuit dependent. Typical and maximum recovery time of all Motorola fast recovery power rectifiers are rated under a fixed set of conditions using $I_F = 1.0$ A, $V_R = 30$ V. In order to cover all circuit conditions, curves are given for typical recovered stored charge versus commutation di/dt for various levels of forward current and for junction temperatures of 25°C, 75°C, 100°C, and 150°C.

To use these curves, it is necessary to know the forward current level just before commutation, the circuit commutation di/dt , and the operating junction temperature. The reverse recovery test current waveform for all Motorola fast recovery rectifiers is shown.

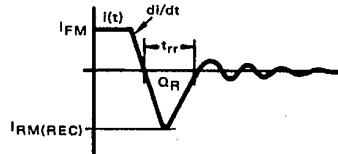

From stored charge curves versus di/dt , recovery time (t_{rr}) and peak reverse recovery current ($I_{RM(REC)}$) can be closely approximated using the following formulas:

$$t_{rr} = 1.41 \times \left[\frac{Q_R}{di/dt} \right]^{1/2}$$

$$I_{RM(REC)} = 1.41 \times [Q_R \times di/dt]^{1/2}$$