

HIGH ISOLATION VOLTAGE HIGH COLLECTOR TO EMITTER VOLTAGE SOP PHOTOCOUPLER

PS2732-1, -2, -4
PS2733-1, -2, -4

FEATURES

- **HIGH ISOLATION VOLTAGE**
BV: 2.5 k Vr.m.s. MIN
- **HIGH COLLECTOR TO EMITTER VOLTAGE**
V_{CEO}: 300 V MIN: PS2732-1,-2,-4
V_{CEO}: 350 V MIN: PS2733-1,-2,-4
- **SOP (SMALL OUT-LINE PACKAGE)**
- **ULTRA HIGH CURRENT TRANSFER RATIO**
CTR: 4000% TYP
- **TAPING PRODUCT NUMBER (Only -1 Type)**
PS2732-1-E3, F3
PS2733-1-E3, F3

DESCRIPTION

The PS2732 and PS2733 are optically coupled isolators containing a GaAs light emitting diode and an NPN silicon Darlington-connected phototransistor. Each is mounted in a plastic SOP (Small Out-line Package) for high density applications.

APPLICATIONS

Interface circuit for various instrumentations and control equipment.

- **REPLACEMENT FOR RELAY IN PULSE-DIAL CIRCUIT**
- **HIGH CTR CIRCUIT APPLICATIONS**

ELECTRICAL CHARACTERISTICS (T_A = 25°C)

PART NUMBER			PS2732-1, -2, -4, PS2733-1, -2, -4		
SYMBOLS	PARAMETERS	UNITS	MIN	TYP	MAX
Diode	V _F	Forward Voltage, I _F = 10 mA		1.15	1.4
	I _R	Reverse Current, V _R = 5 V			5
	C _t	Junction Capacitance, V = 0, f = 1.0 MHz		30	
Transistor	I _{CEO}	Collector to Emitter Dark Current, V _{CE} = 300 V, I _F = 0			400
Coupled	CTR	Current Transfer Ratio, I _F = 1 mA, V _{CE} = 2 V	1500	4000	
	V _{CE(sat)}	Collector Saturation Voltage, I _F = 1 mA, I _C = 2 mA			1.0
	R ₁₋₂	Isolation Resistance, V _{IN-OUT} = 1.0 k VDC	10 ¹¹		
	C ₁₋₂	Isolation Capacitance, V = 0, f = 1.0 MHz		0.4	
	t _r	Rise Time ¹ , V _{CC} = 5 V, I _C = 10 mA, R _L = 100 Ω		100	
	t _f	Fall Time ¹ , V _{CC} = 5 V, I _C = 10 mA, R _L = 100 Ω		100	

Note:

1. Test Circuit for Switching Time

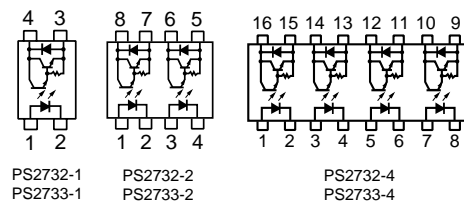
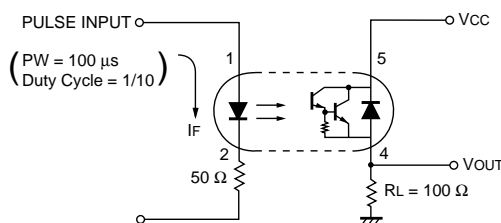

ABSOLUTE MAXIMUM RATINGS¹ (T_A = 25°C)

SYMBOLS	PARAMETERS	UNITS	RATINGS	
			PS2732-1 PS2733-1	PS2732-2,-4 PS2733-2,-4
Diode				
V _R	Reverse Voltage	V	6	6
I _F	Forward Current	mA	50	50
P _D	Power Dissipation	mW/Ch	80	80
I _F (PEAK)	Peak Forward Current (P _W = 100 μs, Duty Cycle 1%)	A	1	1
Transistor				
V _{CEO}	Collector to Emitter Voltage (I _C = 1mA, I _B = 0)	V	300/350	300/350
V _{EBO}	Emitter to Base Breakdown Volt (I _E = 100μA, I _B = 0)	V	6	6
I _C	Collector Current	mA/Ch	150	150
P _C	Power Dissipation	mW/Ch	150	120
Coupled				
BV	Isolation Voltage ²	V _{r.m.s.}	2500	
T _{OP}	Operating Temperature	°C	-55 to +100	
T _{STG}	Storage Temperature	°C	-55 to +150	

Notes:

1. Operation in excess of any one of these parameters may result in permanent damage.
2. AC voltage for 1 minute at T_A = 25 °C, RH = 60 % between input and output.

TYPICAL PERFORMANCE CURVES (T_A = 25 °C)

DIODE POWER DISSIPATION vs. AMBIENT TEMPERATURE

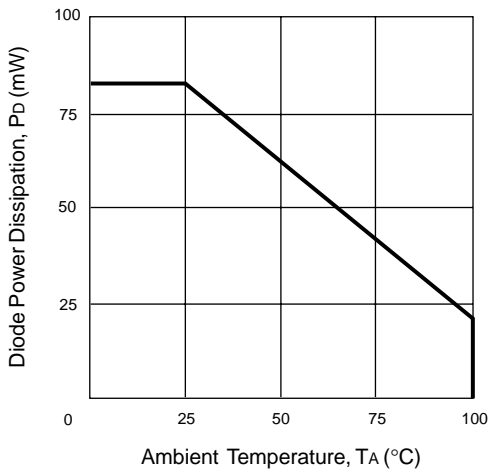

TRANSISTOR POWER DISSIPATION vs. AMBIENT TEMPERATURE

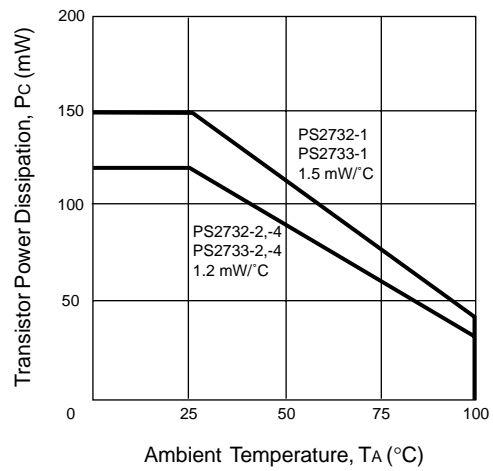

FORWARD CURRENT vs. FORWARD VOLTAGE

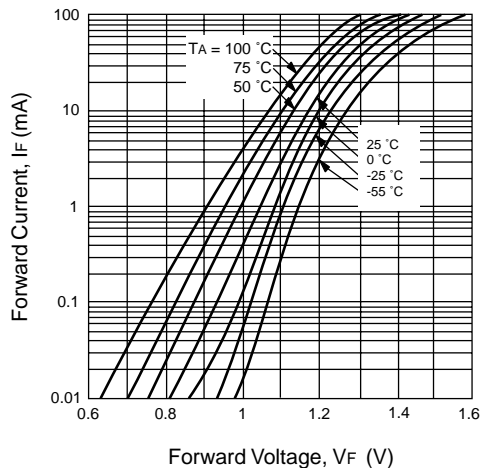

COLLECTOR CURRENT vs. COLLECTOR TO EMITTER VOLTAGE

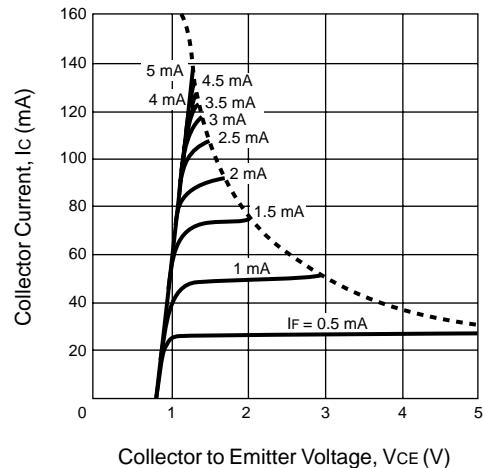

TYPICAL PERFORMANCE CURVES ($T_A = 25\text{ }^\circ\text{C}$)

COLLECTOR TO EMITTER DARK CURRENT vs. AMBIENT TEMPERATURE

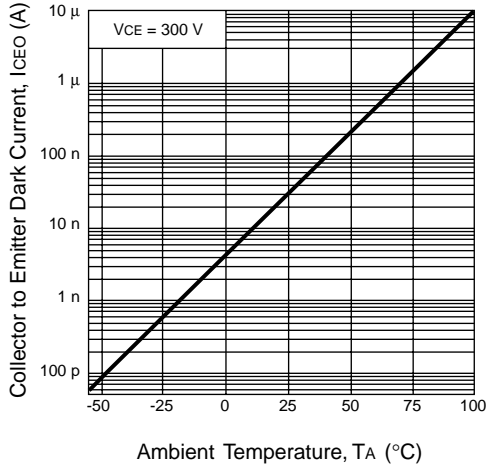

COLLECTOR CURRENT vs. COLLECTOR SATURATION VOLTAGE

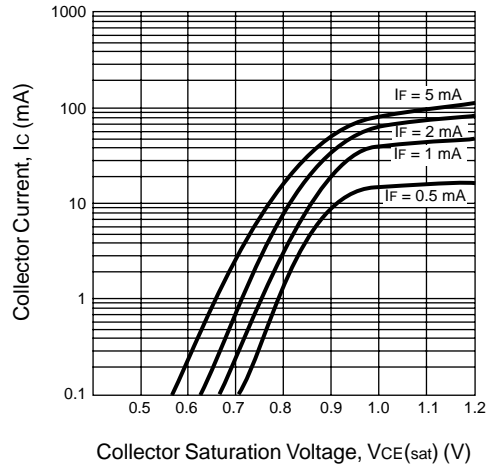

NORMALIZED OUTPUT CURRENT vs. AMBIENT TEMPERATURE

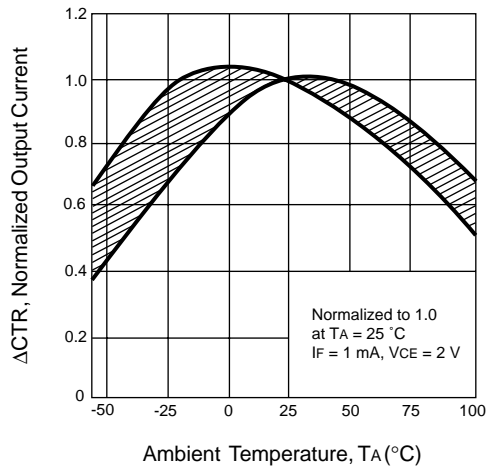

CURRENT TRANSFER RATIO (CTR) vs. FORWARD CURRENT

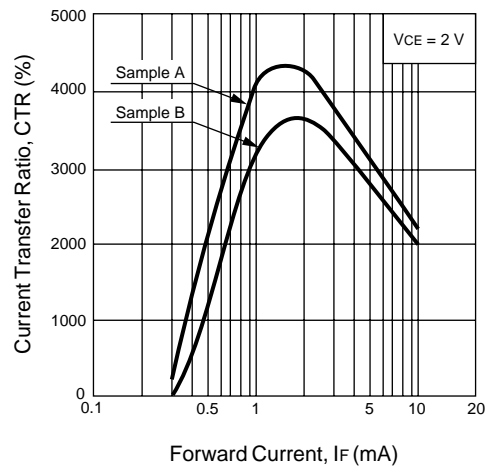

SWITCHING TIME vs. LOAD RESISTANCE

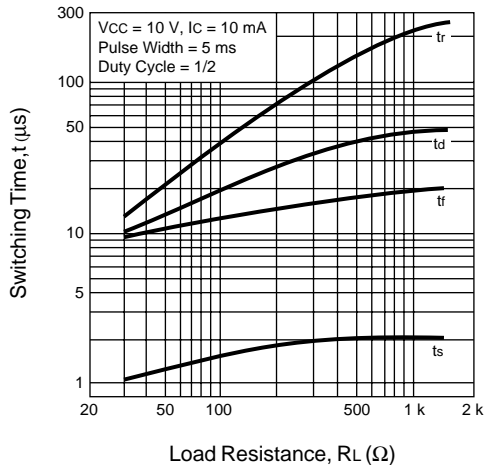

FREQUENCY RESPONSE

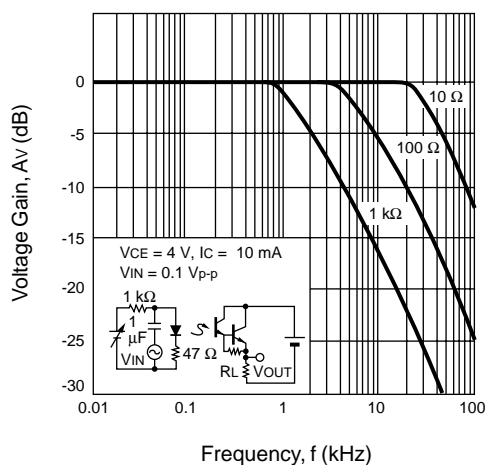

TYPICAL PERFORMANCE CURVES (TA = 25 °C)

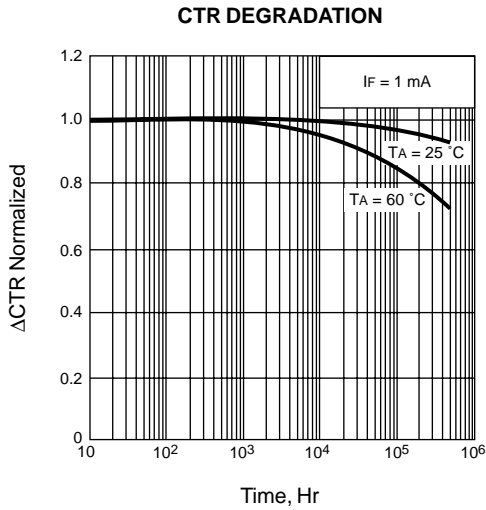

OUTLINE DIMENSIONS (Units in mm)

PS2732-1, PS2733-1

PIN CONNECTION
(Top View)

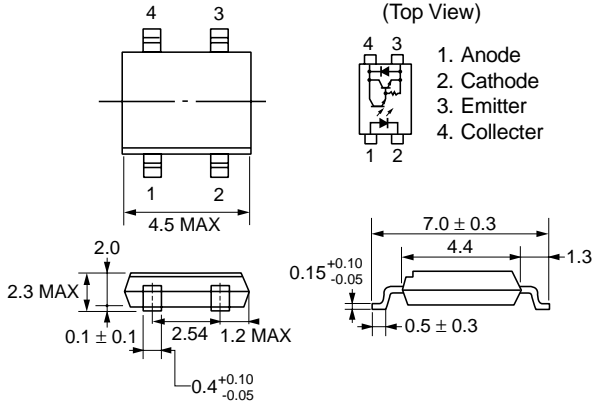

PS2732-2, PS2733-2

PIN CONNECTION
(Top View)

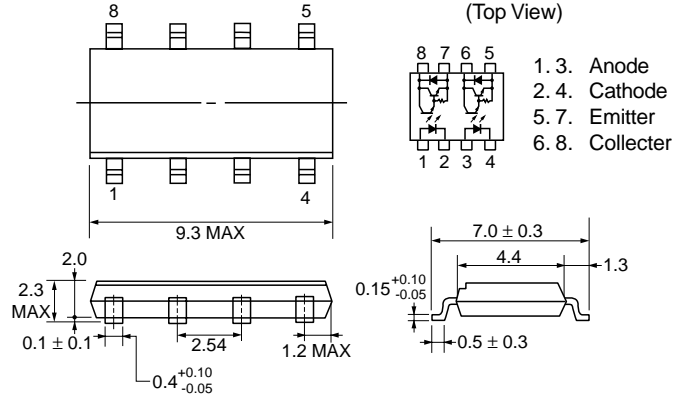

PS2732-4, PS2733-4

PIN CONNECTION
(Top View)

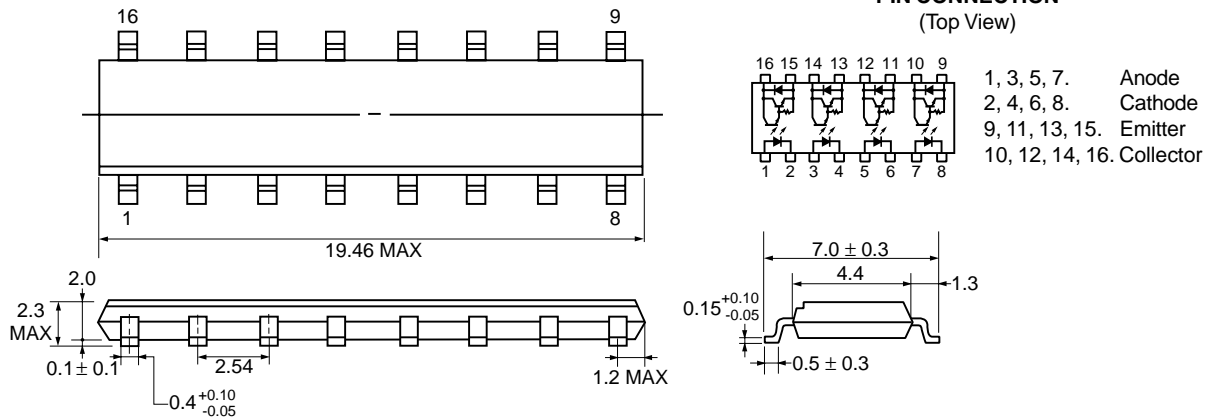

EXCLUSIVE NORTH AMERICAN AGENT FOR **NEC** RF, MICROWAVE & OPTOELECTRONIC SEMICONDUCTORS

CEL CALIFORNIA EASTERN LABORATORIES • Headquarters • 4590 Patrick Henry Drive • Santa Clara, CA 95054-1817 • (408) 988-3500 • Telex 34-6393 • FAX (408) 988-0279
 24-Hour Fax-On-Demand: 800-390-3232 (U.S. and Canada only) • Internet: <http://WWW.CEL.COM>

DATA SUBJECT TO CHANGE WITHOUT NOTICE

7/26/2000