

"HALF-BRIDGE" IGBT INT-A-PAK

Fast Speed IGBT

- Rugged Design
- Simple gate-drive
- Fast operation up to 10KHz hard switching, or 50KHz resonant
- Switching-Loss Rating includes all "tail" losses

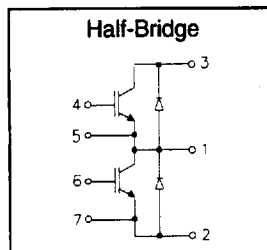

$$V_{CE} = 600V$$

$$I_C = 65A$$

$$V_{CE(ON)} < 2.3V$$

Description

IR's advanced IGBT technology is the key to this line of INT-A-pak Power Modules. The efficient geometry and unique processing of the IGBT allow higher current densities than comparable bipolar power module transistors, while at the same time requiring the simpler gate-drive of the familiar power MOSFET. This superior technology has now been coupled to state of the art assembly techniques to produce a higher current module that is highly suited to power applications such as motor drives, uninterruptible power supplies, welding, induction heating and ultrasonics.

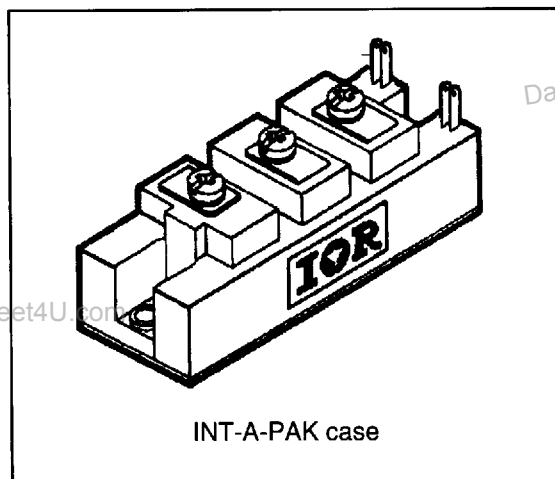

Absolute Maximum Ratings

Parameter	Description	Value	Units
V_{CES}	Continuous collector to emitter voltage	600	V
$I_C @ T_C = 25^\circ C$	Continuous collector current	65	A
$I_C @ T_C = 85^\circ C$	Continuous collector current	40	
$I_C @ T_C = 100^\circ C$	Continuous collector current	35	
I_{LM}	Peak switching current	130	
I_{FM}	Peak diode forward current (1)	165	
V_{GE}	Gate to emitter voltage	± 20	V
V_{ISOL}	RMS isolation voltage, any terminal to case, $t = 1$ min	2500	
$P_D @ T_C = 25^\circ C$	Power dissipation	179	W
T_J	Operating junction temperature range	-40 to 150	$^\circ C$
T_{STG}	Storage temperature range	-40 to 125	

(1) Duration limited by max junction temperature.

Electrical Characteristics - $T_J = 25^\circ\text{C}$, unless otherwise stated

Parameter	Description	Min	Typ	Max	Units	Test Conditions
BV_{CES}	Collector-to-emitter breakdown voltage	600	—	—	V	$V_{GE} = 0V, I_C = 500\mu A$
$V_{CE(ON)}$	Collector-to-emitter voltage	—	—	2.3		$V_{GE} = 15V, I_C = 65A$
		—	2.6	—		$V_{GE} = 15V, I_C = 65A, T_J = 150^\circ\text{C}$
V_{FM}	Diode forward voltage - maximum	—	—	3.2		$I_F = 65A, V_{GE} = 0V$
		—	3.2	—		$I_F = 65A, V_{GE} = 0V, T_J = 150^\circ\text{C}$
V_{GEth}	Gate threshold voltage	3.0	—	5.5	$I_C = 250\mu A$	
ΔV_{GEth}	Threshold voltage temp. coeff.	—	-11	—	mV/°C	$V_{CE} = V_{GE}, I_C = 250\mu A$
g_{fe}	Forward transconductance	26	—	36	S(Ω)	$V_{CE} = 25V, I_C = 65A$
I_{CES}	Collector-to-emitter leakage current	—	—	500	μA	$V_{GE} = 0V, V_{CE} = 600V$
		—	—	5	mA	$V_{GE} = 0V, V_{CE} = 600V, T_J = 150^\circ\text{C}$
I_{GES}	Gate-to-emitter leakage current	—	—	± 500	nA	$V_{GE} = \pm 20V$

Dynamic Characteristics - $T_J = 150^\circ\text{C}$

Parameter	Description	Min	Typ	Max	Units	Test Conditions
E_{on}	Turn-on switching energy	—	0.05	—	mJ/A	$R_{G1} = 82\Omega, R_{G2} = 0\Omega$
$E_{off} (1)$	Turn-off switching energy	—	0.17	—		$I_C = 65A, L_S = 100nH$
$E_{ts} (1)$	Total switching energy	—	—	0.3		$V_{CC} = 360V, V_{GE} = \pm 15V$
$t_{d(on)}$	Turn-on delay time	—	80	—	ns	$R_{G1} = 82\Omega, R_{G2} = 0\Omega$
t_r	Rise time	—	150	—		$I_C = 65A$
$t_{d(off)}$	Turn-off delay time	—	450	—		$V_{CC} = 360V, V_{GE} = \pm 15V$
t_f	Fall time	—	900	—		$L_S = 100nH$
I_{rr}	Diode peak recovery current	—	30	—	A	$R_{G1} = 82\Omega, R_{G2} = 0\Omega$
t_{rr}	Diode recovery time	—	115	—	ns	$I_C = 65A$
Q_{rr}	Diode recovery charge	—	2.0	—	μC	$V_{CC} = 360V, V_{GE} = \pm 15V$
Q_{ge}	Gate-to-emitter charge (turn-on)	77	—	140	nC	$V_{CC} = 360V$
Q_{gc}	Gate-to-collector charge (turn-on)	35	—	70		$I_C = 65A$
Q_g	Total gate charge (turn-on)	13	—	21		$V_{GE} = 15V$
C_{ies}	Input capacitance	—	2900	—	pF	$V_{GE} = 0V$
C_{oes}	Output capacitance	—	330	—		$V_{CC} = 30V$
C_{res}	Reverse transfer capacitance	—	40	—		$f = 1MHz$

(1) Includes tail losses

Thermal and Mechanical Characteristics

Parameter	Description	Typ	Max	Units
R_{thJC} (IGBT)	Thermal resistance, junction to case, each IGBT	—	0.7	°C/W
R_{thJC} (Diode)	Thermal resistance, junction to case, each diode	—	1.3	
R_{thCS} (Module)	Thermal resistance, case to sink	0.1	—	
Wt	Weight of module	140	—	g



IRGT1065F06

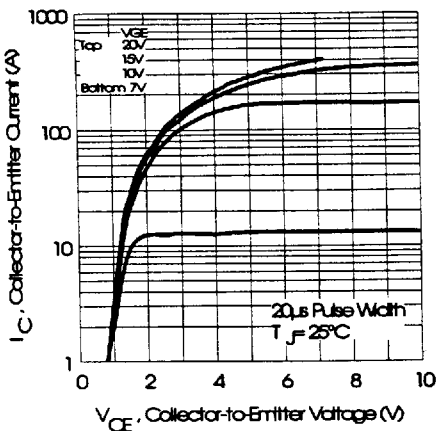

Fig. 1 - Typical Output Characteristics, $T_j = 25^\circ\text{C}$

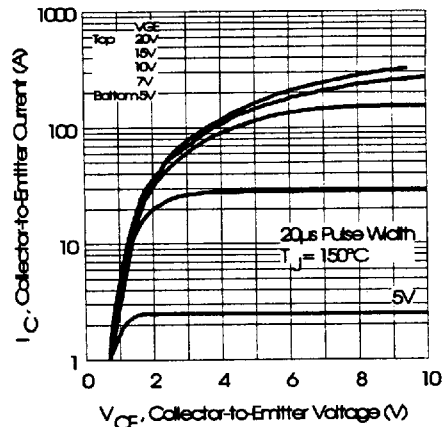

Fig. 2 - Typical Output Characteristics, $T_j = 150^\circ\text{C}$

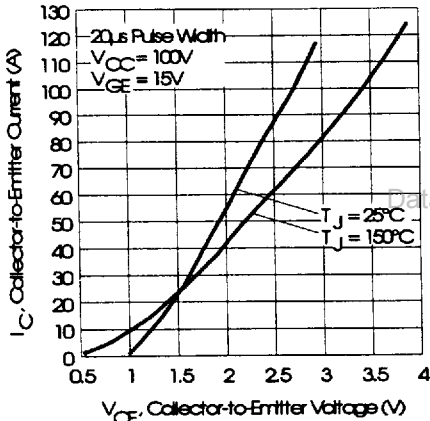

Fig. 3 - Typical Output Characteristics

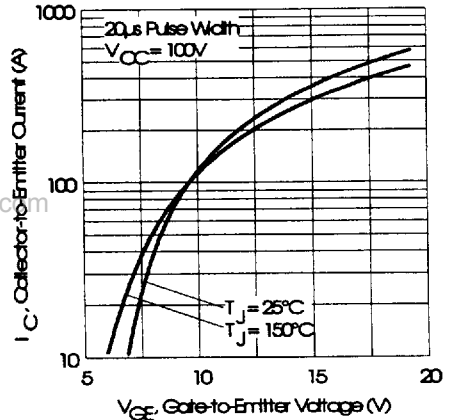

Fig. 4 - Typical Transfer Characteristics

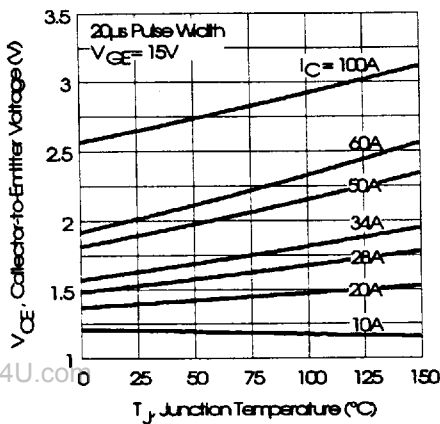

Fig. 5 - Collector-to-Emitter Saturation Typical Voltage vs. Junction Temperature

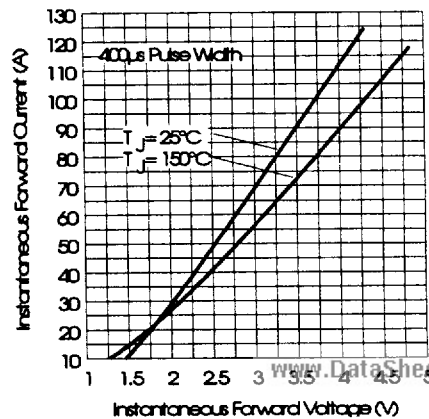

Fig. 6 - Forward Voltage Drop Characteristics

IRGT1065F06

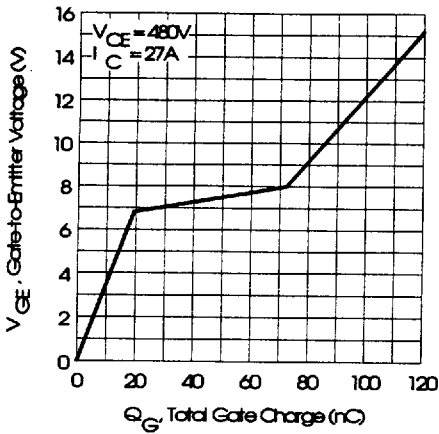

Fig. 7 - Typical Gate Charge vs. Gate-to-Emitter Voltage

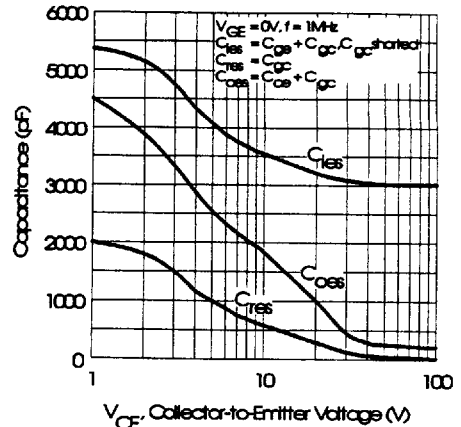

Fig. 8 - Typical Capacitance vs. Collector-to-Emitter Voltage

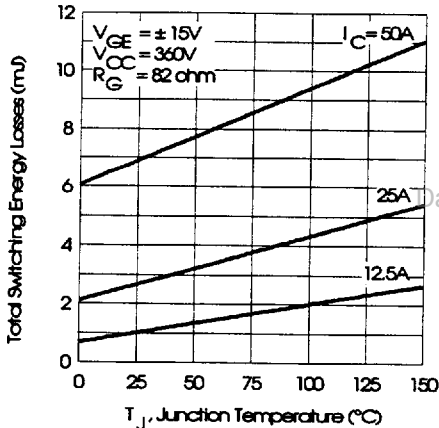

Fig. 9 - Typical Switching Losses vs. Junction Temperature

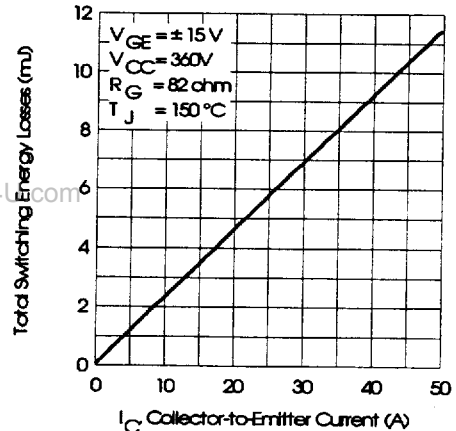

Fig. 10 - Typical Switching Losses vs. Collector-to-Emitter Current

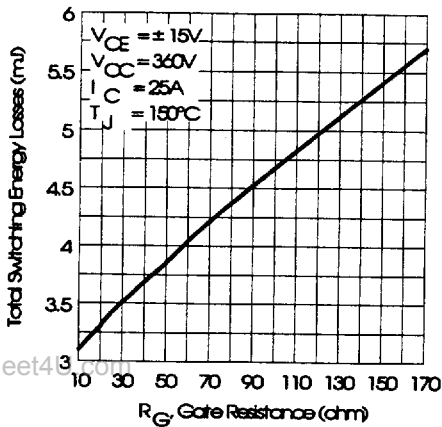

Fig. 11 - Typical Switching Losses vs. Gate Resistance

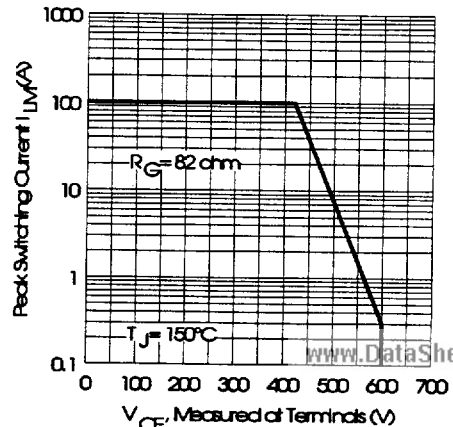

Fig. 12 - Reverse Bias Safe Operating Area

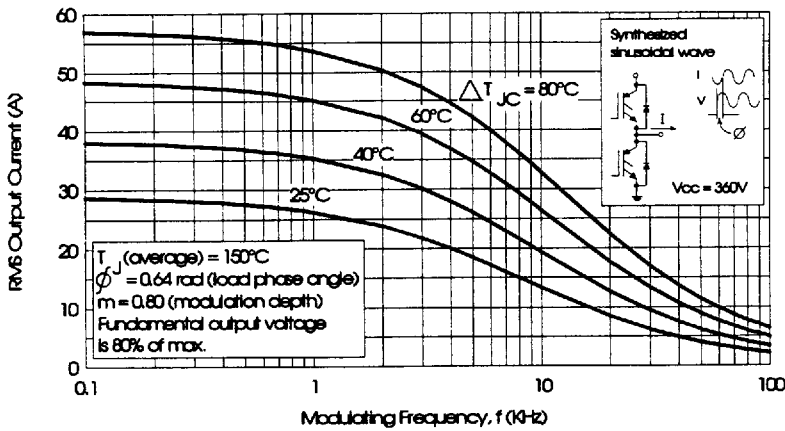

Fig. 13 - Typical RMS Output Current per phase vs. Frequency (Synthesized Sinusoidal Wave)

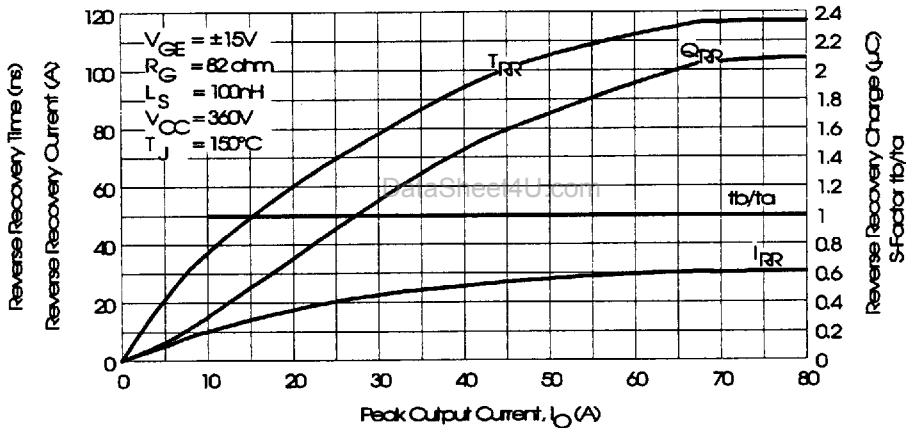

Fig. 14 - Typical Diode Recovery Characteristics as Function of Output Current I_o

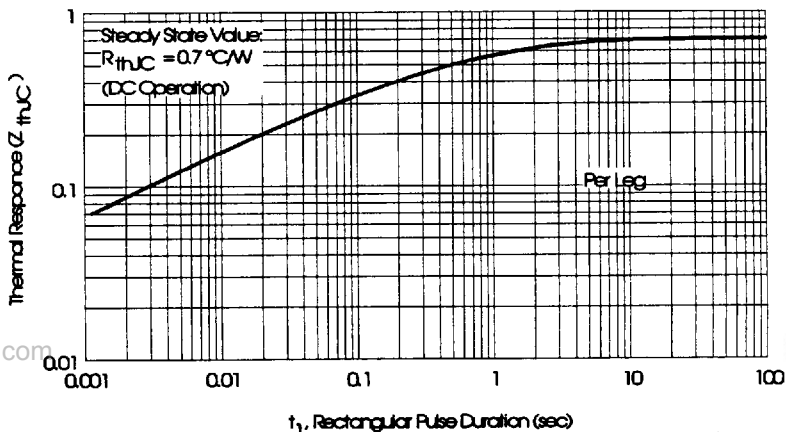

Fig. 15 - Maximum Effective Transient Thermal Impedance, Junction-to-Case

Power
Conversion
Fast
Products

DataSheet4U.com

et4U.com

DataSheet4U.com

www.DataSheet4U.com

DataSheet4U.com

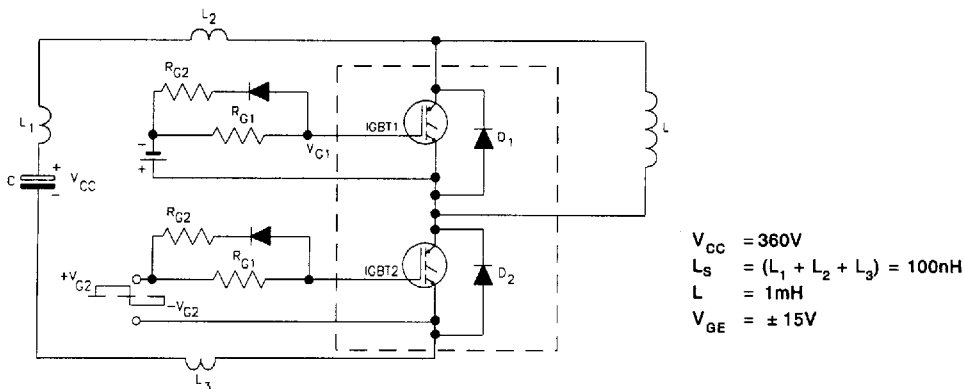

Fig. 16 - Test Circuit for Measurement of I_{LM} , E_{ON} , E_{OFF} , Q_{RR} , I_{RR} , $t_{D(ON)}$, t_r , $t_{D(OFF)}$, t_f

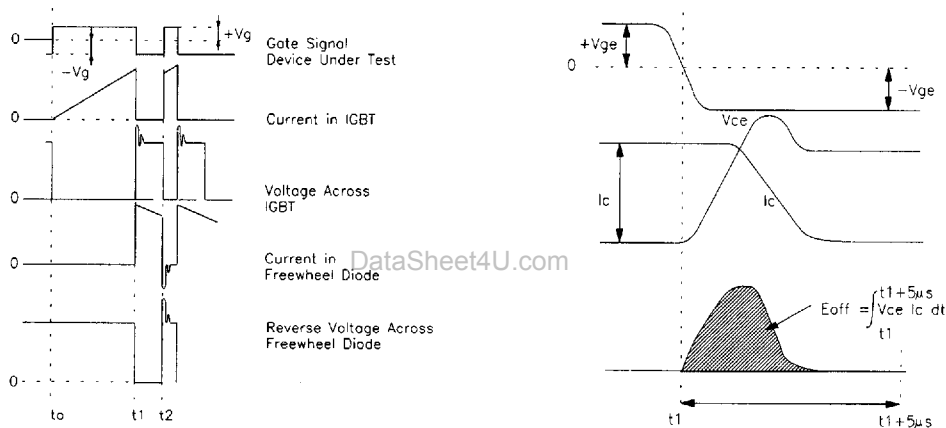

Fig. 17 - Test Waveforms for Circuit of Fig. 16

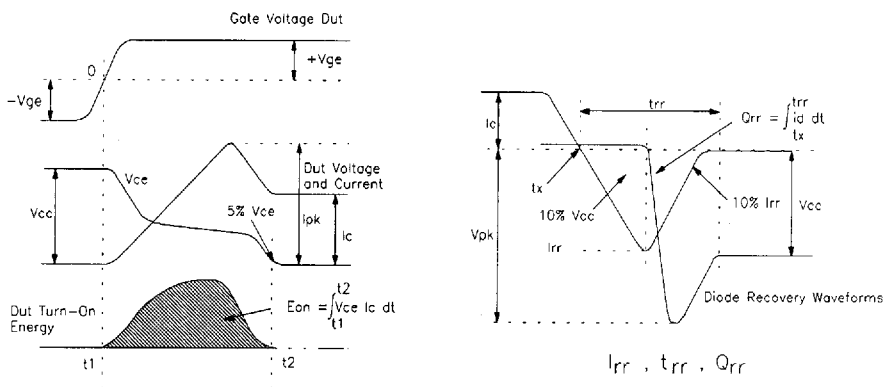

Fig. 18 - Test Waveforms for Circuit of Fig. 16, Defining E_{ON} , E_{REC} , $t_{D(ON)}$, t_r , I_{RR} , t_{RR} , Q_{RR}

Refer to Section D for the following:

Appendix E: Section D - page D-7

Fig. 19 - Waveforms for Switching Time

Package Outline 10 - INT-A-PAK Half Bridge Section D - page D-16